



PRODUCT OVERVIEW

2024-2025





HELLA: AN EXPERT PARTNER TO THE AFTERMARKET AND GARAGES

In the aftermarket the brand name of HELLA stands for a wide and attractive range of products, for professional workshop equipment and for first-class service, all from a single source. These three core competencies together form the HELLA Parts, Tools and Services concept.

IMPORTANT: CATALOG PART NUMBERS

Dear customers,

In this catalog edition you will find "Catalog Part Number" indicated inside a parenthesis in the right side and "HELLA Internal Part Number", text indicated in bold font. The two different part numbers apply for the same product.

Your HELLA Team

CONTENT

1. HELLA GROUP | 4



2. LIGHTING | 6



- Auxiliary Lighting | 6
- Conversion Headlights | 48
- Lighting Modules | 50
- Shapeline Lighting | 56
- HELLA VALUEFIT Product Range | 58
- Worklights | 82
- Optical Warning Systems | 92
- HELLA MINING | 106
- HELLA MARINE | 107
- Specific Vehicle Lighting | 108
- Bulbs | 126
- LED Bulbs | 140
- Bulbs Product Range | 146
- Halogen Bulbs | 148
- Miniature Bulbs | 156
- High Intensity Discharge Bulbs | 170
- Special Halogen Bulbs | 172
- Motorcycle Bulbs | 184

3. WIPER BLADES | 200



- HELLA Wiper Blades Range | 200
- Standard Wiper Blades | 204
- Cleantech 2.0 Wiper Blades | 206
- Rear Wiper Blades | 208
- Rear Wiper Blades for Specific Vehicles | 210
- Hybrid Wiper Blades | 212
- Winter Blades | 214
- Heavy Duty Wiper Blades | 216
- Electrical Water Pumps | 218
- Relays, Tanks, | 218

4. ELECTRICS | 220



- Acoustic Signal Units | 222
- Backup alarms | 238
- Relays | 242
- Flashers | 254
- Relay Socket | 255
- Fuses, Fuse Holders | 257
- Main Battery Switches | 261

5. ELECTRONICS | 262



- Electronics Product Overview | 262
- Highlighted Products | 266
- Fuel Pumps | 268

6. HELLA PAGID BRAKE | 270



7. DIGITAL SERVICES | 274



8. TECH INFORMATION | 276



Our catalog gives you an overview and detail of the full range of products. For more details and other applications, please see our websites:

www.myhellalights.com
<https://hella.mypartfinder.com>

HELLA GROUP FACTS



HELLA at a glance

HELLA is listed as an internationally positioned automotive supplier under the FORVIA umbrella. HELLA stands for high-performance lighting technology and automotive electronics within this de facto group. At the same time, the Company covers a broad service and product portfolio for the spare parts and workshop business and manufacturers of special-purpose vehicles with its Business Group Lifecycle Solutions.

37,500

Employees world wide

7th

Largest automotive technology supplier

125+

Locations world wide

8,000

People working in research and development



FREEDOM IS WHAT YOU DO!

HELLA auxiliary lamps can cope with all expeditions and adventures, regardless of how rugged the terrain or the extreme weather.



HELLA AUXILIARY LIGHTING

When it comes to accessories, HELLA is always the right partner. For many years, our lighting experience has been reflected in the most varied innovations. With our wide range of auxiliary lamps, reversing lights, work lights, daytime running lights and interior lights, as well as side marker lights and interior lighting, we are one of the leading suppliers in the market. As the use of LED technology increases, HELLA strives to be at the forefront of new ideas and technologies.

More light? Of course! Should we turn night into day for you, or do you want to see the road clearly in front of you, even when the weather is bad? Our auxiliary lights stand out for their legendary performance and quality, and for the spotlights that continue to improve we offer greater safety, lighting your way ideally, whether by fog lights, long, short and wide-range spotlights.

ELIVER - Online comparison tool for light distribution



www.hella.com/eliver



HELLA VALUEFIT: Proven quality at an excellent price



HELLA VALUEFIT is a specific range of auxiliary lighting fixtures, designed exclusively to meet customer requirements. HELLA VALUEFIT products offer reliable quality at a fair price. In addition, HELLA has combined decades of technological knowledge with a unique business experience. As a result, all lighting fixtures meet the relevant technical specifications, are safe, reliable and easy to install.

In addition, there is no need to dispense with important services. HELLA VALUEFIT products offer genuine added value and proven quality at an excellent price!

Microsite - Meet the HELLA and HELLA VALUEFIT lighting product range



www.myhellalights.com

KNOWLEDGE OF LIGHT AND POWER

Innovations from HELLA. With HELLA, you opt for products with uncompromising quality. We work every day to make our lighting solutions even better and safer. As a result of our relentless innovative energy, we are among the first, best and even the sole suppliers or manufacturers in many areas of vehicle and lighting technology. We are currently pleased to be playing a particularly strong pioneering role with our Rallye LED using 100% LED technology.

Research and development. As in the field of stress testing where we test our products on the durability of the material and light source, HELLA lamps undergo continuous quality and performance tests for light distribution and radiation intensity. They are granted approval under the type approval requirements of the EU approval process. Different tasks require different lamps. The result is lamps of the highest quality – perfectly matched to the most diverse requirements under extreme conditions.

RADIATION INTENSITY



LIGHT DISTRIBUTION SHOULD BE CONSIDERED OBJECTIVELY.

Different applications require different auxiliary lights. The Isolux diagrams show a comparison of light distributions. The red-orange coloring marks the area with high illumination intensity. From yellow through green to blue, the illumination intensity decreases depending on distance. Fog light radiation is wide but not over a long distance (to avoid, as far as possible, reflection through fog droplets).

THE LUX UNIT

As a unit of illuminance, Lux defines the luminous flux from a light source that hits a specified surface. For example, an office should be illuminated with at least 500 Lux and with just 1 Lux the human eye

can read a newspaper without any problem. The values along the Lux bar show where the respective illuminance is achieved in the light distribution diagrams.

THE HIGH-BOOST REFLECTOR

High-boost reflectors are specially developed by HELLA to provide maximum light output. Compared to standard commercial auxiliary lights of similar size, HELLA auxiliary lights with high-boost reflectors deliver a much higher degree of efficiency with improved light output.

THE "REF." REFERENCE NUMBER

The reference number is a value applicable to spotlights. According to the ECE Regulation in effect since 2009, the sum of the reference numbers of all the installed

lamps must not exceed the upper limit of 100 per vehicle. The two values of the standard high beam (left and right main lamps) plus the values of any other extra spotlights are added together. The reference number of HELLA spotlights as well as the E-type approval mark can be found in the catalog for each model. A high beam with a 17.5 reference number emits a wide and full beam, but not as much as a high beam with a 37.5 reference number. A high beam Ref. 37.5 is therefore ideal for long, straight distances, while a high beam Ref. 17.5 can illuminate curved routes (especially mountainous areas) better.

Note: In some countries, a maximum high beam power of only 75 (reference value) may be connected. In those countries, the

high beam integrated into the vehicle must be inoperative when using the Ref. 37.5 high beam; however, the Ref. 17.5 high beam can generally be connected in addition.

CELIS® light guides

With CELIS® technology (Central Lighting Systems), fibreglass cables or thin plastic rods transport the light from a central light source to where it is required.

ECE & SAE APPROVALS

ECE Approval:

The World Forum of Vehicle Regulations is a working party of the United Nations Economic Commission of Europe (ECE). It is tasked with creating a uniform set of regulations for vehicles, which makes them legal on the streets of participating countries.

SAE APPROVAL:

The USA has its own set of standards, which are called the Federal Motor Vehicle Safety Standards (FMVSS), which are based on proposals of the Society of Automotive Engineers (SAE). The USA does not recognize ECE approvals.

Canada has its own Canada Motor Vehicle Safety Standards (CMVSS), broadly similar to FMVSS, but Canada does also accept ECE-compliant headlamps

AUXILIARY LIGHTING

Illumination and Isolux diagrams

Using Isolux diagrams, we can illustrate and compare light distributions. The red-orange color indicates the area of high intensity illumination; the illuminance falls from yellow to green to blue depending on the distance from the light source.

Rallye 4000 Metal LED
with Ref. 40

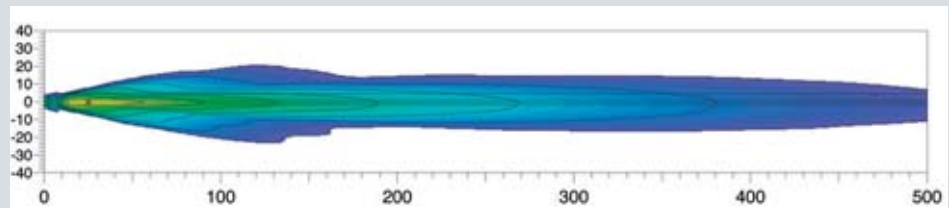

Rallye 40000i Xenon
with Ref. 37.5

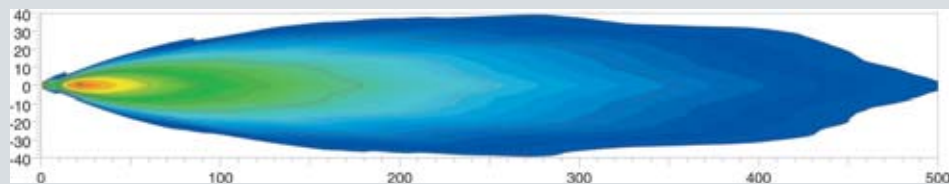

Rallye 4000 Halogen
with Ref. 17.5

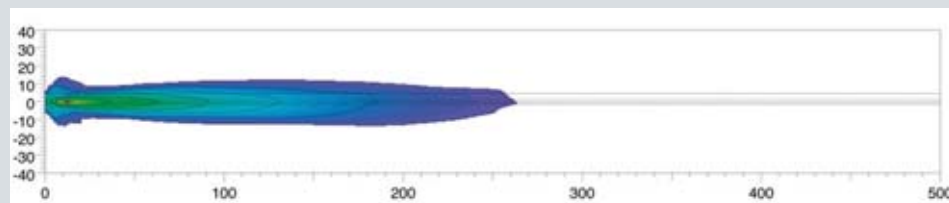

FOG LAMP

Fog lamp HELLA 500
with Ref. 12.5

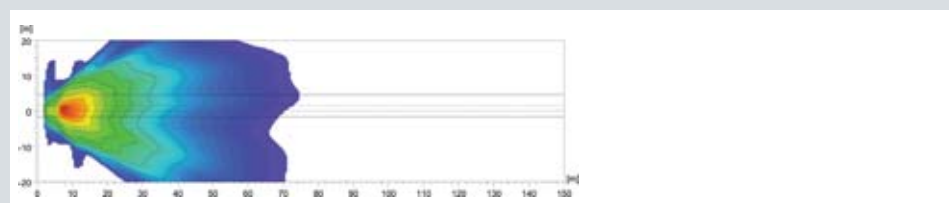



HELLA X-TREME LED CUBES



TAKE YOUR OFF-ROAD ADVENTURE TO THE X-TREME









The all-new HELLA X-TREME Driving Lamp Cube Sets, available in 4" and 3" sizes, are engineered to leave nothing in the dark. With a staggering 7,100 lumens (4") and 5,700 lumens (3") powered by four high-output LED modules, these lamps redefine visibility on the road. Featuring an innovative, first-to-market "X" position light design that offers the versatility of white or amber illumination, the 4.3" model goes a step further with a lateral position light that doubles as a side signal. Illuminate your path with HELLA's unmatched performance and cutting-edge design.

HELLA X-TREME LED CUBES

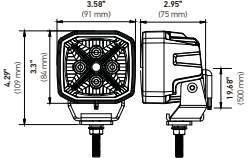

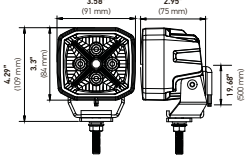

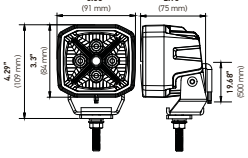

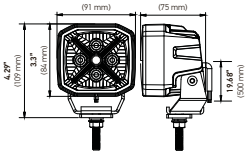

- Innovative "X" LED position light in white or amber
- White or Amber PO: For individual, attention-grabbing vehicle styling (off-road use)
- In two sizes and designs with shallow mounting depth
- Remarkable 7100 lumens (4") and 5700 lumens (3") light output



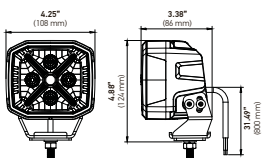

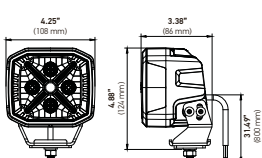

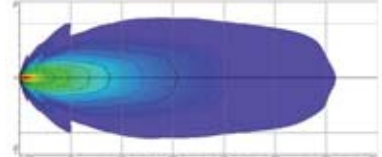
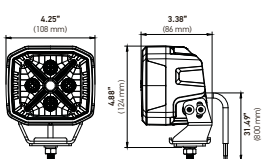

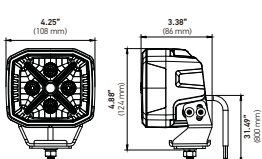
NEW!

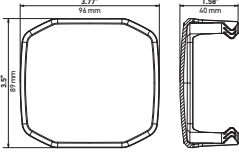
Product image / Dimensions	Light Distribution	Technical Specifications	Part Number
<p>X-TREME KIT 3" COMBO BEAM</p> 	<p>LED</p>  	<ul style="list-style-type: none"> • Voltage: 12-24 VDC • Light output (measured): 5700 lumens • Beam Pattern: Combo Beam • Power consumption: 60 Watt • Color temperature: 5700 Kelvin • Housing material: Aluminum, black stainless steel bracket • Number of LEDs: 28 • Lens material: PC • Mounting type: upright • Connection: lead wires • Approval: ECE-R10, CISPR25 Class 3 • Protection: IP67, IP69K 	<p>358233831 Combo Beam</p> <p>Content: Includes: (2) LED Headlights, (1) mounting instructions, (1) wire harness with connector, and (2) smoked stone shield covers.</p>
<p>X-TREME KIT 3" SPOT BEAM</p> 	<p>LED</p>  	<ul style="list-style-type: none"> • Voltage: 12-24 VDC • Light output (measured): 5700 lumens • Beam Pattern: Spot Beam • Power consumption: 60 Watt • Color temperature: 5700 Kelvin • Housing material: Aluminum, black stainless steel bracket • Number of LEDs: 28 • Lens material: PC • Mounting type: upright • Connection: lead wires • Approval: ECE-R10, CISPR25 Class 3 • Protection: IP67, IP69K 	<p>358233841 Spot Beam</p> <p>Content: Includes: (2) LED Headlights, (1) mounting instructions, (1) wire harness with connector, and (2) smoked stone shield covers.</p>
<p>LED CUBE KIT 3" FLOOD BEAM</p> 	<p>LED</p>  	<ul style="list-style-type: none"> • Voltage: 12-24 VDC • Light output (measured): 5700 lumens • Beam Pattern: Flood Beam • Power consumption: 60 Watt • Color temperature: 5700 Kelvin • Housing material: Aluminum, black stainless steel bracket • Number of LEDs: 28 • Lens material: PC • Mounting type: upright • Connection: lead wires • Approval: ECE-R10, CISPR25 Class 3 • Protection: IP67, IP69K 	<p>358233851 Flood Beam</p> <p>Content: Includes: (2) LED Headlights, (1) mounting instructions, (1) wire harness with connector, and (2) smoked stone shield covers.</p>
<p>LED CUBE KIT 3" SPOT BEAM AMBER</p> 	<p>LED</p>  	<ul style="list-style-type: none"> • Voltage: 12-24 VDC • Light output (measured): 5700 lumens • Beam Pattern: Spot Beam • Power consumption: 60 Watt • Color temperature: 3000 Kelvin • Housing material: Aluminum, black stainless steel bracket • Number of LEDs: 28 • Lens material: PC • Mounting type: upright • Connection: lead wires • Approval: ECE-R10, CISPR25 Class 3 • Protection: IP67, IP69K 	<p>358233941 Spot Beam</p> <p>Content: Includes: (2) LED Headlights, (1) mounting instructions, (1) wire harness with connector, and (2) smoked stone shield covers.</p>

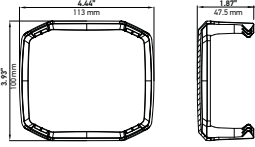

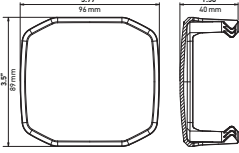
Product image / Dimensions	Light Distribution	Technical Specifications	Part Number
<p>X-TREME KIT 4" COMBO BEAM</p> 	<p>LED</p>  	<ul style="list-style-type: none"> • Voltage: 12-24 VDC • Light output (measured): 7100 lumens • Beam Pattern: Combo Beam • Power consumption: 60 Watt • Color temperature: 5700 Kelvin • Housing material: Aluminum, black stainless steel bracket • Number of LEDs: 40 • Lens material: PC • Mounting type: upright • Connection: lead wires • Approval: ECE-R10, CISPR25 Class 3 • Protection: IP67, IP69K 	<p>358233801 Combo Beam</p> <p>Content: Includes: (2) LED Headlights, (1) mounting instructions, (1) wire harness with connector, and (2) smoked stone shield covers.</p>
<p>X-TREME KIT 4" SPOT BEAM</p> 	<p>LED</p>  	<ul style="list-style-type: none"> • Voltage: 12-24 VDC • Light output (measured): 7100 lumens • Beam Pattern: Spot Beam • Power consumption: 60 Watt • Color temperature: 5700 Kelvin • Housing material: Aluminum, black stainless steel bracket • Number of LEDs: 40 • Lens material: PC • Mounting type: upright • Connection: lead wires • Approval: ECE-R10, CISPR25 Class 3 • Protection: IP67, IP69K 	<p>358233811 Spot Beam</p> <p>Content: Includes: (2) LED Headlights, (1) mounting instructions, (1) wire harness with connector, and (2) smoked stone shield covers.</p>
<p>LED CUBE KIT 4" FLOOD BEAM</p> 	<p>LED</p>  	<ul style="list-style-type: none"> • Voltage: 12-24 VDC • Light output (measured): 7100 lumens • Beam Pattern: Flood Beam • Power consumption: 60 Watt • Color temperature: 5700 Kelvin • Housing material: Aluminum, black stainless steel bracket • Number of LEDs: 40 • Lens material: PC • Mounting type: upright • Connection: lead wires • Approval: ECE-R10, CISPR25 Class 3 • Protection: IP67, IP69K 	<p>358233821 Flood Beam</p> <p>Content: Includes: (2) LED Headlights, (1) mounting instructions, (1) wire harness with connector, and (2) smoked stone shield covers.</p>
<p>LED CUBE KIT 4" SPOT BEAM AMBER</p> 	<p>LED</p>  	<ul style="list-style-type: none"> • Voltage: 12-24 VDC • Light output (measured): 7100 lumens • Beam Pattern: Spot Beam • Power consumption: 60 Watt • Color temperature: 3000 Kelvin • Housing material: Aluminum, black stainless steel bracket • Number of LEDs: 40 • Lens material: PC • Mounting type: upright • Connection: lead wires • Approval: ECE-R10, CISPR25 Class 3 • Protection: IP67, IP69K 	<p>358233921 Spot Beam</p> <p>Content: Includes: (2) LED Headlights, (1) mounting instructions, (1) wire harness with connector, and (2) smoked stone shield covers.</p>

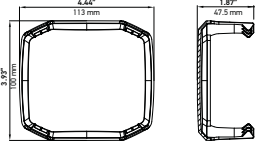
Product image / Dimensions	Light Distribution	Technical Specifications	Part Number
<p>X-TREME 3" SMOKED COVER</p> 	<p style="writing-mode: vertical-rl; transform: rotate(180deg);">LED</p> 	<ul style="list-style-type: none"> • Lens material: PC • Smoked design for 3.6 HELLA X-Treme Cubes 	<p>358233981</p> <p>Content: Includes: (1) Stone shield cover</p>
<p>X-TREME 4" SMOKED COVER</p> 	<p style="writing-mode: vertical-rl; transform: rotate(180deg);">LED</p> 	<ul style="list-style-type: none"> • Lens material: PC • Smoked design for 3.6 HELLA X-Treme Cubes 	<p>358233971</p> <p>Content: Includes: (1) Stone shield cover</p>
<p>X-TREME 3" AMBER COVER</p> 	<p style="writing-mode: vertical-rl; transform: rotate(180deg);">LED</p> 	<ul style="list-style-type: none"> • Lens material: PC • Amber design for 3.6 HELLA X-Treme Cubes 	<p>358233961</p> <p>Content: Includes: (1) Stone shield cover</p>
<p>X-TREME 4" AMBER COVER</p> 	<p style="writing-mode: vertical-rl; transform: rotate(180deg);">LED</p> 	<ul style="list-style-type: none"> • Lens material: PC • Amber design for 3.6 HELLA X-Treme Cubes 	<p>358233951</p> <p>Content: Includes: (1) Stone shield cover</p>

HELLA BLADE HP



Vehicle low-beam light



HELLA Blade in action!



FOR KINGS OF THE ROAD

The all-new HELLA Blade 6" HP driving lamp leaves absolutely nothing in the dark so that you can confidently start your next off-road adventure. The 6" Blade HP illuminates an incredible 8,500 lumens with six high-output LED modules. Its first-to-market innovative position light design can be shown in white or amber, and the contour stone shield emanates the translucent HELLA logo while the position light remains visible.

DRIVING LIGHT + POSITION LIGHT FUNCTION



DRIVING LIGHT



POSITION LIGHT



DRIVING LIGHT



POSITION LIGHT

PRODUCT VIDEO



<https://www.youtube.com/watch?v=mKX7WQewcSc>

INSTALLATION VIDEO









<https://www.youtube.com/watch?v=VKF49-JCE8w>

HELLA BLADE HP

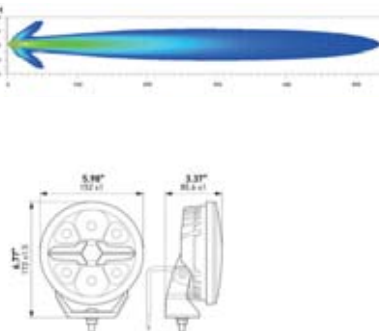
- Innovative LED position light in white or amber
- Optional white or amber position light
- For individual, attention-grabbing vehicle styling (off-road use)
- Compact design with shallow mounting depth
- Remarkable 8,500 lumen output

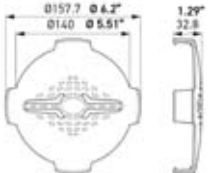

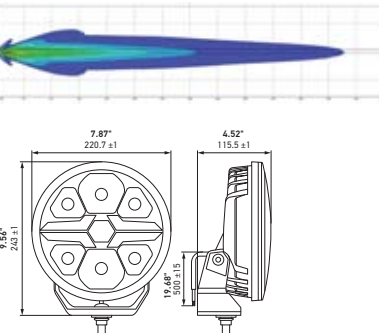
NEW!

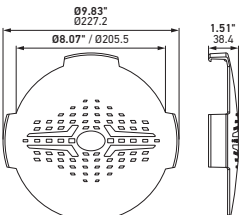
Product image / Dimensions	Light Distribution	Technical Specifications	Part Number
<p>HELLA BLADE HP 6 INCHES</p> 	<p>LED</p> 	<ul style="list-style-type: none"> • Voltage: 12-24 VDC • Light output (measured): 8500 lumens • Beam Pattern: Driving Beam • Power consumption: 90 Watt • Color temperature: 6000 Kelvin • Housing material: Aluminum, black stainless steel bracket • Number of LEDs: 6 High intensity modules • Lens material: PC • Mounting type: upright • Connection: lead wires • Approval: ECE-R10, CISPR25 Class 3 • Protection: IP67, IP69K 	<p>358228801 Driving Beam</p> <p>Content: Includes: (2) LED Headlights, (1) mounting instructions, and (2) black stone shield covers.</p>
<p>HELLA BLADE HP 6 INCHES COVER</p> 	<p>LED</p> 	<ul style="list-style-type: none"> • Lens material: PC • Black design 	<p>358233841</p> <p>Content: (1) Black stone shield cover</p>
<p>HELLA BLADE HP 9 INCHES</p> 	<p>LED</p> 	<ul style="list-style-type: none"> • Voltage: 12-30 VDC • Light output (measured): 13,200 lumens • Beam Pattern: Driving Beam • Power consumption: 120 Watts / 5W PO • Color temperature: 6000 Kelvin • Housing material: Aluminum, black stainless steel bracket • Number of LEDs: 6 LED High intensity modules • Lens material: PC • Mounting type: upright • Connection: lead wires • Approval: ECE-R10, CISPR25 Class 3 Reach, RoHS, CE, CP65 • Protection: IP67, IP69K 	<p>358228811 Driving Beam</p> <p>Content: Includes: (2) LED Headlights, (1) mounting instructions, and (2) black stone shield covers.</p>
<p>HELLA BLADE HP 9 INCHES COVER</p> 	<p>LED</p> 	<ul style="list-style-type: none"> • Lens material: PC • Black design 	<p>358198011</p> <p>Content: (1) Black stone shield cover</p>



LED LIGHT BAR 470 PO

THE AUXILIARY HEADLAMP FOR LONG-DISTANCE VISION WITH THE STRIKING DOUBLE SIGNATURE OF THE POSITION LIGHT.

Whether you are offroad or driving on asphalt surfaces, the LED Light Bar 470 PO opens up new perspectives for you. Developed for the special requirements of offroad vehicles and for aerodynamic installation on truck cab roofs, this high beam headlamp with its position light's striking double-light signature epitomises compact performance in a stylishly confident way. The adventure can begin. Prove that you, too, have got style – and go for the LED light bar with the unique position light.

- Multivoltage: 9 - 33 VDC
- Compact high beam LED headlamp
- For off-road use, submersible (fording ability up to a water depth of 1 m for up to 2 hours), IP X9K and IP 6K7
- Effective dissipation of heat created by the LED electronics thanks to the thermo-conductive plastic housing
- Power consumption at 12 V: position light 6 W and high beam 36 W
- Power consumption at 24 V: position light 6 W and high beam 36 W
- ECE approved
- Weight 900g

LED LIGHT BAR 470 PO

Content:

- Individual headlamp with 2,500 mm, 3-pin connecting cable (with open ends)
- Including bracket set
- Integral LED light sources

Description	Part Number:
LED high beam headlamp	958140001



Driving Beam



RALLYE 4000 LED METAL

THE NEW AUXILIARY HEADLAMP WITH AN UNMISTAKABLE DESIGN.

- Auxiliary driving lamp with futuristic look boasting state-of-the-art LED technology
- The striking night design is created by the LED position light with its characteristic hexagonal contoured design
- EdgeLight technology has been applied for a more intensive appearance of the position light
- The horizontal cooling fin in the auxiliary headlamp with a cooling surface of 230 cm² brings about efficient thermal management
- Replaceable LED headlamp insert with shock-resistant and fixing bracket of zinc die casting

- Voltage: 12/24 VDC
- Light output (measured): 1300 lumens (driving beam), 1220 lumens (pencil beam)
- Light beam pattern: pencil, driving
- Power consumption: @ 12V: 2.4 W + high beam @ 24 V: 5 W + high beam
- Color temperature: 6500 Kelvin
- Housing material: Aluminum
- Lens material: PC
- Mounting: zinc die-cast
- Mounting type: horizontal
- Connection: lead wires
- Approval: high beam ECE R112, ECE R7 parking light, ECE R10 EMC

Content:

- LED high-beam headlamp with LED position light
- With connecting cable
- Mounted fixing bracket
- Mounting instructions

Description	Part Number	Spare Parts	Part Number
Driving beam	016560101	Headlamp insert, Driving Beam	241430011
Pencil Beam	016560111	Headlamp insert, Pencil Beam	241449011



Driving Beam

*Can be used to upgrade Rallye 4000 halogen headlight

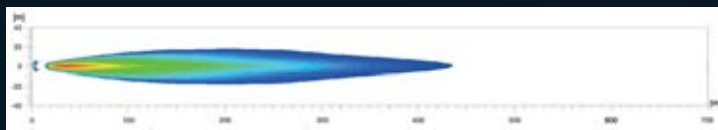

Pencil Beam

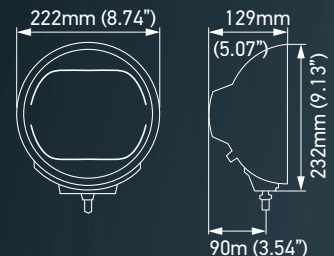
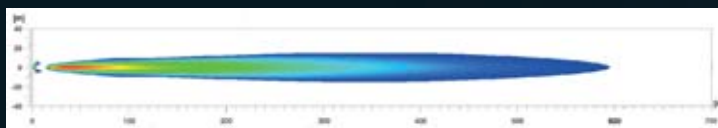

RALLYE 3003 LED

STRIKING DESIGN, POWERFUL LIGHT OUTPUT

- Auxiliary driving lamp with futuristic look boasting state-of-the-art LED technology
- The striking night design is created by the LED position light with its characteristic hexagonal contoured design
- Immediate response thanks to attention-grabbing headlight flashing
- EdgeLight technology has been applied for a more intensive appearance of the position light
- The horizontal cooling fin in the auxiliary headlamp with a cooling surface of 230 cm² brings about efficient thermal management
- Replaceable LED headlamp insert with shock-resistant PC cover lens
- Protection classes: IP X9K, IP 6K7

- Voltage: 12 VDC / 24 VDC
- Light pattern: Driving beam and Pencil Beam
- Power Consumption: 14,5 Watt + 5 Watt PO light
- Color temperature: 6500 Kelvin
- Housing material: Thermoplastic
- Lens material: PC cover lens
- Mounting Type: Vertical
- Approval: ECE

Content:

- 1 LED headlamp with LED position light
- With connecting cable
- Mounting instructions and installation components



Description Part Number:

Driving Beam	016797001
Pencil Beam	016797011

Replacement parts:

• Headlamp insert for Driving Beam	241400011
• Headlamp insert for (Pencil Beam)	241429011

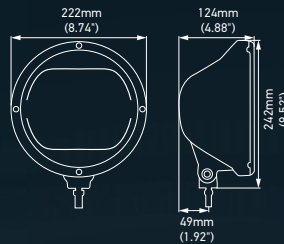

Driving Beam

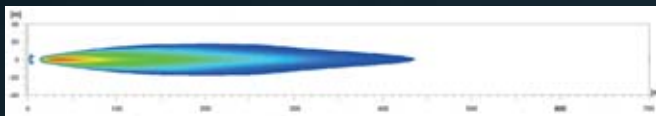

Pencil Beam



JUMBO LED

THE NEW AUXILIARY HEADLAMP WITH THE BRILLIANT, SEISMIC SMILE.

Just the name says it all: the new Jumbo LED is a full LED headlamp with a special kind of radiance – delivering luminous efficiency even more unconditionally and absolutely than its legendary predecessor. Let's see you smile – just convert now to the new Jumbo LED.

The Edge light technology intensifies the characteristic contours of the highly recognizable LED position light.

Content:

- LED high beam headlamp with LED position light
- With 3-pin connecting cable 800 mm (with open ends)
- Attachment material
- Installation instructions

- Multi-voltage: suitable for 12 V and 24 V
- Clear and bright white LED light
- Long-lasting light emission
- Impact-resistant housing made of high-quality thermoplastic material
- Immediate response for attention-grabbing headlight flashing
- Sturdy fastening bracket made of zinc-coated sheet steel with wide adjustment range
- Electronics components qualified according to automotive standard
- Particularly energy efficient and fuel saving
- Power consumption at 12 V: PO light 1.3 W and high beam 8 W
- Power consumption at 24 V: PO light 2.7 W and high beam 8 W
- ECE type-approved (ECE R149 high beam, ECE R148 position light, ECE R10 EMC)
- Weight 980g



Description	Part Number
LED headlamp, upright	016773001

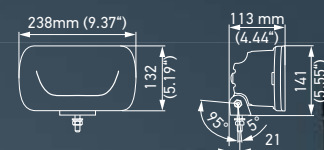
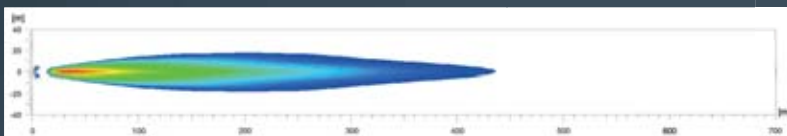



HELLA BLACK MAGIC LED

NEW PRODUCT RANGE

HELLA BLACK MAGIC LED

AUXILIARY LIGHTS

LED

CUBES	MINI LIGHT BARS	BLACK MAGIC LIGHT BARS	TOUGH SLIM LIGHT BARS	NEW!	TOUGH SLIM CURVED LIGHT BARS	NEW!
KIT WITH LAMPS*	SINGLE LAMP	SINGLE LAMP	SINGLE LAMP		SINGLE LAMP	
2.7" Flood 358176801 	6.2" Flood 358176201 	20" Slim 358176301 	20" Tough Slim 358197301 		20" Slim Curved 358197501 	
3.2" Flood 358176811 	6.2" Spot 358176211 	32" Slim 358176311 	32" Tough Slim 358197311 		32" Slim Curved 358197511 	
3.2" Spot 358176821 		40" Slim 358176321 	40" Tough Slim 358197321 		40" Slim Curved 358197521 	
		50" Slim 358176331 	50" Tough Slim 358197331 		50" Slim Curved 358197531 	
3.2" Spot / Flush 358176831 	6.2" Flush Mount, Flood 358176221 	21.5" Double 358176401 		TOUGH DOUBLE LIGHT BARS NEW! SINGLE LAMP	TOUGH DOUBLE CURVED LIGHT BARS NEW! SINGLE LAMP	
			21.5" Tough Double 358197401 		21.5" Tough Double Curved 358197601 	
ACCESSORIES						
		 Bracket set for light bar variant "Slim Row" 358176371	32" Tough Double 358197411 		32" Tough Double Curved 358197611 	
		 Bracket set for light bar variant "Double Row" 358176381	40" Tough Double 358197421 		40" Tough Double Curved 358197621 	
			50" Tough Double 358197431 		50" Tough Double Curved 358197631 	

*KIT INCLUDES: (2) LED lamps,
(1) Relay, (1) switch and mounting instructions,
(1) wire harness with DT connector

BLACK MAGIC LED SERIES

FLEXIBLE INSTALLATION

The installation kit comes complete with a lengthy cable to allow for easy vehicle mounting. The Mini Light bar, Cubes and Light bars come as a Flood or Spotlight and can be pendant mounted, upright or integrated into the body work or bumper. This light bar is ready to brighten up your big next adventure.

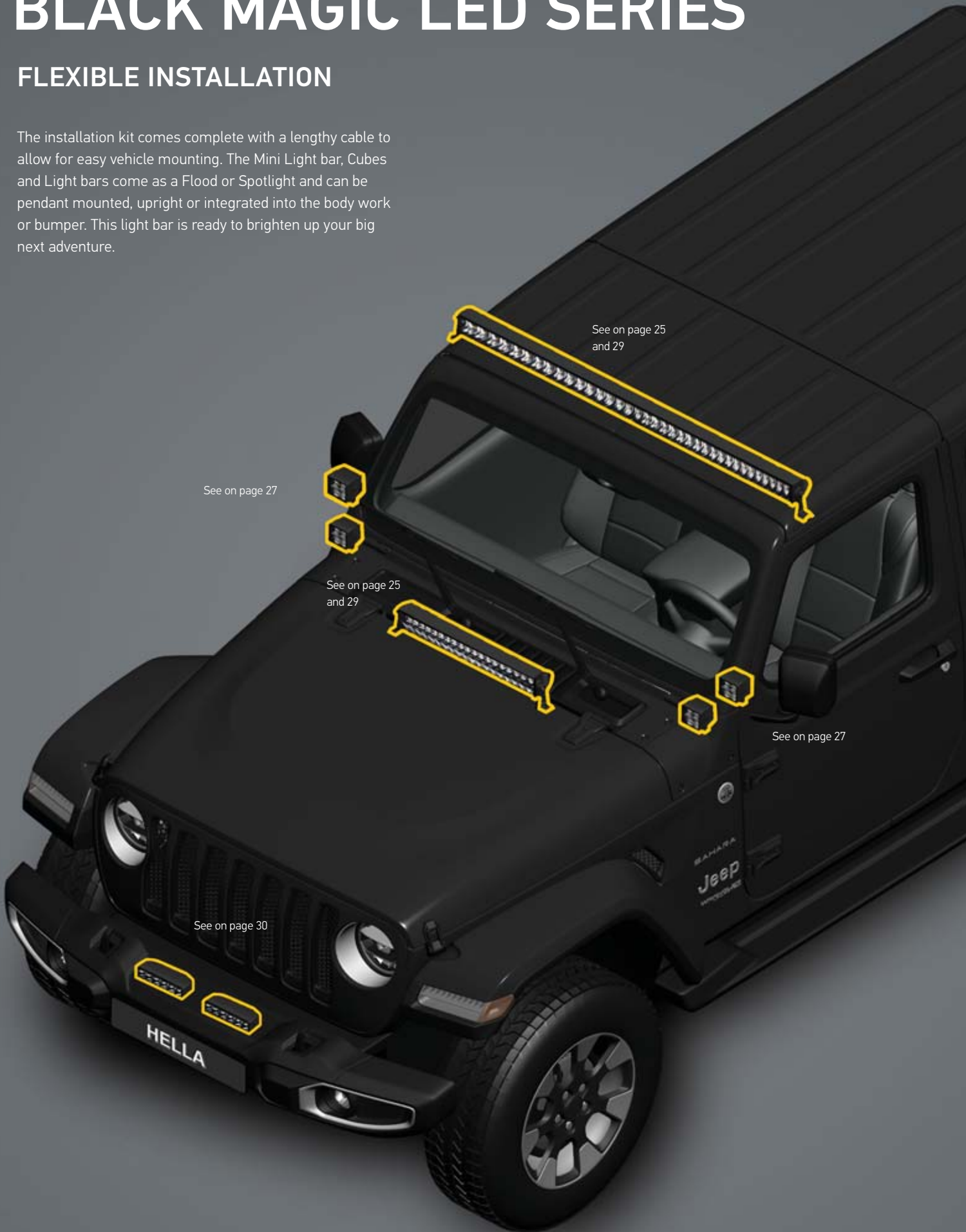

See on page 25
and 29

See on page 27

See on page 25
and 29

See on page 27

See on page 30

LED

BLACK MAGIC LED SERIES

THE NEW FULL BLACKOUT APPEARANCE

SPECIFICATIONS

- Offers some of the toughest dust / water protection on the market
- Full blackout appearance including mounting hardware
- Sleek design
- Specially developed reflector design for homogeneous illumination

For further information on each product, see general overview on page 20 - 31

BLACK MAGIC LED DISPLAY

Counter displays are the best way to promote and demonstrate the products to your customers. Mounted on a solid metal base, the display is equipped with switches and a converter to demonstrate the tremendous light performance of these new auxiliary lights. Consult with our sales representative for more information.



999942841





BLACK MAGIC TOUGH

DARK BEAUTY



Everything appears in the right light, thanks to a sophisticated reflector design and a power LED.

Beauty that comes from within and radiates outwards: the **HELLA Black Magic Light Bars** are available in 16 different variants for off-road use. With up to 80 LEDs, with up to 42,000 lumens is easily achieved. This leaves absolutely nothing in the dark – and the adventure can begin.

The light bars are available in many different lengths as "Slim" and as a "Double Row" – and for the first time both types are now also available as curved variants. All models are equipped with a temperature control system: it adjusts the light bars to the ambient temperature, protecting against overheating and also regulating the light output in cold ambient temperatures – ideal for off-road use, no matter on which continent you happen to be driving.











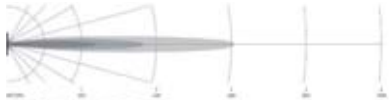

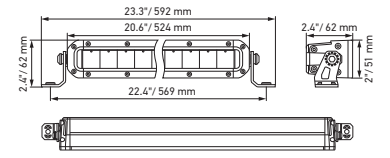

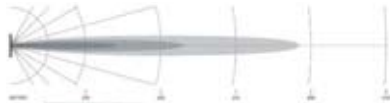

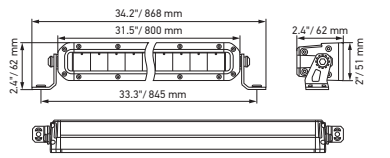
**The right light for every road or path.
Even when there is no road or path there!**

BLACK MAGIC TOUGH SLIM LIGHT BAR

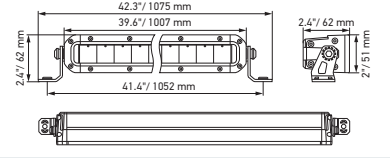
- LED High-beam slim light bar
- Full blackout appearance including black brackets
- Sleek design eliminates dust and dirt from being lodged in edges
- Temperature Control System
- Intense light output

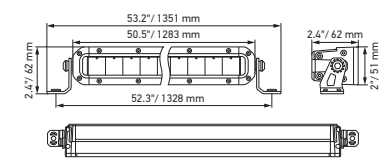

Product image / Dimensions	Light Distribution	Technical Specifications	Part Number
20" SLIM LIGHT BAR TSS 	  	<ul style="list-style-type: none"> • Voltage: 10-30 VDC • Light output (measured): 6000 lumens • Beam Pattern: Combo light (Spot and flood light) • Power consumption: 107 Watt • Current consumption: 5.68-7.73 A (12 V), 2.77-3.59 A (24 V) • Color temperature: 5700 Kelvin • Housing material: Aluminum, black stainless steel bracket • Lens material: PC • Mounting type: horizontal • Connection: 6.5 FT (2000 mm) lead wires • Approval: ECE-R10 • Protection: IP68, IP69K 	358197301 Combo light Content: (1) Light bar LED (1) assembly instructions, (1) wiring harness
32" SLIM LIGHT BAR TSS 	  	<ul style="list-style-type: none"> • Voltage: 10-30 VDC • Light output (measured): 9000 lumens • Beam Pattern: Combo light (Spot and flood light) • Power consumption: 184 Watt • Current consumption: 8.58-12.7 A (12 V), 4.22-5.78 A (24 V) • Color temperature: 5700 Kelvin • Housing material: Aluminum, black stainless steel bracket • Lens material: PC • Mounting type: horizontal • Connection: 6.5 FT (2000 mm) lead wires • Approval: ECE-R10 • Protection: IP68, IP69K 	358197311 Combo light Content: (1) Light bar LED (1) assembly instructions, (1) wiring harness
40" SLIM LIGHT BAR TSS 	  	<ul style="list-style-type: none"> • Voltage: 10-30 VDC • Light output (measured): 12000 lumens • Beam Pattern: Combo light (Spot and flood light) • Power consumption: 239 Watt • Current consumption: 10.73-16.51 A (12 V), 5.13-7.32 A (24 V) • Color temperature: 5700 Kelvin • Housing material: Aluminum, black stainless steel bracket • Lens material: PC • Mounting type: horizontal • Connection: 6.5 FT (2000 mm) lead wires • Approval: ECE-R10 • Protection: IP68, IP69K 	358197321** Combo light Content: (1) Light bar LED (1) assembly instructions, (1) wiring harness
50" SLIM LIGHT TSS 	  	<ul style="list-style-type: none"> • Voltage: 10-30 VDC • Light output (measured): 15000 lumens • Beam Pattern: Combo light (Spot and flood light) • Power consumption: 277 Watt • Current consumption: 13.63-18.46 A (12 V), 6.61-9.59 A (24 V) • Color temperature: 5700 Kelvin • Housing material: Aluminum, black stainless steel bracket • Lens material: PC • Mounting type: horizontal • Connection: 6.5 FT (2000 mm) lead wires • Approval: ECE-R10 • Protection: IP68, IP69K 	358197331** Combo light Content: (1) Light bar LED (1) assembly instructions, (1) wiring harness













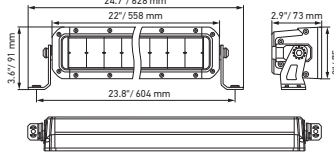

Packaging unit

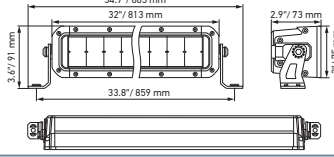
** For sturdy four-point mounting of the light bar from 40" upwards, we recommend the accessory bracket set found on page 10.

BLACK MAGIC TOUGH DOUBLE ROW LIGHT BAR

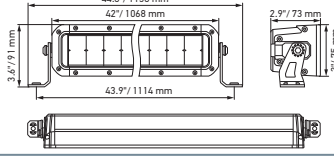
- Double row LED high-beam curved light bar
- Full blackout appearance including black brackets
- Sleek design eliminates dust and dirt from being lodged in edges
- Temperature Control System
- Intense light output

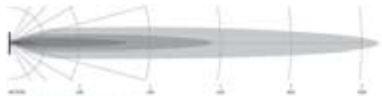

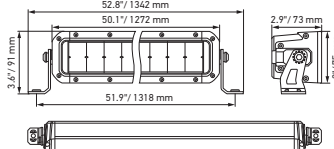
Product image / Dimensions	Light Distribution	Technical Specifications	Part Number
<p>21.5" DOUBLE ROW LIGHT BAR TSD</p> 	  	<ul style="list-style-type: none"> • Voltage: 10-30 VDC • Light output (measured): 6000 lumens • Beam Pattern: Combo light (Spot and flood light) • Power consumption: 107 Watt • Current consumption: 5.68-7.73 A (12 V), 2.77-3.59 A (24 V) • Color temperature: 5700 Kelvin • Housing material: Aluminum, black stainless steel bracket • Lens material: PC • Mounting type: horizontal • Connection: 6.5 FT (2000 mm) lead wires • Approval: ECE-R10 • Protection: IP68, IP69K 	<p>358197401 Combo light</p> <p>Content: (1) Light bar LED (1) assembly instructions, (1) wiring harness</p>
<p>30" DOUBLE ROW LIGHT BAR TSD</p> 	  	<ul style="list-style-type: none"> • Voltage: 10-30 VDC • Light output (measured): 9000 lumens • Beam Pattern: Combo light (Spot and flood light) • Power consumption: 184 Watt • Current consumption: 8.58-12.7 A (12 V), 4.22-5.78 A (24 V) • Color temperature: 5700 Kelvin • Housing material: Aluminum, black stainless steel bracket • Lens material: PC • Mounting type: horizontal • Connection: 6.5 FT (2000 mm) lead wires • Approval: ECE-R10 • Protection: IP68, IP69K 	<p>358197411 Combo light</p> <p>Content: (1) Light bar LED (1) assembly instructions, (1) wiring harness</p>
<p>40" DOUBLE ROW LIGHT BAR TSD</p> 	  	<ul style="list-style-type: none"> • Voltage: 10-30 VDC • Light output (measured): 12000 lumens • Beam Pattern: Combo light (Spot and flood light) • Power consumption: 239 Watt • Current consumption: 10.73-16.51 A (12 V), 5.13-7.32 A (24 V) • Color temperature: 5700 Kelvin • Housing material: Aluminum, black stainless steel bracket • Lens material: PC • Mounting type: horizontal • Connection: 6.5 FT (2000 mm) lead wires • Approval: ECE-R10 • Protection: IP68, IP69K 	<p>358197421** Combo light</p> <p>Content: (1) Light bar LED (1) assembly instructions, (1) wiring harness</p>
<p>50" DOUBLE ROW LIGHT BAR TSD</p> 	  	<ul style="list-style-type: none"> • Voltage: 10-30 VDC • Light output (measured): 15000 lumens • Beam Pattern: Combo light (Spot and flood light) • Power consumption: 277 Watt • Current consumption: 13.63-18.46 A (12 V), 6.61-9.59 A (24 V) • Color temperature: 5700 Kelvin • Housing material: Aluminum, black stainless steel bracket • Lens material: PC • Mounting type: horizontal • Connection: 6.5 FT (2000 mm) lead wires • Approval: ECE-R10 • Protection: IP68, IP69K 	<p>358197431** Combo light</p> <p>Content: (1) Light bar LED (1) assembly instructions, (1) wiring harness</p>

Packaging unit

** For sturdy four-point mounting of the light bar from 40" upwards, we recommend the accessory bracket set found on page 10.

BLACK MAGIC TOUGH

SLIM CURVED LIGHT BAR

- LED High-beam slim curved light bar
- Full blackout appearance including black brackets
- Sleek design eliminates dust and dirt from being lodged in edges
- Temperature Control System
- Intense light output



Product image / Dimensions	Light Distribution	Technical Specifications	Part Number
<p>20" SLIM CURVED LIGHT BAR TCS</p>	<p>LED</p>	<ul style="list-style-type: none"> • Voltage: 10-30 VDC • Light output (measured): 6000 lumens • Beam Pattern: Combo light (Spot and flood light) • Power consumption: 104 Watt • Current consumption: 5.5-7.2 (12 V), 2.78-3.53 A (24 V) • Color temperature: 5700 Kelvin • Housing material: Aluminum, black stainless steel bracket • Lens material: PC • Mounting type: horizontal • Connection: 6.5 FT (2000 mm) lead wires • Approval: ECE-R10 • Protection: IP68, IP69K 	<p>358197501 Combo light</p> <p>Content: (1) Light bar LED (1) assembly instructions, (1) wiring harness</p>
<p>32" SLIM CURVED LIGHT BAR TCS</p>	<p>LED</p>	<ul style="list-style-type: none"> • Voltage: 10-30 VDC • Light output (measured): 9000 lumens • Beam Pattern: Combo light (Spot and flood light) • Power consumption: 184 Watt • Current consumption: 8.36-12.3 A (12 V), 3.93-5.6 A (24 V) • Color temperature: 5700 Kelvin • Housing material: Aluminum, black stainless steel bracket • Lens material: PC • Mounting type: horizontal • Connection: 6.5 FT (2000 mm) lead wires • Approval: ECE-R10 • Protection: IP68, IP69K 	<p>358197511 Combo light</p> <p>Content: (1) Light bar LED (1) assembly instructions, (1) wiring harness</p>
<p>40" SLIM CURVED LIGHT BAR TCS</p>	<p>LED</p>	<ul style="list-style-type: none"> • Voltage: 10-30 VDC • Light output (measured): 12000 lumens • Beam Pattern: Combo light (Spot and flood light) • Power consumption: 222 Watt • Current consumption: 10-15.3 A (12 V), 4.75-7.22 A (24 V) • Color temperature: 5700 Kelvin • Housing material: Aluminum, black stainless steel bracket • Lens material: PC • Mounting type: horizontal • Connection: 6.5 FT (2000 mm) lead wires • Approval: ECE-R10 • Protection: IP68, IP69K 	<p>358197521** Combo light</p> <p>Content: (1) Light bar LED (1) assembly instructions, (1) wiring harness</p>
<p>50" SLIM CURVED LIGHT BAR TCS</p>	<p>LED</p>	<ul style="list-style-type: none"> • Voltage: 10-30 VDC • Light output (measured): 15000 lumens • Beam Pattern: Combo light (Spot and flood light) • Power consumption: 278 Watt • Current consumption: 115.73-18.68 A (12 V), 7.11-9.64 A (24 V) • Color temperature: 5700 Kelvin • Housing material: Aluminum, black stainless steel bracket • Lens material: PC • Mounting type: horizontal • Connection: 6.5 FT (2000 mm) lead wires • Approval: ECE-R10 • Protection: IP68, IP69K 	<p>358197531** Combo light</p> <p>Content: (1) Light bar LED (1) assembly instructions, (1) wiring harness</p>

Packaging unit







** For sturdy four-point mounting of the light bar from 40" upwards, we recommend the accessory bracket set found on page 10.

BLACK MAGIC TOUGH

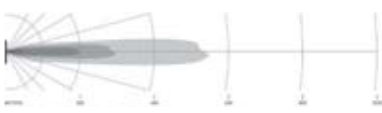
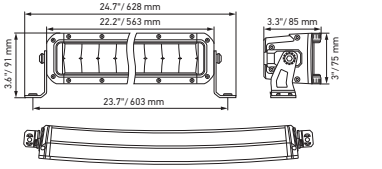
DOUBLE ROW CURVED LIGHT BAR

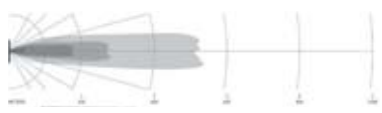
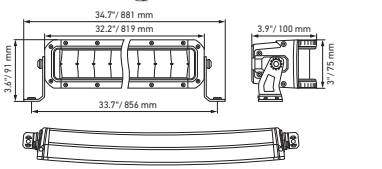
- Double row LED high-beam light bar
- Full blackout appearance including black brackets
- Sleek design eliminates dust and dirt from being lodged in edges
- Temperature Control System
- The curved version enable wider light distribution.

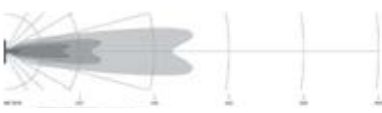
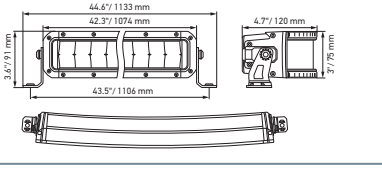

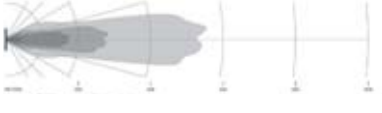
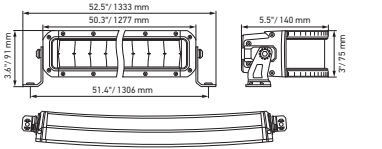

Product image / Dimensions	Light Distribution	Technical Specifications	Part Number
<p>21.5" DOUBLE ROW CURVED LIGHT BAR TCD</p> 	<p>LED</p>  	<ul style="list-style-type: none"> • Voltage: 10-30 VDC • Light output (measured): 11000 lumens • Beam Pattern: Combo light (Spot and flood light) • Power consumption: 212 Watt • Current consumption: 7.34-14.66 A (12 V), 4-7.37 A (24 V) • Color temperature: 5700 Kelvin • Housing material: Aluminum, black stainless steel bracket • Lens material: PC • Mounting type: horizontal • Connection: 6.5 FT (2000 mm) lead wires • Approval: ECE-R10 • Protection: IP68, IP69K 	<p>358197601 Combo light</p> <p>Content: (1) Light bar LED (1) assembly instructions, (1) wiring harness</p>
<p>30" DOUBLE ROW CURVED LIGHT BAR TCD</p> 	<p>LED</p>  	<ul style="list-style-type: none"> • Voltage: 10-30 VDC • Light output (measured): 13500 lumens • Beam Pattern: Combo light (Spot and flood light) • Power consumption: 310 Watt • Current consumption: 11.54-19.27 A (12 V), 5.89-10.72 A (24 V) • Color temperature: 5700 Kelvin • Housing material: Aluminum, black stainless steel bracket • Lens material: PC • Mounting type: horizontal • Connection: 6.5 FT (2000 mm) lead wires • Approval: ECE-R10 • Protection: IP68, IP69K 	<p>358197611 Combo light</p> <p>Content: (1) Light bar LED (1) assembly instructions, (1) wiring harness</p>
<p>40" DOUBLE ROW CURVED LIGHT BAR TCD</p> 	<p>LED</p>  	<ul style="list-style-type: none"> • Voltage: 10-30 VDC • Light output (measured): 16000 lumens • Beam Pattern: Combo light (Spot and flood light) • Power consumption: 426 Watt • Current consumption: 15.28-25.34 A (12 V), 8.13-14.76 A (24 V) • Color temperature: 5700 Kelvin • Housing material: Aluminum, black stainless steel bracket • Lens material: PC • Mounting type: horizontal • Connection: 6.5 FT (2000 mm) lead wires • Approval: ECE-R10 • Protection: IP68, IP69K 	<p>358197621** Combo light</p> <p>Content: (1) Light bar LED (1) assembly instructions, (1) wiring harness</p>
<p>50" DOUBLE ROW CURVED LIGHT BAR TCD</p> 	<p>LED</p>  	<ul style="list-style-type: none"> • Voltage: 10-30 VDC • Light output (measured): 19600 lumens • Beam Pattern: Combo light (Spot and flood light) • Power consumption: 503 Watt • Current consumption: 15.06-24.38 A (12 V), 7.99-17.44 A (24 V) • Color temperature: 5700 Kelvin • Housing material: Aluminum, black stainless steel bracket • Lens material: PC • Mounting type: horizontal • Connection: 6.5 FT (2000 mm) lead wires • Approval: ECE-R10 • Protection: IP68, IP69K 	<p>358197631* Combo light</p> <p>Content: (1) Light bar LED (1) assembly instructions, (1) wiring harness</p>

Packaging unit

** For sturdy four-point mounting of the light bar from 40" upwards, we recommend the accessory bracket set found on page 10.

BLACK MAGIC TOUGH ACCESSORIES

(not included in delivery)

Product Image	Description	Part Number
	<p>The bracket set for rear mounting is recommended as a mounting accessory for additional support of the LED light bars in the following lengths: 40", 50" and 52".</p> <p>The set includes two brackets and two sets of screws. The brackets are inserted into the headlamp's guide rail and securely fastened in the required position using the screws</p>	
	Bracket set for light bar variant "Slim Row"	358176371
	Bracket set for light bar variant "Double Row"	358176381









BLACK MAGIC



BLACK MAGIC LED - CUBES

- Full blackout appearance including black brackets
- Sleek design eliminates dust and dirt from being lodged in edges
- Each kit includes the wiring harness with DT connector, switch, connector and relays (easy to install)
- Compact design for universal installation



Product image / Dimensions	Light Distribution	Technical Specifications	Part Number
<p>LED CUBE KIT 2.7" FLOOD LIGHT</p> 	<p>LED</p>	<ul style="list-style-type: none"> • Voltage: 10-30 VDC • Light output (measured): 1080 lumens • Beam Pattern: Driving • Power consumption: 20 Watt • Color temperature: 5700 Kelvin • Housing material: Aluminum, black stainless steel bracket • Lens material: PC • Mounting type: horizontal • Connection: lead wires • Approval: ECE-R10 • Protection: IP68, IP69K 	<p>358176801 Driving Beam</p> <p>Content: Includes: (2) LED Headlights, (1) Relay, (1) switch and mounting instructions, (1) wire harness with DT connector</p>
<p>LED CUBE KIT 3.2" DRIVING LIGHT</p> 	<p>LED</p>	<ul style="list-style-type: none"> • Voltage: 10-30 VDC • Light output (measured): 2600 lumens • Beam Pattern: Driving • Power consumption: 40 Watt • Color temperature: 5700 Kelvin • Housing material: Aluminum, black stainless steel • Lens material: PC • Mounting type: horizontal • Connection: lead wires • Approval: ECE-R10 • Protection: IP68, IP69K 	<p>358176811 Driving Beam</p> <p>Content: Includes: (2) LED Headlights, (1) Relay, (1) switch and mounting instructions, (1) wire harness with DT connector</p>
<p>LED CUBE KIT 3.2" LONG RANGE</p> 	<p>LED</p>	<ul style="list-style-type: none"> • Voltage: 10-30 VDC • Light output (measured): 2600 lumens • Light beam pattern: Long range • Power consumption: 40 Watt • Color temperature: 5700 Kelvin • Housing material: Aluminum, steel bracket black stainless • Lens material: PC • Mounting type: horizontal • Connection: lead wires • Approval: ECE-R10 • Protection: IP68, IP69K 	<p>358176821 Long range</p> <p>Content: Includes: (2) LED Headlights, (1) Relay, (1) switch and mounting instructions, (1) wire harness with DT connector</p>
<p>LED CUBE KIT 3.2" DRIVING LIGHT FLUSH</p> 	<p>LED</p>	<ul style="list-style-type: none"> • Voltage: 10-30 VDC • Light output (measured): 2600 lumens • Beam Pattern: Driving • Power consumption: 40 Watt • Color temperature: 5700 Kelvin • Housing material: Aluminum, steel bracket black stainless • Lens material: PC • Mounting type: horizontal • Connection: lead wires • Approval: ECE-R10 • Protection: IP68, IP69K 	<p>358176831 Driving Beam</p> <p>Content: Includes: (2) LED Headlights, (1) Relay, (1) switch and mounting instructions, (1) wire harness with DT connector</p>



BLACK MAGIC LED - LIGHT BARS

- Full blackout appearance including black brackets
- Sleek design
- Temperature Control System
- Intense light output







Product image / Dimensions	Light Distribution	Technical Specifications	Part Number
LED LIGHT BAR 20" 		<ul style="list-style-type: none"> • Voltage: 10-30 VDC • Light output (measured): 6000 lumens • Beam Pattern: Driving • Power consumption: 60 Watt • Color temperature: 5700 Kelvin • Housing material: Aluminum, black stainless steel bracket • Lens material: PC • Mounting type: horizontal • Connection: lead wires • Approval: ECE-R10 • Protection: IP68, IP69K 	358176301 Long range Content: (1) Light bar LED (1) assembly instructions, (1) wiring harness
LED LIGHT BAR 32" 		<ul style="list-style-type: none"> • Voltage: 10-30 VDC • Light output (measured): 9000 lumens • Beam Pattern: Driving • Power consumption: 100 Watt • Color temperature: 5700 Kelvin • Housing material: Aluminum, black stainless steel bracket • Lens material: PC • Mounting type: horizontal • Connection: lead wires • Approval: ECE-R10 • Protection: IP68, IP69K 	358176311 Long range Content: (1) Light bar LED (1) assembly instructions, (1) wiring harness
LED LIGHT BAR 40" 		<ul style="list-style-type: none"> • Voltage: 10-30 VDC • Light output (measured): 12,000 lumens • Beam Pattern: Driving • Power consumption: 125 Watt • Color temperature: 5700 Kelvin • Housing material: Aluminum, black stainless steel bracket • Lens material: PC • Mounting type: horizontal • Connection: lead wires • Approval: ECE-R10 • Protection: IP68, IP69K 	358176321 Long range Content: (1) Light bar LED, (1) assembly instructions, (1) wiring harness
LED LIGHT BAR 50" 		<ul style="list-style-type: none"> • Voltage: 10-30 VDC • Light output (measured): 15,000 lumens • Beam Pattern: Driving • Power consumption: 160 Watt • Color temperature: 5700 Kelvin • Housing material: Aluminum, black stainless steel bracket • Lens material: PC • Mounting type: horizontal • Connection: lead wires • Approval: ECE-R10 • Protection: IP68, IP69K 	358176331 Long range Content: (1) Light bar LED (1) assembly instructions, (1) wiring harness
LED DOUBLE LIGHT BAR 21.5" 		<ul style="list-style-type: none"> • Voltage: 10-30 VDC • Light output (measured): 15,000 lumens • Beam Pattern: Driving • Power consumption: 160 Watt • Color temperature: 5700 Kelvin • Housing material: Aluminum, black stainless steel bracket • Lens material: PC • Mounting type: horizontal • Connection: lead wires • Approval: ECE-R10 • Protection: IP68, IP69K 	358176401 Long range Content: (1) Light bar LED, (1) assembly instructions, (1) wiring harness

BLACK MAGIC LED - MINI LIGHT BARS

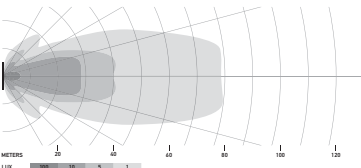
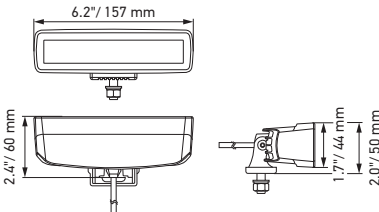
- Offers some of the toughest dust / water protection on the market
- Full blackout appearance including mounting hardware
- Sleek design

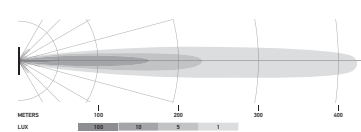
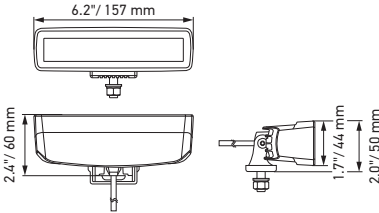

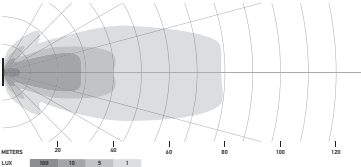
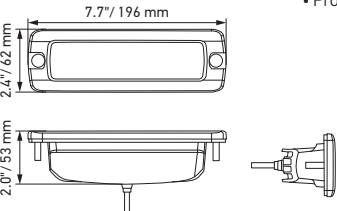
Product image / Dimensions	Light Distribution	Technical Specifications	Part Number
<p>LED MINI LIGHT BAR 6.2" SHORT RANGE</p> 	<p>LED</p>  	<ul style="list-style-type: none"> • Voltage: 10-30 VDC • Light output (measured): 1600 lumens • Beam Pattern: Driving • Power consumption: 30 Watt • Color temperature: 5700 Kelvin • Housing material: Aluminum, black stainless steel bracket • Lens material: PC • Mounting type: horizontal • Connection: lead wires • Approval: ECE-R10 • Protection: IP68, IP69K 	<p>358176201 Short range</p> <p>Content: (1) Light bar LED, (1) assembly instructions, (1) wiring harness</p>
<p>LED MINI LIGHT BAR 6.2" LONG RANGE</p> 	<p>LED</p>  	<ul style="list-style-type: none"> • Voltage: 10-30 VDC • Light output (measured): 1600 lumens • Beam Pattern: Driving • Power consumption: 30 Watt • Color temperature: 5700 Kelvin • Housing material: Aluminum, black stainless steel bracket • Lens material: PC • Mounting type: horizontal • Connection: lead wires • Approval: ECE-R10 • Protection: IP68, IP69K 	<p>358176211 Long range</p> <p>Content: (1) Light bar LED, (1) assembly instructions, (1) wiring harness</p>
<p>LED MINI LIGHT BAR 6.2" SHORT RANGE FLUSH</p> 	<p>LED</p>  	<ul style="list-style-type: none"> • Voltage: 10-30 VDC • Light output (measured): 1600 lumens • Beam Pattern: Driving • Power consumption: 30 Watt • Color temperature: 5700 Kelvin • Housing material: Aluminum, black stainless steel bracket • Lens material: PC • Mounting type: horizontal • Connection: lead wires • Approval: ECE-R10 • Protection: IP68, IP69K 	<p>358176221 Short range</p> <p>Content: (1) Light bar LED, (1) assembly instructions, (1) wiring harness</p>



HELLA LED LIGHT BAR SERIES

470 & 350 SERIES



The Choice of the Professional Driver

Then look no further: HELLA has just the right equipment for professional and recreational drivers, introducing a range of award winning LED light bars that guarantee powerful illumination for ultra-durable applications: Meet the LED Light Bar 350 and its bigger brother, the LED Light Bar 470 PO.

As a manufacturer of world leading state of the art light technology, HELLA's relentless dedication to continuously improve the latest designs is shown in the unique range of LED Light Bars that stand out due to their light weight, a revolutionary non corrosive housing and a flexible mounting system for numerous applications.



LED Light Bar 470 PO



LED Light Bar 350
SEMA Global Media
Awards Winner

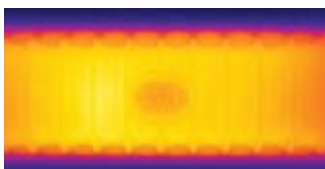

01 Outstanding Thermal Performance

Revolutionary plastic ceramic materials, with outstanding thermal performance, open up a world of possibilities that was never thought to be achievable only a few years ago. The replacement of metal based housing heat-sinks with thermally conductive plastic not only opens a myriad of design options, but also means complete corrosion resistance. This is especially important in demanding environmental conditions where lights are constantly exposed to the elements and are sometimes temporarily submerged.



A lamp housing made from thermally conductive plastic works much the same as the previously used metal housing. The innovative ceramic based plastic transfers the heat generated by the LED's and drive electronics to the outside of the lamp body, thereby lowering the internal thermal stress on the component. This in turn ensures a long service life with minimal degradation of the LED's.

02 Intelligent Design Features



Rapid heat dissipation making the lamp more thermal efficient.

Expertly designed and precision manufactured for the toughest of outdoor conditions.

The LED Light Bar housing has been purposely designed with a wavy contour to optimize rapid heat dissipation, making the lamp more thermal efficient.

Off-roading can be a dirty business, the wavy contour is easy to clean as there are no cavities which can be clogged with dirt, unlike traditional light bars with a horizontal fin design.

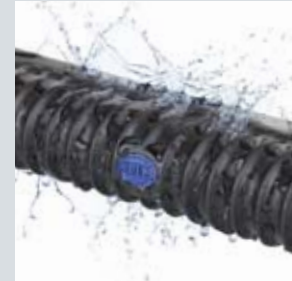

Housing design incorporates an easy to clean profile.

03 Light Weight

Less metal also means less weight: Lamps with thermally conductive plastic are up to 60% lighter than comparable metal bodied lamps. The much lower mass significantly reduces the stress on mounting points in high vibration and shock applications.

When mounting the popular Driving Lights on ATV's and off-road vehicles, weight is an important factor. Compared to many heavier lights in the market, HELLA's Light Bars have little impact on the original vehicles all-important weight distribution.

Double bracket light bar for off-road use only



04 LEDs

Durable high performance automotive grade LEDs and precision optics give the light bar superior illumination on and off-road.



LED Light Bar 350 - 12 LEDs
LED Light Bar 470 - 16 LEDs



05 Dust and Waterproof

Built to stand all weather and off-road conditions the light bar is hermetically sealed making it dust and waterproof.

IP 6K7 (Protection against dust and temporary water immersion)

IP 6K9K (Protection against dust and highpressure/ steam jet cleaning)

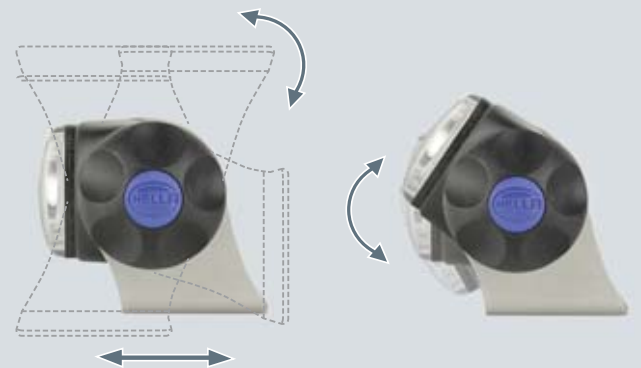

06 Low Profile Mounting System

The HELLA LED Light Bar has a much lower profile than traditional light bars, this allows more flexibility in where the lamp can be mounted. The aerodynamic design results in less disturbance to the air flow so that the vehicle's cooling and performance are not adversely affected if the lamp is mounted near a radiator grille.

The heavy duty bracket will suit most vehicle installations. Easy to mount and adjust and therefore ideal for numerous applications. Made of stainless steel, it is ultra durable and non corrosive.



HELLA LED LIGHT BAR 470 & 470 PO

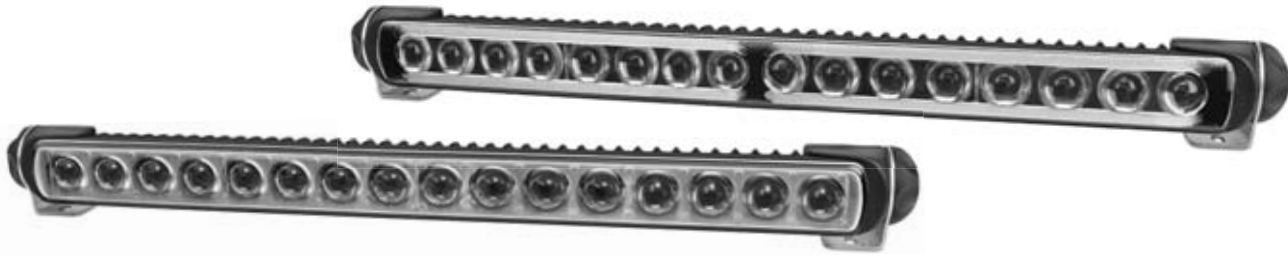

After the success of the HELLA LED Light Bar 350, HELLA is introducing the longer and brighter brother, the LED Light Bar 470. The new Light Bar features all the outstanding properties of the previous model plus an additional four high performance automotive LEDs and a maximum luminous intensity of 166,000 candela at a power consumption of only 35 watts. Weighing only 2lbs (950g) the Light Bar is particularly popular for roof mount applications on ATV's and Off-road vehicles.

The new LED Light Bar 470 PO opens up new perspectives for you. The adventure can begin. Prove that you, too, have got style – and go for the LED Light Bar with the unique position light.

Features:

- Lightweight at only 2lbs (950 g)
- 2800 measured lumens
- With 16 intensely bright high-power LEDs
- Reverse polarity and transient spike protection
- Connection: Wire leads
- 35 Watt, 9 - 33V (Multivolt)

Mounting:

- Horizontal mounting
- Pendant mounting

Applications:

- Long Range
- Off road use (Driving and Pencil beam versions ECE approved)
- Trucks / SUVs / ATVs / UTVs / Off-road vehicles

LIGHT DISTRIBUTION:

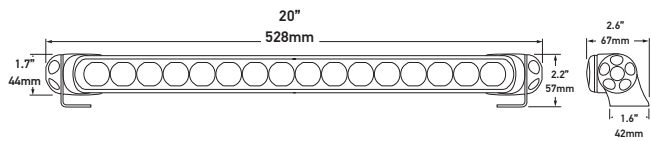
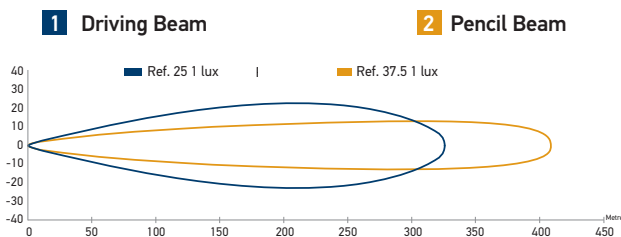

--	--	--	--	--	--	--

SPECIFICATIONS

Mounting	Upright or pendant.
Voltage	Multivolt™ for optimum brightness at input voltages from 9 to 33 volts.
Protection	Reverse polarity and transient spike protection. IP 6K7 (Protection against dust and temporary water immersion) IP 6K9K (Protection against dust and high-pressure/steam jet cleaning)
Cable Length	Pre-wired with 8ft (2.5m) of tinned multi-core cable.

CONTENTS

- 1 x LED Light Bar 470 2 x HD mounting brackets 1 x Mounting instructions



Part Number

LED light bar 470 - Driving Beam ECE approved	958130112
LED light bar 470 - Pencil Beam ECE approved	958130012
LED light bar 470 PO - Driving Beam ECE approved	958140001

Accessories

Stainless Steel Dual Bracket compatible with 350 and 470 Light Bars	Part Number
Dual Bracket	958128811

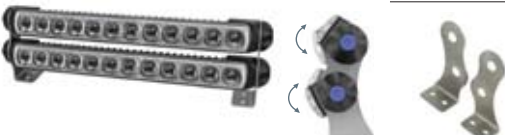

HELLA LED LIGHT BAR 350

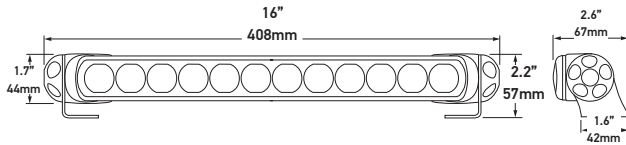

Features:

- Lightweight at only 1.7 lbs (790 g)
- Two intensity light settings for Wide and Narrow Beam versions
- 1500 Lumens for Driving and Pencil Beam versions
- 2200 Lumens for Wide and Narrow Beam versions (on 'High' setting)
- 220 Lumens for Wide and Narrow Beam versions (on 'Low' setting)
- With 12 intensely bright high-power LEDs
- Connection: Wire leads
- 25 Watt, 9 - 33V (Multivolt)

Mounting:

- Horizontal mounting
- Pendant mounting

Applications:

- Long Range
- Off road use (Driving and Pencil beam versions
ECE approved and street legal in Canada)
- Trucks / SUVs / ATVs / UTVs / Off-road vehicles

LIGHT DISTRIBUTION:

- 1** Driving Beam
- 2** Pencil Beam
- 3** Wide Beam
- 4** Narrow Beam

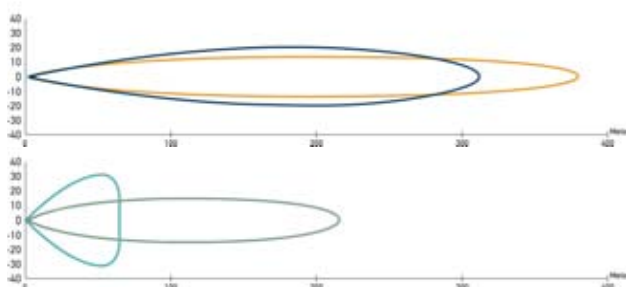

SPECIFICATIONS

Mounting	Upright or pendant.
Voltage	Multivolt™ for optimum brightness at input voltages from 9 to 33 volts.
Protection	Reverse polarity and transient spike protection. IP 6K7 (Protection against dust and temporary water immersion) IP 6K9K (Protection against dust and high-pressure/steam jet cleaning)
Cable Length	Pre-wired with 8ft (2.5m) of tinned multi-core cable.

CONTENTS

1 x LED Light Bar 350 2 x HD mounting brackets 1 x Mounting instructions

Part Number

LED light bar 350 - Driving Beam ECE approved	958040071
LED light bar 350 - Pencil Beam ECE approved	958040081
LED light bar 350 - Wide Beam with dimming function	958040521
LED light bar 350 - Narrow Beam with dimming function	958040641



Product image / Dimensions	Features	Technical Specifications	Part Number
----------------------------	----------	--------------------------	-------------

LEDAY FLEX
DAYTIME RUNNING LIGHTS

LED

- LED daytime running lights set as position light
- The set includes 2 modular chains with between 5 to 8 LED modules that can be configured in the vehicle front
- Individual LED modules are circular and have a diameter of 1.1 "(30 mm)
- Each module has a high power LED
- The metal housing safely protects the lighting and electronics against waste way and also for heat dissipation
- Connection through a 3-pole AMP system

- Voltage: 9-33 VDC
- Light pattern: DRL position light
- Power Consumption: 15 Watt per modular chain
- Color temperature: 6500 Kelvin
- Housing material: Magnesium
- Lens material: Glass
- Mounting Type: Flush
- Connection: Wire harness with AMP connector
- Approval: ECE / SAE

010458731 6 LEDs

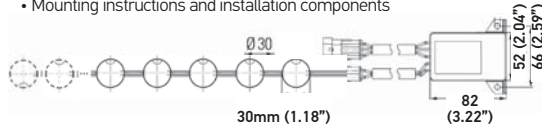

- Kit - Content:**
- 2 LED Module Strings
 - 2 control units with wire harness
 - Mounting instructions and installation components

MICRO FF LED

LED

- 6 high performance LEDs
- Free form technology
- Water and dust resistant
- Protected against reverse polarity and over heating

- Voltage: 9-33 VDC
- Light output (measured): 1500 lumens
- Light pattern: Driving beam
- Power Consumption: 22 Watt
- Color temperature: 6500 Kelvin
- Housing material: Aluminum
- Lens material: PMMA
- Mounting: Stainless steel bracket
- Mounting Type: Horizontal / Hanging
- Connection: Wire leads (200 mm) with DT connector

358115981 Single

- Content:**
- (1) LED headlight
 - Mounting instructions and installation components

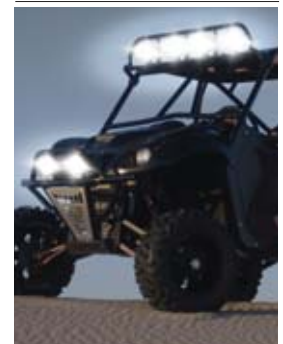
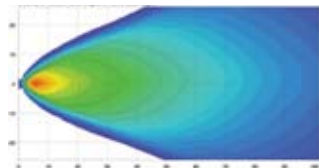
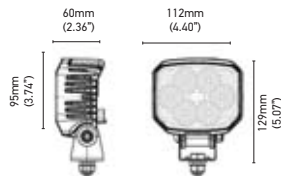

Accessories:

- Wire harness (DT): H84985241

LEDAYLINE LED
DAYTIME RUNNING LIGHTS

LED

- 5 high performance LEDs
- Attractive, transparent glass design that combines with any auxiliary headlights.
- Aluminum housing
- Compatible with SAE / DOT
- Installation without problems through various options

- Voltage: 9-33 VDC
- Light pattern: DRL position light
- Power Consumption: 6 Watt
- Color temperature: 6500 Kelvin
- Housing material: PC
- Lens material: Glass
- Mounting Type: Flush
- Connection: Wire harness with AMP connector
- Approval: ECE / SAE

010043801 Kit

- Kit - Content:**
- (2) LED headlights with brackets
 - (1) Control unit with wire harness
 - Mounting instructions and installation components

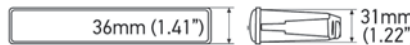
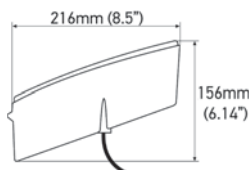

3 LED DAYTIME
RUNNING LIGHTS

LED

- 5 high performance LEDs
- Attractive, transparent glass design that combines with any auxiliary headlight.
- Installation without problems through various options

- Voltage: 9-33 VDC
- Light pattern: DRL position light
- Power Consumption: 5 Watt
- Color temperature: 6500 Kelvin
- Housing material: Aluminum
- Lens material: Glass
- Mounting Type: Vertical / Hanging
- Connection: Wire harness with AMP connector
- Approval: ECE / SAE

009496801 Kit

- Kit - Content:**
- (2) LED headlights with brackets
 - (1) Control unit with wire harness
 - Mounting instructions and installation components

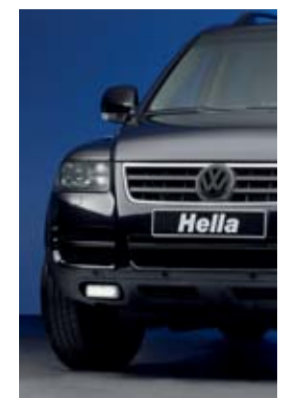
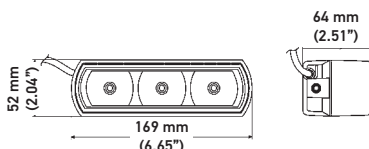

Product image / Dimensions	Features	Technical Specifications	Part Number
----------------------------	----------	--------------------------	-------------

RALLYE 4000X LED

(REF. 37.5)

LED

- 2 high performance LED modules
- Dual reflector technology calculated by computer
- High quality metal housing
- Double reflector for a light beam pattern uniform that provides a excellent road lighting
- Low energy consumption
- Water and dust resistant

Content:

- (1) LED headlight, assembly instructions

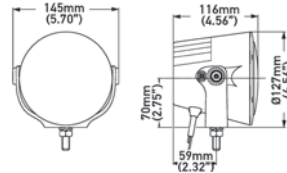

- Voltage: 10-32 VDC
- Light output (measured):: 1400 lumens
- Light pattern: Driving
- Power Consumption: 40 Watt
- Color temperature: 6000 Kelvin
- Housing material: Aluminum
- Lens material: PC
- Mounting Type: Horizontal
- Connection: 9.8 ft (3000mm) cable with open wires
- Approval: ECE

012206021

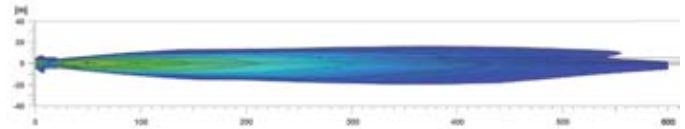

RALLYE 4000i COMPACT XENON

(REF. 37.5)

XENON

- Internal xenon reactance coil that facilitates the installation
- Compact design
- Powder paint: matte black
- Smooth lens with modern design
- Red ring

Content:

- (1) Headlight, (1) D1S xenon bulb
- Reactance coil: Integrated - Generation 4
- Cables, relay and components for installation (protective cover not included)

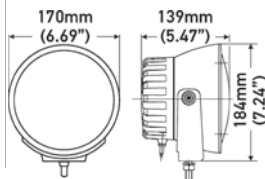

- Voltage: 12 VDC
- Light source: D1S xenon bulb
- Light pattern: Driving - Pencil beam
- Power Consumption: 35 Watt
- Housing material: Aluminum
- Lens material: Glass
- Mounting Type: Vertical / Driving
- Connection: Wire leads
- Approval: ECE - (N / A for Pencil beam)

009094331

Pencil beam

Replacement parts:

- Optical unit LA: 161825071
- Optical unit: 161825061

Accessories:

- White cover: 165048011
- Cable harness: H84994031

Pencil beam

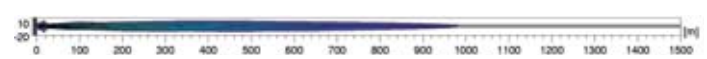

Product image / Dimensions	Features	Technical Specifications	Part Number
----------------------------	----------	--------------------------	-------------

RALLYE 4000
(REF. 37.5)

HALOGEN

- Tempered glass lens
 - Cast zinc housing with matte black finish for the most extreme driving conditions
 - Knurled buttons for quick adjustments of the light bulbs
 - Change the appearance of any headlight with our protective covers Shieldz color
- Content:**
- (1) headlight, (1) H1 12 V / 100 Watt bulb
 - (1) Protective cover, (1) Connector
 - Mounting instructions and installation components

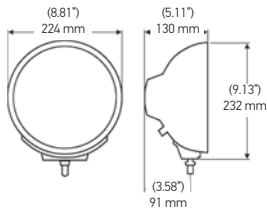

- Voltage: 12 VDC
- Light source: H1 12 V / 100 Watt / T3-1 / 4 12 V / 5W
- Light pattern: Driving - Pencil - Curve light
- Driving with position light
- Power Consumption: 100 Watt
- Housing material: Zinc,
- Lens material: Glass
- Mounting type: Vertical
- Connection: Male connector,
- Approval: ECE (-031 only)

Color Shieldz Protective Foils:
 • Clear - H87988451, Yellow - H87988351
 • Blue - H87988341, Smoked - H87988361

007560931 Driving
007560951 Pencil beam

Replacement parts:

- White cover: 147945001
- H1 12 V/100W bulb: H1 100W

Accessories:

- Clear cover: H87988131
- Protective grill: 148995001
- Harness cables: 148541001

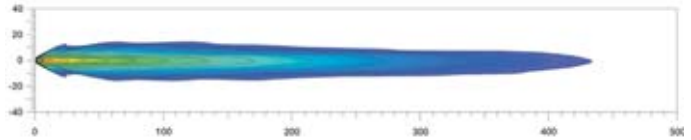

RALLYE 4000 CHROME
(REF. 37.5)

HALOGEN

- Glass lens with chromed metal housing high gloss
 - Knurled knobs for quick adjustments of the light bulb
 - Designed for driving conditions extreme
- Content:**
- (1) Headlight, (1) H1 12 V / 100W bulb + bulb for T3-1 / 4 12 V / 5W (W5W) position light
 - (1) Protective cover and Pigtail connector
 - Mounting instructions and installation components

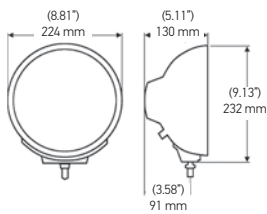

- Voltage: 12 VDC
- Light source: H1 12 V/100 Watt / T3-1 / 4 12 V/5W (W5W)
- Light pattern: Driving
- Power Consumption: 100 Watt
- Housing material: Zinc
- Lens material: Glass
- Mounting Type: Vertical
- Connection: Pigtail Connector
- Approval: ECE

007560911

Replacement parts:

- White cover: 147945001
- H1 12 V/100W bulb: H1 100W
- T3-1/4 12 V/5W (W5W)
- Reflector Unit: 148131011

Accessories:

- White cover: H87988131
- Protective grill: 148995001
- Cable harness: 149147001
- Harness 2 lamps: H84994031

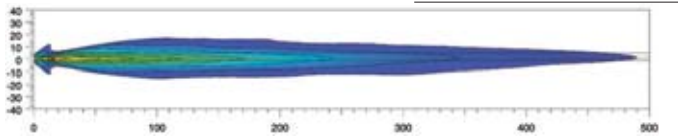

RALLYE 4000 FOG LIGHT

HALOGEN

- Tempered glass lens
 - Cast zinc housing with matte black finish
 - Knurled knobs for quick adjustments of the light bulb
 - Designed for driving conditions more extreme
- Content:**
- (1) Headlight, (1) H3 12V / 55W halogen bulb
 - (1) Protective cover and Pigtail connector
 - Mounting instructions and installation components

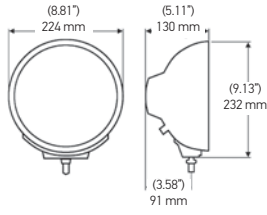

- Voltage: 12 VDC
- Light source: H3 12 V / 55W
- Light pattern: Fog
- Power Consumption: 55 Watt
- Housing material: Zinc
- Lens material: Glass
- Mounting Type: Vertical
- Connection: Pigtail Connector
- Approval: ECE / SAE

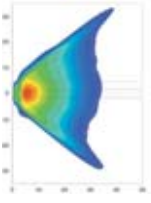

007560901

Replacement parts:

- White cover: 147945001
- H3 12 V/55W bulb: H3
- Reflector unit: 148131011

Accessories:

- Clear cover: H87988131
- Protective grill: 148995001
- Cable harness: 149147001
- Harness 2 lamps: H84994031

Color Shieldz Protective Foils:

- Clear: H87988451
- Blue: H87988351
- Smoked: H87988361

RALLYE 4000 FF
(REF. 37.5)

HALOGEN

- Free form glass lens
 - Cast zinc housing with matte black finish
 - Knurled knobs for quick adjustments of the light bulb
 - Designed for driving conditions more extreme
- Content:**
- (1) Headlight, (1) H1 Bulb 12 V / 55 Watt + bulb for T3-1 / 4 12 V / 5W (W5W) position light
 - (1) Protective cover and Pigtail connector
 - Mounting instructions and installation components

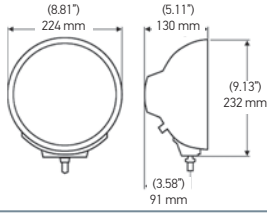

- Voltage: 12 VDC
- Light source: H1 12 V/55 Watt / T3-1/4 12 V / 5W (W5W)
- Light pattern: Driving
- Power Consumption: 55 Watt
- Housing material: Zinc
- Lens material: Glass
- Mounting Type: Vertical
- Connection: Male connector
- Approval: ECE

007560361

Replacement parts:

- White cover: 147945001
- H1 12 V/55W bulb: H1
- T3-1/4 12 V/5W (W5W)
- Reflector unit: 148131011

Accessories:

- Clear cover: H87988131
- Protective grill: 148995001
- Cable harness: 148541001

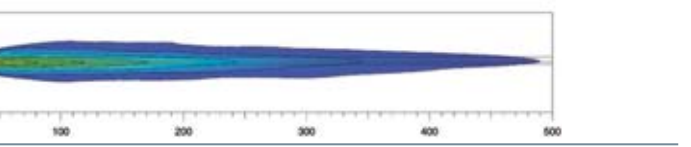

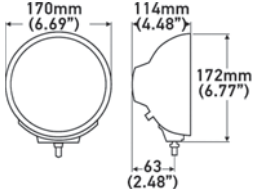
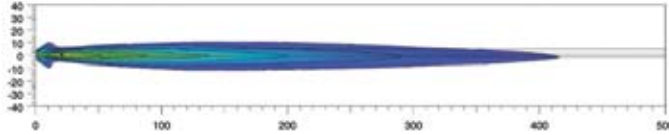
Product image / Dimensions	Features	Technical Specifications	Part Number
<p>RALLYE 4000 COMPACT (REF. 37.5)</p> 	<p>HALOGEN</p> <ul style="list-style-type: none"> Optimized free form reflector Transparent glass design 24% smaller than the Rally 4000 CELIS LED circular position light (009094191) <p>Content:</p> <ul style="list-style-type: none"> (1) Headlight, (1) H1 12 V / 55 Watt bulb (not included in -101) (1) Protective cover (not included in -101) Mounting instructions and installation components * Cable harness sold separately 	<ul style="list-style-type: none"> Voltage: 12 VDC Light source: H1 12 V / 55 Watt Light pattern: Driving - Long range Power Consumption: 55 Watt Housing material: Cast zinc housing with matte black finish Lens material: Glass Mounting Type: Vertical Connection: Wire leads Approval: ECE (-081 only) 	<p>009094181 Driving</p> <p>Replacement parts:</p> <ul style="list-style-type: none"> White cover: 165048001 H1 12 V/55W bulb: H1 <p>Accessories:</p> <ul style="list-style-type: none"> Clear cover: H87988221 Cable harness: H84994031

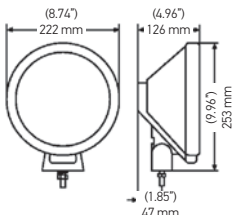
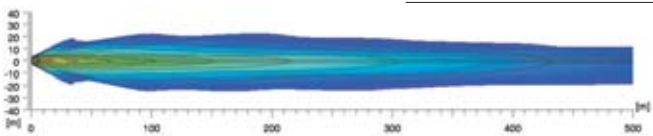
<p>RALLYE 3000 BLUE (REF. 37.5)</p> 	<p>HALOGEN</p> <ul style="list-style-type: none"> Blue glass lens - the light beam looks white when it lights Optimized free form reflector Black ABS housing with silver ring with design blue stripes <p>Content:</p> <ul style="list-style-type: none"> (1) Headlight (1) Pigtail Connector Mounting instructions and installation components 	<ul style="list-style-type: none"> Voltage: 12 VDC Light pattern: Driving Light source: H1 12 V/55 Watt - T3-1/4 12 V/5W (W5W) Power Consumption: 55 Watt Housing material: ABS (housing) Lens material: Glass Mounting: Zinc coated steel bracket Mounting Type: Vertical Connection: Pigtail Approval: ECE 	<p>006800901</p> <p>Replacement parts:</p> <ul style="list-style-type: none"> T3-1/4 12V/5W 2825 Reflector unit ECE: 157042011 Pigtail: H84994061 <p>Accessories:</p> <ul style="list-style-type: none"> Bombillo H1 12/55W H1 White cover: 142700001 Cable harness: H84994031
---	---	---	---

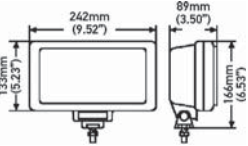
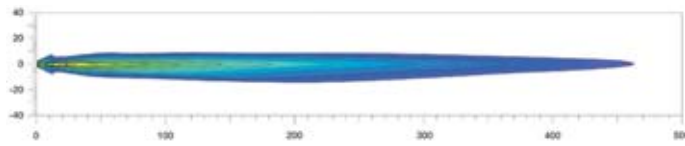
<p>JUMBO 220 (REF. 37.5)</p> 	<p>HALOGEN</p> <ul style="list-style-type: none"> Classic design Black impact resistant housing and ring retention Glass lens Traditional design, the ideal complement to trucks and SUVs <p>Content:</p> <ul style="list-style-type: none"> (1) headlight, (1) H3 12 V / 55 Watt bulb (1) protective cover Mounting instructions and installation components 	<ul style="list-style-type: none"> Voltage: 12 VDC Light source: H3 12 V / 55 Watt Light pattern: Driving Power Consumption: 55 Watt Housing material: ABS (housing) Lens material: Glass Mounting: Zinc coated steel bracket Mounting Type: Vertical / Hanging Connection: Without cables Approval: ECE / SAE 	<p>006300921 Driving</p> <p>Replacement parts:</p> <ul style="list-style-type: none"> H3 12 V/55W bulb: H3 <p>Accessories:</p> <ul style="list-style-type: none"> White cover: 138127001 Cable harness: H84994031
---	--	---	--

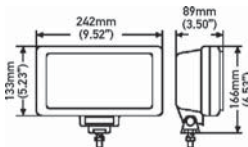
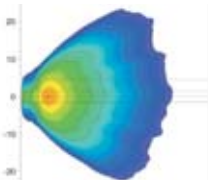
<p>JUMBO 220 FOG LIGHT</p> 	<p>HALOGEN</p> <ul style="list-style-type: none"> Classic design for fog conditions Black impact resistant housing and ring retention Glass lens Traditional design, the ideal complement to trucks and SUVs <p>Content:</p> <ul style="list-style-type: none"> (1) headlight, (1) H3 12 V / 55 Watt bulb (1) protective cover Mounting instructions and installation components 	<ul style="list-style-type: none"> Voltage: 12 VDC Light source: H3 12 V / 55 Watt Light pattern: Fog Power Consumption: 55 Watt Housing material: ABS (housing) Lens material: Glass Mounting: Zinc coated steel bracket Mounting Type: Vertical / Hanging Connection: Without cables Approval: ECE / SAE 	<p>006300911</p> <p>Replacement parts:</p> <ul style="list-style-type: none"> H3 12 V/55W bulb: H3 <p>Accessories:</p> <ul style="list-style-type: none"> White cover: 138127001 Cable harness: H84994031
---	---	---	---

HELLA 500 SERIES



The art of lighting with an innovative reflector with free form technology







The HELLA 500, 500FF 700FF halogen auxiliary lamp series can easily be installed on the roof or on the front apron of the vehicles. They are perfectly equipped to withstand extreme driving situations. That not only sounds good, it also looks good: Compact design and black housing with matte finish.

In terms of lighting technology, these auxiliary lamps offer the following features a classic 500 and 700 series lamp design: A homogeneous illumination that, with the help of the computer-optimized free-form reflector, provides excellent visibility and active safety in extreme weather and driving conditions.

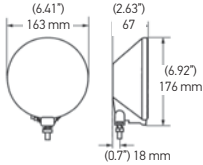
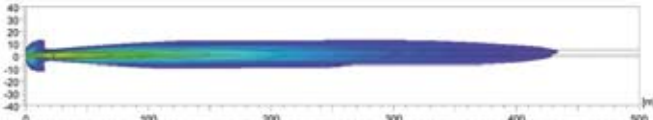
All HELLA 500, 500FF and 700FF series auxiliary lamps include:

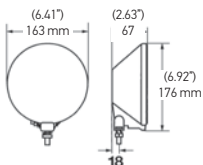
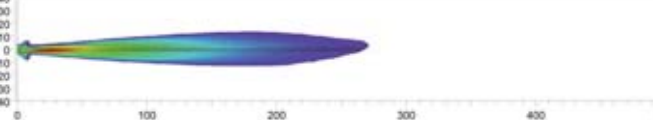
- 2 Halogen driving lights
- 2 Bulbs of 12 V / 55 Watt.
- 2 protective covers.
- 1 Relay 12 V, 1 Switch
- Wire harness, mounting brackets and assembly instructions.

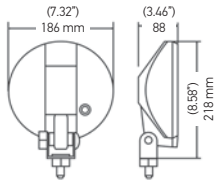
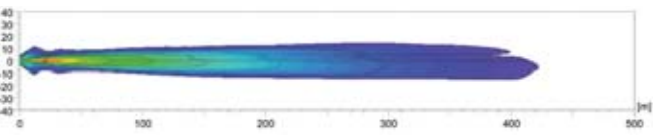

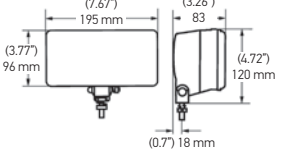
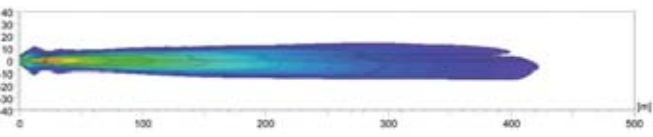
Product image / Dimensions	Features	Technical Specifications	Part Number
HELLA 500 (REF. 37.5) 	HALOGEN <ul style="list-style-type: none"> Lightweight design Impact resistant ABS housing Aluminum vapor coated reflector Glass lens Single - Content: <ul style="list-style-type: none"> (1) Headlight, (1) H3 12 V / 55 Watt bulb (1) protective cover Mounting instructions and installation components Kit - Content: <ul style="list-style-type: none"> (2) Headlights, (2) H3 12V / 55W bulbs, (1) wire harness (2) Protective covers, (1) switch, (1) relay Mounting instructions and installation material 	<ul style="list-style-type: none"> Voltage: 12 VDC Light source: H3 12 V / 55 Watt Light pattern: Driving Power Consumption: 55 Watt Housing material: ABS (housing) Lens material: Glass Mounting: Zinc coated steel braket Mounting Type: Vertical / Hanging Connection: Wire leads Approval: ECE <ul style="list-style-type: none"> Change the appearance of any headlight in the series HELLA 500 with Shield protective films available in: yellow, smoky and blue tones 	005750952 Kit 005750512 Single - amber Replacement parts: <ul style="list-style-type: none"> H3 12/55W bulb: H3 Relay 12 V/15A: 003530001 LED switch (green): H61923001 Accessories: <ul style="list-style-type: none"> Clear cover: H87988081 Protective grill: 165530801 Cable harness: H84994031
HELLA 500 BLACK MAGIC 	HALOGEN <ul style="list-style-type: none"> Lightweight design Impact resistant ABS housing Aluminum vapor coated reflector The innovative black optics technology creates a only appearance when off. Glass lens Kit - Content: <ul style="list-style-type: none"> (2) Headlights, (2) H3 12V / 55W bulbs, (1) wire harness (2) Protective covers, (1) switch, (1) relay Mounting instructions and installation material 	<ul style="list-style-type: none"> Voltage: 12 VDC Light source: H3 12 V / 55 Watt Light pattern: Driving Power Consumption: 55 Watt Housing material: ABS (housing) Lens material: Glass Mounting: Zinc coated steel with black finish braket Mounting Type: Vertical Connection: Wire leads Approval: SAE 	005750991 Kit Replacement parts: <ul style="list-style-type: none"> H3 12/55W bulb: H3 Relay 12 V/15A: 003530001 LED switch (green): H61923001 Accessories: <ul style="list-style-type: none"> Black cover: H73146011 Clear cover: H87988081 Protective grill: 165530801 Cable harness: H84994031
HELLA 700FF (REF. 37.5) 	HALOGEN <ul style="list-style-type: none"> Lightweight design Impact resistant ABS housing Aluminum vapor coated reflector with free form technology with glass lens Single - Content: <ul style="list-style-type: none"> (1) headlight, (1) bulb H3 12 V / 55 Watt (1) protective cover Mounting instructions and installation components Kit - Content: <ul style="list-style-type: none"> (2) Headlights, (2) H3 12V / 55W bulbs, (1) wire harness (2) Protective covers, (1) switch, (1) relay Mounting instructions and installation material 	<ul style="list-style-type: none"> Voltage: 12 VDC Light source: H3 12 V / 55 Watt Light pattern: Driving Power Consumption: 55 Watt Housing material: ABS (housing) Lens material: Glass Mounting: Zinc coated steel bracket Mounting Type: Vertical Connection: Wire leads Approval: ECE 	010032001 Single Replacement parts: <ul style="list-style-type: none"> H3 12/55W bulb: H3 Relay 12 V/15A: H84994031 LED switch (green): H61923001 Accessories: <ul style="list-style-type: none"> White cover: 173147001 Cable harness: H84994031
HELLA 550 (REF. 17.5) 	HALOGEN <ul style="list-style-type: none"> Lightweight design Impact resistant ABS housing Aluminum vapor coated reflector and glass lens Single - Content: <ul style="list-style-type: none"> (1) headlight, 1 bulb H3 12 V / 55 Watt (1) Protective cover and Mounting instructions Kit - Content: <ul style="list-style-type: none"> (2) Headlights, (2) H2 12 V / 55 Watt bulbs, (1) wire harness (2) Protective covers, (1) switch, (1) relay Mounting instructions and installation components 	<ul style="list-style-type: none"> Voltage: 12 VDC Light source: H3 12 V / 55 Watt Light pattern: Driving Power Consumption: 55 Watt Housing material: ABS (housing) Lens material: Glass Mounting: Zinc coated steel bracket Mounting Type: Vertical / Hanging Connection: Without cables Approval: ECE / SAE 	005700471 Single Replacement parts: <ul style="list-style-type: none"> H3 12/55W bulb: H3 LED switch (green): H61923001 Accessories: <ul style="list-style-type: none"> White cover: H87037001 Clear cover: H87988111 Cable harness: H84994031

Product image / Dimensions	Features	Technical Specifications	Part Number
----------------------------	----------	--------------------------	-------------

HELLA 550
FOG LIGHT

HALOGEN



- Lightweight design
 - Impact resistant ABS housing
 - Aluminum vapor coated reflector
 - Glass lens
- Single - Content:**
- (1) Headlight, 1 H3 12 V / 55 Watt bulb
 - (1) Protective cover and Mounting instructions
- Kit - Content:**
- (2) Headlights, (2) H2 12 V / 55 Watt bulbs, (1) wire harness
 - (2) Protective covers, (1) switch, (1) relay
 - Mounting instructions and installation components

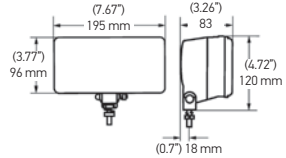

- Voltage: 12 VDC
- Light source: H3 12 V / 55 Watt
- Light pattern: Fog
- Power Consumption: 55 Watt
- Housing material: ABS (housing)
- Lens material: Glass
- Mounting: Zinc coated steel bracket
- Weight: 1200 g
- Mounting Type: Vertical / Hanging
- Connection: Without cables
- Approval: ECE / SAE

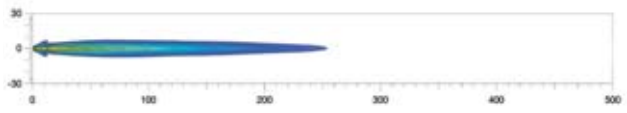

005700441 Single

- Replacement parts:**
- H3 12/55W bulb: H3
 - LED switch (green): H61923001

- Accessories:**
- White cover: H87037001
 - Clear cover: H87988111
 - Cable harness: H84994031

HELLA 550
FOG LIGHT / AMBER

HALOGEN



- Lightweight design
 - Impact resistant ABS housing
 - Aluminum vapor coated reflector
 - Classic design
- Single - Content:**
- (1) headlight, (1) H3 12 V / 55W bulb
 - (1) Protective cover and Mounting instructions
- Kit - Content:**
- (2) Headlights, (2) H3 12V / 55W bulbs, (1) wire harness
 - (2) Protective covers, (1) switch, (1) relay
 - Mounting instructions and installation components

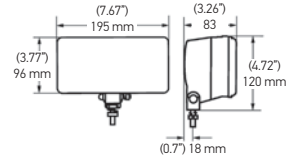

- Voltage: 12 VDC
- Light source: H3 12 V / 55W
- Light pattern: Fog
- Power Consumption: 55 Watt
- Housing material: ABS (housing)
- Lens material: Glass
- Mounting: Zinc coated steel bracket
- Mounting Type: Vertical / Hanging
- Connection: Without cables
- Approval: ECE / SAE

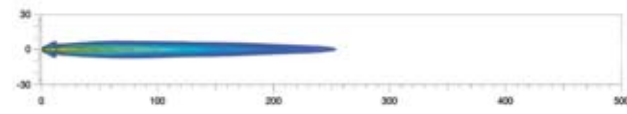

005700421 Single

- Replacement parts:**
- H3 12/55W bulb: H3
 - LED switch (green): H61923001

- Accessories:**
- White cover: H87037001
 - Clear cover: H87988111
 - Cable harness: H84994031

HELLA 450

HALOGEN



Driving lamp



Fog lamp

- Impact resistant ABS housing
 - Aluminum vapor coated reflector
 - Classic design
- Single - Content:**
- (1) headlight, (1) bulb H3 12 V / 55W
 - (1) Protective cover and Mounting instructions
- Kit - Content:**
- (2) Headlights, (2) H3 12V / 55W bulbs, (1) wire harness
 - (2) Protective covers, (1) switch, (1) relay
 - Mounting instructions and installation material

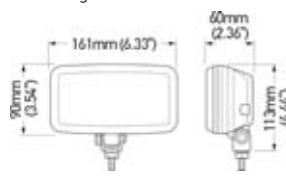

- Voltage: 12 VDC
- Light source: H3 12 V / 55 Watt
- Light pattern: Driving (...231) and Fog light(...210)
- Power Consumption: 55 Watt
- Housing material: ABS (housing)
- Lens material: Glass
- Mounting: Zinc coated steel bracket
- Mounting Type: Vertical / Hanging
- Connection: Wire leads
- Approval: ECE / SAE

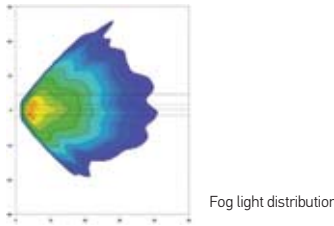

005860231 Single

005860201 Fog light - Single

005860601 Fog light - Kit

- Replacement parts:**
- H3 12/55W bulbs: H3
 - Reflector unit (Fog): 137001021

- Accessories:**
- Clear cover: H87988071
 - Cable harness: H84994031

HELLA 450
FOG LIGHT - AMBER

HALOGEN



- Lightweight design
 - Impact resistant ABS housing
 - Aluminum vapor coated reflector
 - Glass lens
- Single - Content:**
- (1) Headlight
 - (1) H3 12 V / 55W bulb
 - (1) Protective cover
 - Mounting instructions and installation components

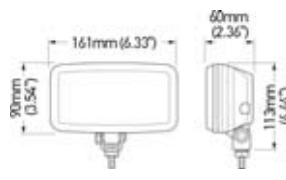



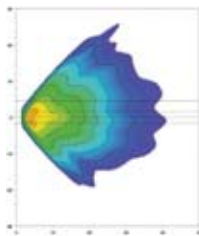





- Voltage: 12 VDC
- Light source: H3 12 V / 55 Watt
- Light pattern: Fog
- Power Consumption: 55 Watt
- Housing material: ABS (housing)
- Lens material: Glass
- Mounting: Stainless steel bracket
- Mounting Type: Vertical / Hanging
- Connection: Wire leads
- Approval: ECE



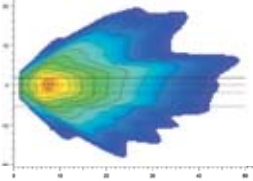

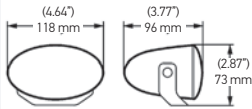
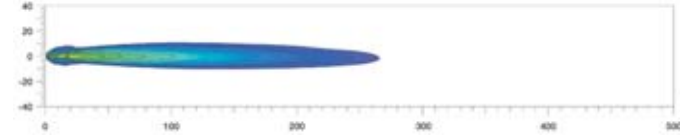













005860221 Single

- Replacement parts:**
- H3 12/55W bulb: H3

- Accessories:**
- Clear cover: H87988071
 - Cable harness: H84994031

Product image / Dimensions	Features	Technical Specifications	Part Number
<p>FF 75 FOG LIGHT</p> 	<p style="writing-mode: vertical-rl; transform: rotate(180deg);">HALOGEN</p> <ul style="list-style-type: none"> • Compact, long and flat design - convenient for tight spaces • Transparent glass lens • Free form magnesium reflector for output optimal light • Magnesium offers a high thermal resistance that prevents deformation <p>Single - contains:</p> <ul style="list-style-type: none"> • (1) lamp, (1) H7 12 V / 55 Watt bulb • Mounting instructions and installation components <p>Kit - contains:</p> <ul style="list-style-type: none"> • (2) lamps, (2) H7 12 V / 55 Watt bulbs • (1) wire harness, (1) relay, (1) switch • Mounting instructions and installation components  	<ul style="list-style-type: none"> • Voltage: 12 VDC • Light source: H7 12 V / 55 Watt • Light pattern: Fog • Power Consumption: 55 Watt • Housing material: PVC • Lens material: Glass • Mounting: Stainless steel bracket • Mounting Type: Vertical / Hanging • Connection: Bulb connector • Approval: ECE / SAE 	<p>008284001 Single</p> <p>008284801 Kit</p> <p>Replacement parts:</p> <ul style="list-style-type: none"> • H7 12/55W bulb: H7 <p>Accessories:</p> <ul style="list-style-type: none"> • White cover: H87236051 • Clear cover: H87988011 • Cable harness: H84994031
<p>FF 50 (REF. 12.5)</p> 	<p style="writing-mode: vertical-rl; transform: rotate(180deg);">HALOGEN</p> <ul style="list-style-type: none"> • Compact, long and flat design - convenient for tight spaces • Transparent glass lens / blue glass lens • Free form magnesium reflector for output optimal light • Magnesium offers a high thermal resistance that prevents deformation <p>Single - contains:</p> <ul style="list-style-type: none"> • (1) lamp, (1) H7 12 V / 55W bulb • Mounting instructions and installation components <p>Kit - contains:</p> <ul style="list-style-type: none"> • (2) lamps, (2) H7 12 V / 55W bulbs • (1) wire harness, (1) relay, (1) switch • Mounting instructions and installation components  	<ul style="list-style-type: none"> • Voltage: 12 VDC • Light source: H7 12 V / 55 Watt • Light pattern: Driving • Power Consumption: 55 Watt • Housing material: PVC • Lens material: Glass • Mounting: Stainless steel bracket • Mounting Type: Vertical / Hanging • Connection: Bulb connector • Approval: ECE / SAE 	<p>008283011 Single</p> <p>008283811 Kit</p> <p>Replacement parts:</p> <ul style="list-style-type: none"> • H7 12/55W bulb: H7 <p>Accessories:</p> <ul style="list-style-type: none"> • Clear cover: H87988001 • Cable harness: H84994031
<p>GRILLE COVER 500 SERIES</p> 	<ul style="list-style-type: none"> • 6.4" Round Black Plastic Light Grilles with White Logo for 500, 500FF-Series • Set of two grille covers 		<p>165530801</p>
<p>STONE SHIELD 500 SERIES</p> 	<ul style="list-style-type: none"> • Cover for 500 Series • Clear cover • Single stone shield 		<p>905441001</p>
<p>STONE SHIELD 4000 SERIES</p> 	<ul style="list-style-type: none"> • Cover for 4000 Series • Clear cover • Single stone shield 		<p>905445001</p>

Product image / Dimensions	Features	Technical Specifications	Part Number
GRILLE COVER 4000 SERIES 	<ul style="list-style-type: none"> • Round Black plastic light grilles with white logo for 4000 Series • Set of two grille covers 		148995001
STONE SHIELD 4000 CPT CLEAR 	<ul style="list-style-type: none"> • Cover for 4000 Series • Clear cover • Single stone shield 		165530801
STONE SHIELD 1000 BLACK MAGIC 	<ul style="list-style-type: none"> • Cover for Black Magic 1000 Series • Clear cover • Single stone shield 		905438001
STONE SHIELD 450 SERIES 	<ul style="list-style-type: none"> • Cover for 450 Series • Clear cover • Single stone shield 		905440001
STONE SHIELD FF75 SERIES 	<ul style="list-style-type: none"> • Cover for FF75 Series • Clear cover • Single stone shield 		905452001
STONE SHIELD 550 SERIES 	<ul style="list-style-type: none"> • Cover for 550 Series • Clear cover • Single stone shield 		905442001
STONE SHIELD FF50 SERIES 	<ul style="list-style-type: none"> • Cover for FF50 Series • Clear cover • Single stone shield 		905451001
RUBBER BOOT 90MM FOG 	<ul style="list-style-type: none"> • Cover rubber for 90 mm fog (008 582-...) • Black cap • Single 		158051007

Product image / Dimensions	Features	Technical Specifications	Part Number
RUBBER BOOT 90MM FOG 	<ul style="list-style-type: none"> • Rubber boot for Micro DE and DE Fog • Black cap • Single 		<u>147009007</u>
STONE SHIELD HELLA BLADE 6" 	<ul style="list-style-type: none"> • Lens material: PC • Black design 		<u>358198031</u>
STONE SHIELD 500 / 500FF / BM 	<ul style="list-style-type: none"> • Lens material: PC • Black design 		<u>173146011</u>
STONE SHIELD 500 LED 	<ul style="list-style-type: none"> • Lens material: PC • Amber design 		<u>358116991</u>
STONE SHIELD COMET 500 LED 	<ul style="list-style-type: none"> • Stone Shield, Black on White Plastic • Classic design 		<u>135037901</u>
STONE SHIELD RALLYE 4000 SERIES 	<ul style="list-style-type: none"> • Stone Shield - Rallye 4000 Series • Classic design 		<u>147945001</u>
STONE SHIELD 500 / 500FF 	<ul style="list-style-type: none"> • Stone Shield fro 500 / 500FF • Classic design 		<u>173146001</u>
STONE SHIELD 1000 	<ul style="list-style-type: none"> • Replacement Stone Shield For Rallye 1000 Series Lamps: This stone shield is a replacement for the Rallye 1000 series lamps and provides protection. • Classic design 		<u>130331001</u>

CONVERSION HEADLAMPS

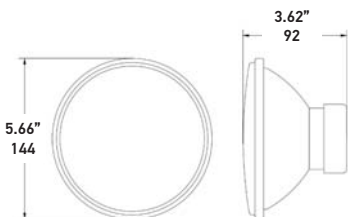

5 1/4" Sealed Beam Conversion Headlamps

Ideal For
Retrofitting
Replaces old sealed beam lighting technology

Features
Produces 50% more powerful beam on low beam
Produces 25% more powerful beam on high beam
Single lamp fits left or right
ECE versions for off-road use only in USA
Dust boots included

002850811
High/Low Beam (ECE), Kit, 2 H4 12 V 60/55W Bulbs, 2 Wiring Adapter Harnesses

002850871
High/Low Beam (ECE), 1 H4 12 V 60/55W Bulb, 1 Wiring Adapter Harness

002425811
High Beam (ECE), Kit, 2 H1 12 V 55W Bulbs, 4 Adapter Wires

002425901
High Beam (ECE), 1 H1 12 V 55W Bulb, 2 Adapter Wires

Product image /
Dimensions

Features

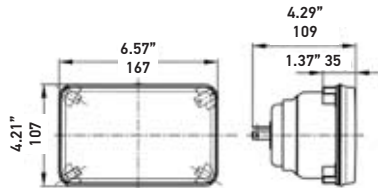

4" x 6" Rectangular Conversion Headlamps

Ideal For

Retrofitting
Replaces old sealed beam lighting technology

Features

Produces 50% more powerful beam on low beam
Produces 25% more powerful beam on high beam
Single lamp fits left or right
ECE versions for off-road use only in USA
Dust boots included

003177862

High/Low Beam (ECE), 1 H4 12 V 60/55W Bulb, 1 Wiring Adapter Harness

Part Number

003177821

High Beam (ECE), Kit, 2 H1 12 V 55W Bulbs, 4 Adapter Wires

003177871

High Beam (ECE), 1 H1 12 V 55W Bulb, 2 Adapter Wires

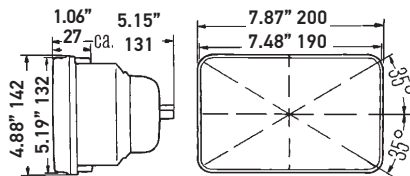

Vision Plus 6" x 7" Rectangular Conversion Headlamps

Ideal For

Retrofitting
Replaces old sealed beam lighting technology

Features

Based on European headlamp technology
Brighter than a standard halogen due to improved optics without increased glare
Produces 50% more powerful beam on low beam
Produces 25% more powerful beam on high beam
Single lamp fits left or right
Replaces standard sealed beam 6052, 6053, H6052, H6054
Direct fit – no modification
Dust boots included
ECE versions for off-road use only in the USA

Part Number

003427811 High/Low Beam (ECE), Kit, 2 H4 12 V 60/55W Bulbs

003427291 High/Low Beam (SAE/DOT), 1 HB2/9003 12 V 60/55W Bulb

003427861 High/Low Beam (ECE), 1 H4 12 V 60/55W Bulb

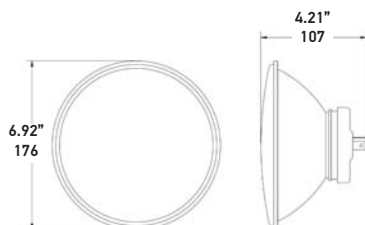

Vision Plus 7" Round Conversion Headlamps

Ideal For

Retrofitting older sealed beam lamps to newer halogen replaceable bulbs

Features

Based on European headlamp technology
Brighter than a standard halogen due to improved optics without increased glare
Produces 50% more powerful beam on low beam
Produces 25% more powerful beam on high beam
Single lamp fits left or right
Replaces 6012, 6014, 6015, 6016, 6017, H6024, H6014, H6017, H6026
Direct replacement for older sealed beam bulbs – no modifications
Direct fit – no modification
Dust boots included

Part Number

002395801 High/Low Beam (ECE), Kit, 2 H4 12 V 60/55W Bulbs

002395301 High/Low Beam (SAE/DOT), 1 HB2/9003 12 V 60/55W Bulb

002395991 High/Low Beam (ECE), 1 H4 12 V 60/55W Bulb

90 MM LED MODULES

The new L4060 LED series is the new addition to the range of 90 millimeter LED modules. This makes HELLA the only supplier in the market to provide a replacement concept for all 90 millimeter halogen modules using LED technology. The design of the new module is very compact and allows three light functions in one module without additional electronics. The resistant cover plate of polycarbonate and the cast aluminum housing are extremely robust and can withstand even tougher loads. The new L4060 LED series give you more illumination and safety with innovative LED technology.

90 MM CONFIGURATOR

This tool shows you the options for equipping or upgrading a vehicle with 90 mm LED modules. See images from Europe's biggest light testing facility and compare the light distribution of halogen and LED modules, in order to help you make the right choice for your application.



www.hella.com/90mm-modules

90MM MODULES

Program Overview

- For the most diverse applications and for the most demanding needs
- Maximum technological and design freedom thanks to its modular system
- Increased lighting and safety thanks to innovative LED technology

	LED	Halogen (conventional lighting technology)
Main light functions	<ul style="list-style-type: none"> → Low beam and high beam (bi-modules) → Low beam → Low beam with daytime running light and position light → High beam → High beam with daytime running light and position light → High beam and direction indicator light 	<ul style="list-style-type: none"> → Low beam and high beam (bi-modules) → Low beam → High beam → High beam and position light
Auxiliary light functions	<ul style="list-style-type: none"> → Fog light → Fog light and cornering light → Fog light, daytime running light and position light → Daytime running light → Daytime running light and position light → Direction indicator light, daytime running light and position light 	<ul style="list-style-type: none"> → Fog light → Fog light and cornering light → Fog light and daytime running light → Daytime running light and position light → Position light → Direction indicator light and position light → Direction indicator light

90 mm modules

Configurator

Powerful, cost-efficient and modular. Put together your customized front lighting from our wide range of 90 mm modules.

www.hella.com/headlamp-modules



90 MM LED MODULES



Product image / Dimensions	Features	Technical Specifications	Part Number
----------------------------	----------	--------------------------	-------------

**L4060 LED
BI-LED GEN II
HIGH / LOW BEAM**

LED

- Headlight module
- Polycarbonate lens
- Cast aluminum housing
- Black finish cover
- Dipped beam: 20 Watt
- Voltage: 9 - 33 V
- Connection: DT connector
- Approval: SAE / ECE

Mounting:

- Flush

Applications:







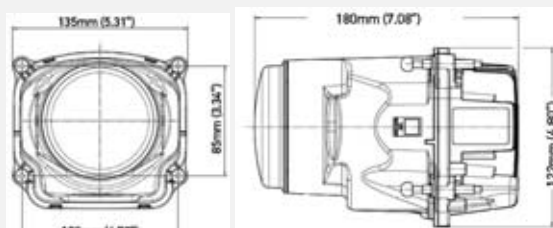

- Universal application
- Headlight update

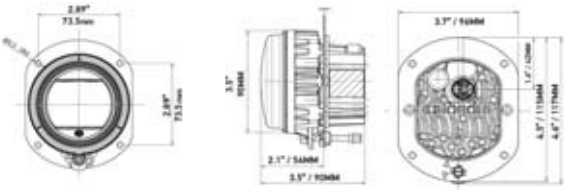

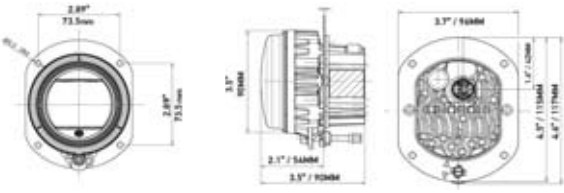
Content:

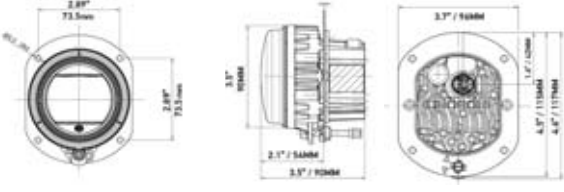

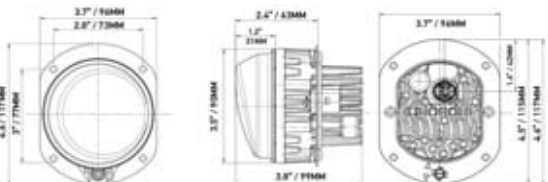
- 1 Headlights, Mounting instructions and installation components

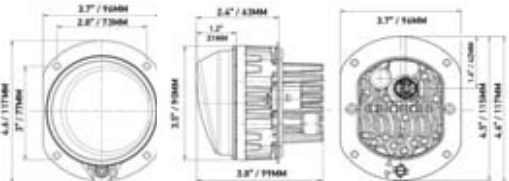

012758121 Homologation SAE

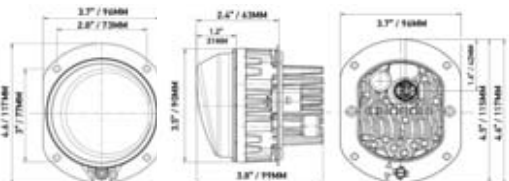

Product image / Dimensions	Features	Technical Specifications	Part Number
<p>L4060 LED LED HIGH BEAM WITH DAYTIME RUNNING/ POSITION LIGHT</p>  <p>Pre-mounted carrier frame</p>	<p>LED</p> <ul style="list-style-type: none"> • Headlamp module with low beam, position and daylight (DRL) • Polycarbonate lens • Cast aluminum housing • Silver design cover • Black finish cover on request • Voltage: 9 - 32 VDC • Power Consumption: 20 Watt • Integrated 4-pin DT connector • Approval: ECE / SAE 	<p>Mounting:</p> <ul style="list-style-type: none"> • Flush <p>Applications:</p> <ul style="list-style-type: none"> • Universal application • Headlight update <p>Content:</p> <ul style="list-style-type: none"> • 1 Headlight, Mounting instructions and installation components 	<p>011988031 Pre-mounted carrier frame</p> <p>011988131 Performance mount</p> <p>202117001 DT conversion connector</p> 
<p>L4060 LED LED HIGH BEAM</p>  <p>Pre-mounted carrier frame</p>	<p>LED</p> <ul style="list-style-type: none"> • Headlight module • Polycarbonate lens • Cast aluminum housing • Silver design cover • Black finish cover on request • Voltage: 9 - 32 VDC • Power Consumption: 20 Watt • Integrated 4-pin FEP connector (Power connector DT conversion available - sold separately) • Approval: ECE / SAE 	<p>Mounting:</p> <ul style="list-style-type: none"> • Flush <p>Applications:</p> <ul style="list-style-type: none"> • Universal application • Headlight update <p>Content:</p> <ul style="list-style-type: none"> • 1 Headlight, Mounting instructions and installation components 	<p>011988021 Pre-mounted carrier frame</p> <p>011988121 Performance mount</p> <p>202117001 DT conversion connector</p> 
<p>L4060 LED LED HIGH BEAM WITH TURN SIGNAL</p> 	<p>LED</p> <ul style="list-style-type: none"> • Headlight module • Polycarbonate lens • Cast aluminum housing • Silver design cover • Black finish cover on request • Only for vehicles below 80" in width • Voltage: 9 - 32VDC • Power Consumption: 20 Watt • Integrated 4-pin FEP connector (Power connector DT conversion available - sold separately) • Approval: ECE / SAE 	<p>Mounting:</p> <ul style="list-style-type: none"> • Flush <p>Applications:</p> <ul style="list-style-type: none"> • Universal application • Headlight update <p>Content:</p> <ul style="list-style-type: none"> • 1 Headlight, Mounting instructions and installation components 	<p>011988071 With carrier frame without pulse generator</p> <p>011988171 Performance mount without pulse generator</p> <p>202117001 DT conversion connector</p> 
<p>L4060 LED FOG LIGHT WITH CURVE LIGHT</p> 	<p>LED</p> <ul style="list-style-type: none"> • Headlight module • Polycarbonate lens • Cast aluminum housing • Silver design cover • Black finish cover on request • Voltage: 9 - 32VDC • Power Consumption: 20 Watt • Integrated 4-pin FEP connector (Power connector DT conversion available - sold separately) • Approval: ECE / SAE 	<p>Mounting:</p> <ul style="list-style-type: none"> • Flush <p>Applications:</p> <ul style="list-style-type: none"> • Universal application • Headlight update <p>Content:</p> <ul style="list-style-type: none"> • 1 Headlight, Mounting instructions and installation components 	<p>011988051 Light Left Hand</p> <p>011988061 Light Right Hand</p> 

Product image / Dimensions	Features	Technical Specifications	Part Number
L4060 LED LED FOG LIGHT 	LED <ul style="list-style-type: none"> • Headlight module • Polycarbonate lens • Cast aluminum housing • Silver design cover • Black finish cover on request • Voltage: 9 - 32 VDC • Power Consumption: 20 Watt • Integrated 4-pin FEP connector (Power connector DT conversion available - sold separately) • Approval: SAE 	Mounting: • Flush Applications: • Universal application • Headlight update Content: • (1) Headlight, Mounting instructions and installation components	011988001 Pre-mounted carrier frame
			202117001 DT conversion connector 

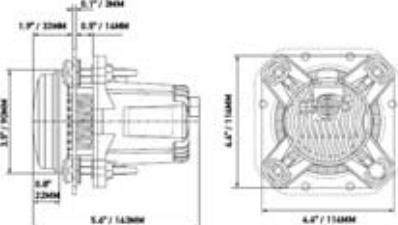
L4060 LED LED FOG LIGHT WITH DAYTIME RUNNING/ POSITION LIGHT 	LED <ul style="list-style-type: none"> • Headlight module • Polycarbonate lens • Cast aluminum housing • Silver design cover • Black finish cover on request • Voltage: 9 - 32 VDC • Power Consumption: 20 Watt • Integrated 4-pin FEP connector (Power connector DT conversion available - sold separately) • Approval: SAE 	Mounting: • Flush Applications: • Universal application • Headlight update Content: • (1) Headlight, Mounting instructions and installation components	011988011 Pre-mounted carrier frame
			202117001 DT conversion connector 

L4060 LED LED LOW BEAM 	LED <ul style="list-style-type: none"> • Headlight module • Polycarbonate lens • Cast aluminum housing • Silver design cover • Voltage: 9 - 32 VDC • Power Consumption: 20 Watt • Integrated DT connector • Approval: SAE / ECE 	Mounting: • Flush Applications: • Universal application • Headlight update Content: • (1) Headlight, Mounting instructions and installation components	012488101
			012488121 With Daytime Running /Position Light 

90 MM LED - ACCESSORIES AND SPARE PARTS

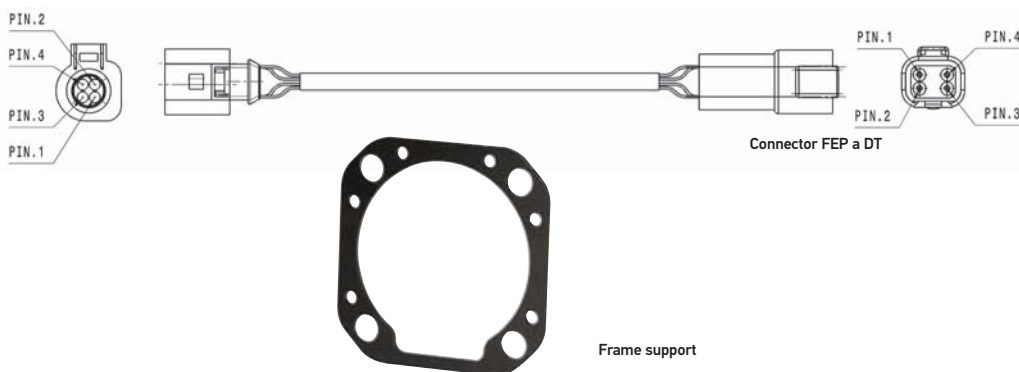

169580011	Frame support
202117001	FEP to DT connector

R 80 LED

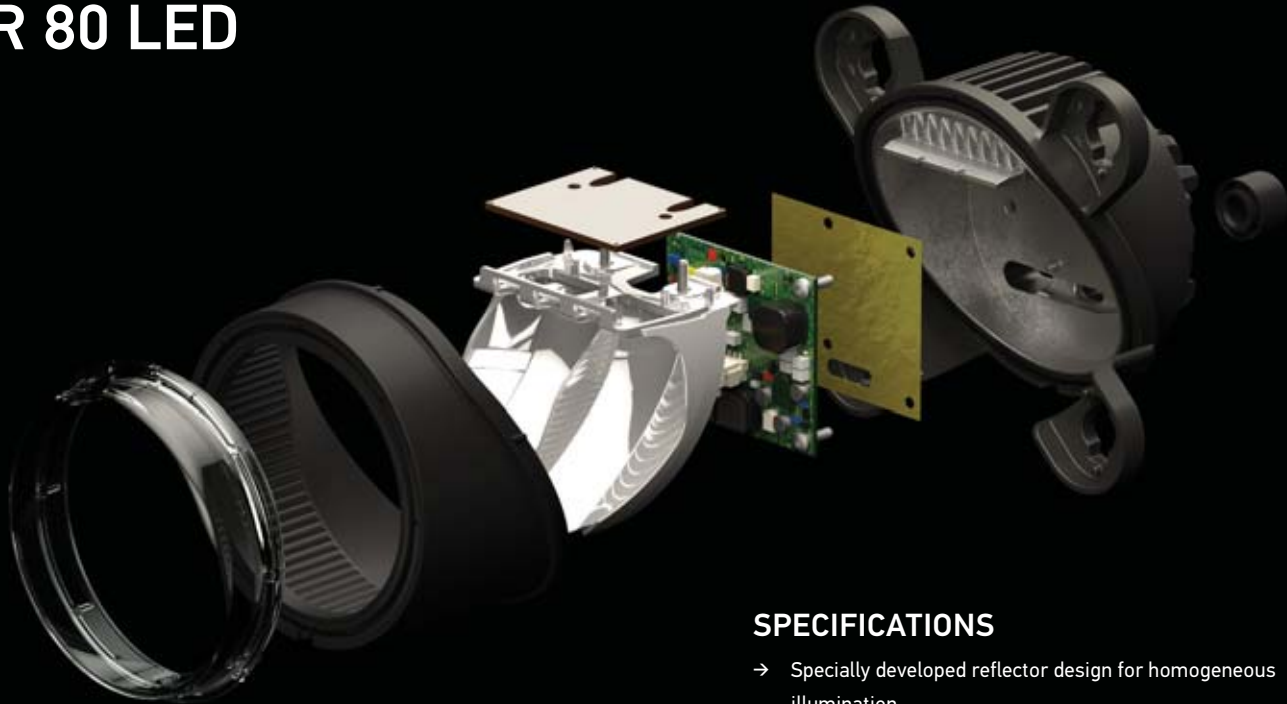

SPECIFICATIONS

- Specially developed reflector design for homogeneous illumination
- Compact and robust design
- Enables a cost-effective switch from halogen to LED
- Optional FEP or DEUTSCH connector

Product image / Dimensions	Features	Technical Specifications	Part Number
----------------------------	----------	--------------------------	-------------

R 80 LED HIGH BEAM LED

LED

- High beam headlight module
- Polycarbonate lens
- Plastic housing
- Silver design cover
- Black finish cover
- Voltage: 9 - 32 VDC
- Power consumption: 20 Watt
- Integrated 4-pin DT connector
- Approval: ECE / SAE
- Protection: IP X9K, IP X4K, IP 5KX

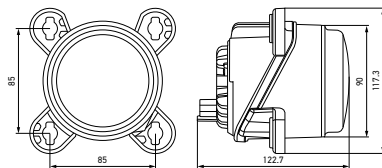

- Mounting:
- Recessed

- Applications:
- Universal application
 - Headlight upgrade

- Contents:
- 1 headlight, assembly instructions and installation components

- 015050001*** ECE, connector DT
- 015050011*** ECE, connector DT
- 015050031*** SAE, connector DT
- 015050151**** SAE, connector DT
- 015050101*** ECE, connector FEP
- 015050111*** ECE, connector FEP
- 015050131*** SAE, connector FEP

* Mounting kit 25416300 not included in delivery.
** Mounting kit 25416300 included in delivery.

R 80 LED LOW BEAM LED

LED

- Low beam headlight module
- Polycarbonate lens
- Plastic shell
- Silver design cover
- Black finish cover
- Voltage: 9 - 32 VDC
- Power consumption: 20 Watt
- Integrated 4-pin DT connector
- Approval: ECE / SAE
- Protection: IP X9K, IP X4K, IP 5KX

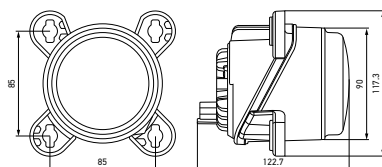

- Mounting:
- Recessed

- Applications:
- Universal application
 - Headlight upgrade

- Contents:
- 1 headlight, assembly instructions and installation components

- 015050021*** ECE, SAE, connector DT
- 015050141**** ECE, SAE, connector DT
- 015050121**** ECE, SAE, connector FEP

* Mounting kit 25416300 not included in delivery.
** Mounting kit 25416300 included in delivery.

A SOPHISTICATED SOLUTION: the smart module selector

Find the right headlamp module in just a few clicks:

Our smart module selector will make your search easier. Simply use the filter to select the required criteria, such as the lighting function or homologation, and you will see suitable products right away.

www.hella.com/headlamp-modules



+ Simple menu structure and use

Our module selector is easy to use and makes it simple for original equipment manufacturers and end customers to find the right module – just like its predecessor, which has already proved its worth in practice. We have built on this and added further module types to the configurator.

+ Illumination comparison

Compare the lighting technology for selected main light functions: Spot the difference between halogen and LED with realistic images from Europe's largest light testing facility! Compare the light distribution and choose the one that suits your application.

+ Upgrade to modern LED technology

Existing halogen versions can be easily converted to LED modules. More detailed information is found in the assembly instructions supplied with the LED modules.

+ It is easy to order parts

Use the selector to easily create your order list and send it to HELLA.

+ Precise comparison

All key technical details for each module can be found in the detailed overview – including optional accessories!

SHAPELINE

DESIGN YOUR LIGHT

www.hella.com/shapeline



Configuration examples

INDIVIDUAL LIGHTING SIGNATURE!

The variety and range of shapes and the various combination options paired with a technically optimized product design make the new Shapeline series a true innovation in vehicle lighting.

Whether the front, side or rear of a vehicle, whatever size or series, being it small or large. Shapeline offers a unique and, above all, consistent look using a customized configuration and arrangement of lamps. This allows us to meet the demands of vehicle manufacturers with lower numbers of manufactured vehicles. Along with innovative variety of shapes of Shapeline lamps provide you with nearly infinite design freedom.

Tech or Style: The HELLA Shapeline series provides design freedom for nearly any application and vehicle, achieves a consistent light signature for your vehicle at the same time.

Design your light – with HELLA Shapeline!



DESIGN WITH EASE

www.hella.com/shapeline

- Premium Design
- Customizable
- ECE and SAE
- Multivolt
- Robust
- Simple



HELLA *VALUEFIT*



HELLA VALUEFIT

Products for the toughest working conditions



HELLA VALUEFIT offers entry-level access to LED technology and represents a good solution for converting from halogen to LED. Compared to halogen work lights, LED work lights offer considerably better light output. The substantially higher color temperature of 6,000 Kelvin is very similar to natural daylight. This makes it easier to distinguish between different colors in the dark and, in turn, prevents the eyes from tiring quickly during work at night. VALUEFIT LED work lights are completely maintenance-free and offer a much longer service life than the bulb of a halogen headlamp.

HELLA products are measured in our inhouse state of the art light laboratory. HELLA is proud to be one of a few, who actually just advertise the **real measured lumen** for our light output.

Be aware that a lot of competitors advertise their products with a theoretical raw or calculated light output, which can be far off the actual light output you get. With HELLA you can be sure, that the lights will meet your expectations and do provide the right amount of light for every application.



MICROSITE: Find more information about HELLA VALUEFIT work lights at:







www.hellahd.com

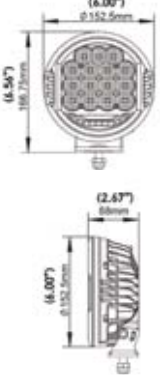

The products in this section can expose you to chemicals including Di(2-ethylhexyl) phthalate (DEHP), which is known to the State of California to cause cancer and birth defects or other reproductive harm. For more information go to [www. P65Warnings.ca.gov](http://www.P65Warnings.ca.gov)

HELLA VALUEFIT AUXILIARY LIGHTS

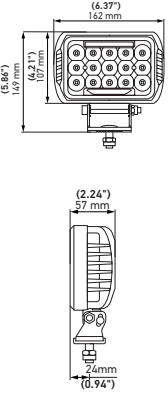
Perfect replacement of your traditional Halogen Auxiliary lights.
Equal in size and shape, but much higher light performance
combined with a modern design and longer durability.

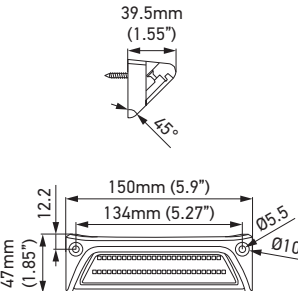
Product image / Dimensions	Features																						
<p>500 LED DRIVING LAMP</p>  <p>2100 lm</p> <p style="writing-mode: vertical-rl; transform: rotate(180deg);">LED</p> 	<p>Round LED Auxiliary light with high performance LEDs and stylish PO light. The 500 LED comes with a black stone shield cover. 2100 measured lumen and IP67 protection Off-road use only. Amber cover converts the 500 LED to a Fog lamp for dusty or foggy environments. Kit contains: (2) LED driving lights, stone shields, mounting brackets and hardware, (1) relay, switch and wiring harness</p> <table border="1"> <tr><td>Voltage</td><td>10-30 VDC</td></tr> <tr><td>Light pattern:</td><td>Driving Beam</td></tr> <tr><td>Light source:</td><td>LED</td></tr> <tr><td>Power consumption:</td><td>22.5 Watt</td></tr> <tr><td>Color temperature:</td><td>6000 Kelvin</td></tr> <tr><td>Housing material:</td><td>Aluminum</td></tr> <tr><td>Connection:</td><td>Wire leads (Single) / DT connector (Kit)</td></tr> <tr><td>Mounting:</td><td>Stainless steel bracket</td></tr> <tr><td>Dimensions:</td><td>6.0" x 6.6" x 2.7" / 153 x 167 x 68 mm (WxHxD)</td></tr> <tr><td>Approvals:</td><td>CE, ECE-R10, ECE-R112, IP67</td></tr> <tr><td>Part Number</td><td>358117161 Single 358117171 Kit 358116991 Amber stone shield</td></tr> </table>	Voltage	10-30 VDC	Light pattern:	Driving Beam	Light source:	LED	Power consumption:	22.5 Watt	Color temperature:	6000 Kelvin	Housing material:	Aluminum	Connection:	Wire leads (Single) / DT connector (Kit)	Mounting:	Stainless steel bracket	Dimensions:	6.0" x 6.6" x 2.7" / 153 x 167 x 68 mm (WxHxD)	Approvals:	CE, ECE-R10, ECE-R112, IP67	Part Number	358117161 Single 358117171 Kit 358116991 Amber stone shield
Voltage	10-30 VDC																						
Light pattern:	Driving Beam																						
Light source:	LED																						
Power consumption:	22.5 Watt																						
Color temperature:	6000 Kelvin																						
Housing material:	Aluminum																						
Connection:	Wire leads (Single) / DT connector (Kit)																						
Mounting:	Stainless steel bracket																						
Dimensions:	6.0" x 6.6" x 2.7" / 153 x 167 x 68 mm (WxHxD)																						
Approvals:	CE, ECE-R10, ECE-R112, IP67																						
Part Number	358117161 Single 358117171 Kit 358116991 Amber stone shield																						
<p>450 LED DRIVING LAMP</p>  <p>3000 lm</p> <p style="writing-mode: vertical-rl; transform: rotate(180deg);">LED</p> 	<p>Rectangular LED Auxiliary light with high performance LEDs and stylish PO light. The 450 LED comes with a black stone shield cover. 3000 measured lumen and IP67 protection. Off-road use only. Kit contains: (2) LED driving lights, stone shields, mounting brackets and hardware, (1) relay, switch and wiring harness.</p> <table border="1"> <tr><td>Voltage</td><td>10-30 VDC</td></tr> <tr><td>Light pattern:</td><td>Driving Beam</td></tr> <tr><td>Light source:</td><td>LED</td></tr> <tr><td>Power consumption:</td><td>75 Watt</td></tr> <tr><td>Color temperature:</td><td>6000 Kelvin</td></tr> <tr><td>Housing material:</td><td>Aluminum</td></tr> <tr><td>Connection:</td><td>Wire leads</td></tr> <tr><td>Mounting:</td><td>Stainless steel bracket</td></tr> <tr><td>Dimensions:</td><td>6.4" x 5.9" x 2.2" / 162 x 149 x 57 mm (WxHxD)</td></tr> <tr><td>Approvals:</td><td>CE, ECE-R10, ECE-R112, IP67</td></tr> <tr><td>Part Number</td><td>358154041 Single 358154051 Kit 358154061 Amber stone shield</td></tr> </table>	Voltage	10-30 VDC	Light pattern:	Driving Beam	Light source:	LED	Power consumption:	75 Watt	Color temperature:	6000 Kelvin	Housing material:	Aluminum	Connection:	Wire leads	Mounting:	Stainless steel bracket	Dimensions:	6.4" x 5.9" x 2.2" / 162 x 149 x 57 mm (WxHxD)	Approvals:	CE, ECE-R10, ECE-R112, IP67	Part Number	358154041 Single 358154051 Kit 358154061 Amber stone shield
Voltage	10-30 VDC																						
Light pattern:	Driving Beam																						
Light source:	LED																						
Power consumption:	75 Watt																						
Color temperature:	6000 Kelvin																						
Housing material:	Aluminum																						
Connection:	Wire leads																						
Mounting:	Stainless steel bracket																						
Dimensions:	6.4" x 5.9" x 2.2" / 162 x 149 x 57 mm (WxHxD)																						
Approvals:	CE, ECE-R10, ECE-R112, IP67																						
Part Number	358154041 Single 358154051 Kit 358154061 Amber stone shield																						
<p>SM2000</p>  <p style="writing-mode: vertical-rl; transform: rotate(180deg);">LED</p> 	<p>The SMS2000 LED work lamp is recommended whenever effective uniform ground illumination by a vertically mounted work lamp is required. This function is particularly appreciated by campers, trucks, lorry drivers and service vehicles. With dual light function White: Work lamp / Amber: Ambient light Slender compact design. Perfect design for a wide range of applications. Homogeneous and wide-area light distribution</p> <table border="1"> <tr><td>Voltage</td><td>12 / 24 VDC</td></tr> <tr><td>Light pattern:</td><td>Extra wide illumination</td></tr> <tr><td>Light source:</td><td>LED</td></tr> <tr><td>Power consumption:</td><td>19 Watt (white)/ 10 W (white/amber)</td></tr> <tr><td>Color temperature:</td><td>6000 Kelvin</td></tr> <tr><td>Housing material:</td><td>Die-cast aluminium</td></tr> <tr><td>Connection:</td><td>Cable length: 500 mm, open cable ends</td></tr> <tr><td>Mounting:</td><td>Stainless steel bracket</td></tr> <tr><td>Dimensions:</td><td>5.9" x 1.85" x 1.55" / 150 x 47 x 39.5 mm (WxHxD)</td></tr> <tr><td>Approvals:</td><td>ECE-R10, UKCA, RCM, IP 6K9K, IP 6K8</td></tr> <tr><td>Part Number</td><td>357098001 Single light, white 357098011 Dual function white / amber (switchable)</td></tr> </table>	Voltage	12 / 24 VDC	Light pattern:	Extra wide illumination	Light source:	LED	Power consumption:	19 Watt (white)/ 10 W (white/amber)	Color temperature:	6000 Kelvin	Housing material:	Die-cast aluminium	Connection:	Cable length: 500 mm, open cable ends	Mounting:	Stainless steel bracket	Dimensions:	5.9" x 1.85" x 1.55" / 150 x 47 x 39.5 mm (WxHxD)	Approvals:	ECE-R10, UKCA, RCM, IP 6K9K, IP 6K8	Part Number	357098001 Single light, white 357098011 Dual function white / amber (switchable)
Voltage	12 / 24 VDC																						
Light pattern:	Extra wide illumination																						
Light source:	LED																						
Power consumption:	19 Watt (white)/ 10 W (white/amber)																						
Color temperature:	6000 Kelvin																						
Housing material:	Die-cast aluminium																						
Connection:	Cable length: 500 mm, open cable ends																						
Mounting:	Stainless steel bracket																						
Dimensions:	5.9" x 1.85" x 1.55" / 150 x 47 x 39.5 mm (WxHxD)																						
Approvals:	ECE-R10, UKCA, RCM, IP 6K9K, IP 6K8																						
Part Number	357098001 Single light, white 357098011 Dual function white / amber (switchable)																						

Product image / Dimensions	Features
----------------------------	----------

4LED CUBE

LED

600 lm

Flood Beam

690 lm

Spot Beam

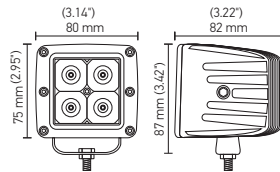

Compact LED cubes with great light distribution, both in flood and spot beam pattern. The wide 90 degree spread flood beams provide perfect light conditions around your vehicle. The far reaching spot beams provide additional light in front of your vehicle. 1 year warranty.

Kit contains: (2) LED lights, mounting brackets and hardware, (1) relay, switch and wiring harness with DT connector

Voltage	10-30 VDC
Light pattern:	Spot Beam / Flood Beam
Light source:	LED
Power consumption:	12 Watt / 24 Watt (Kit)
Color temperature:	6000 Kelvin
Housing material:	Aluminum
Connection:	Wire leads (Single) / DT connector (Kit)
Mounting:	Stainless steel bracket
Dimensions:	3.1" x 3.4" x 3.2" / 80 x 75 x 82 mm (WxHxD)
Approvals:	IP67

Part Number

357204821 Kit, Spot Beam, Black housing
357204031 Flood Beam, Black housing
357204041 Flood Beam, White housing
357204831 Kit, Flood Beam, Black housing

6LED CUBE

LED

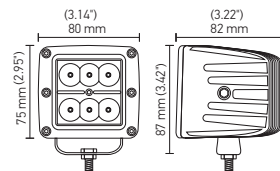
600 lm

The compact square design combined with 6 powerful LEDs are the perfect combination for you. Available as surface bracket mount or with a special flush mount cover to install it direct into the bumper. 1 year warranty.

Voltage	10-30 VDC
Light pattern:	Flood Beam
Light source:	LED
Power consumption:	18 Watt
Color temperature:	6000 Kelvin
Housing material:	Aluminum
Connection:	Wire leads
Mounting:	Stainless steel bracket
Dimensions:	3.1" x 3.4" x 3.2" / 80 x 75 x 82 mm (WxHxD)
Approvals:	IP67

Part Number

357204051 Flood Beam

6LED CUBE

LED

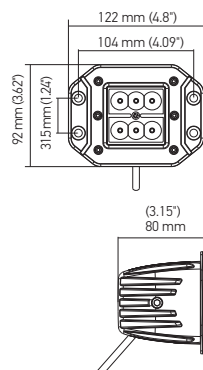
1000 lm

6LED Cube Flush Mount

The compact square design combined with 6 powerful LEDs are the perfect combination for you. Available as surface bracket mount or with a special flush mount cover to install it direct into the bumper. 1 year warranty.

Voltage	10-30 VDC
Light pattern:	Flood Beam
Light source:	LED
Power consumption:	18 Watt
Color temperature:	6000 Kelvin
Housing material:	Aluminum
Connection:	Wire leads
Mounting:	Stainless steel bracket
Dimensions:	4.8" x 3.6" x 3.1" / 122 x 92 x 80 mm (WxHxD)
Approvals:	IP67

Part Number

357204021 Flood Beam

Product image / Dimensions	Features
----------------------------	----------

7" ROUND

LED



1080 lm

Driving Beam



3000 lm

Spot Beam

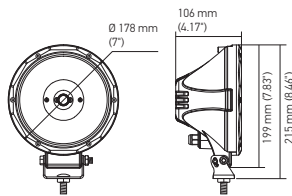

Classic 7" round Aux lights reflector design combined with modern LED technology. Powerful spot beam provides a bright and narrow light beam for good sight and safe maneuvering on and off the road. 1 year warranty.

Voltage	10-30 VDC
Light pattern:	Driving Beam
Light source:	LED
Power consumption:	20 Watt
Color temperature:	6000 Kelvin
Housing material:	Aluminum
Connection:	Wire leads
Mounting:	Stainless steel bracket
Dimensions:	7.0" x 8.5" x 4.2" / 178 x 178 x 106 mm (WxHxD)
Approvals:	IP67 / SAE, ECE (Driving Beam)

Part Number	357200001 Driving Beam
	357200011 Spot Beam

90MM SPOT LIGHT

LED



1000 lm

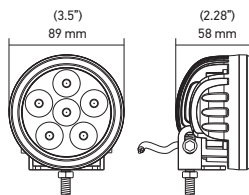

The compact round design combined with 6 powerful LEDs are the perfect combination for you. Available as surface bracket mount or with a special flush mount cover to install it direct into the bumper. 1 year warranty.

Voltage	10-30 VDC
Light pattern:	Spot Beam
Light source:	LED
Power consumption:	18 Watt
Color temperature:	6000 Kelvin
Housing material:	Aluminum
Connection:	Wire leads
Mounting:	Stainless steel bracket
Dimensions:	3.5" x 3.5" x 2.3" / 89 x 89 x 58 mm (WxHxD)
Approvals:	IP67

Part Number	357201001 Spot Beam
--------------------	----------------------------

90MM SPOT LIGHT
FLUSH MOUNT

LED



1000 lm

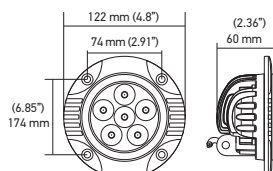

The compact round design combined with 6 powerful LEDs are the perfect combination for you. Available as surface bracket mount or with a special flush mount cover to install it direct into the bumper. 1 year warranty.

Voltage	10-30 VDC
Light pattern:	Spot Beam
Light source:	LED
Power consumption:	18 Watt
Color temperature:	6000 Kelvin
Housing material:	Aluminum
Connection:	Wire leads
Mounting:	Stainless steel bracket
Dimensions:	4.8" x 4.8" x 2.4" / 122 x 122 x 60 mm (WxHxD)
Approvals:	IP67

Part Number	357201011 Spot Beam
--------------------	----------------------------

Product image / Dimensions	Features
----------------------------	----------

6LED MINN LIGHTBAR

LED



1000 lm

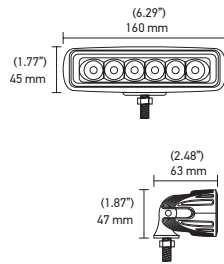

Thanks to its 6 high power LEDs, it is a top seller in this range. The low profile shape and the adjustable mounting bracket make this lamp a desired addition to any vehicle. 1 year warranty.

Voltage	10-30 VDC
Light pattern:	Flood Beam
Light source:	LED
Power consumption:	18 Watt
Color temperature:	6000 Kelvin
Housing material:	Aluminum
Connection:	Wire leads
Mounting:	Stainless steel bracket
Dimensions	6.3" x 1.8" x 2.5" / 160 x 45 x 63 mm (WxHxD)
Approvals:	IP67
Part Number	357203001 Flood, Black housing 357203051 Flood, White housing

6LED MINI LIGHTBAR

LED



1000 lm

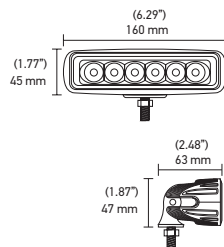

Thanks to its 6 high power LEDs, it is a top seller in this range. The low profile shape and the adjustable mounting bracket make this lamp a desired addition to any vehicle. 1 year warranty.

Voltage	10-30 VDC
Light pattern:	Flood Beam
Light source:	LED
Power consumption:	18 Watt
Color temperature:	6000 Kelvin
Housing material:	Aluminum
Connection:	Wire leads
Mounting:	Stainless steel bracket
Dimensions	6.3" x 1.8" x 2.5" / 160 x 45 x 63 mm (WxHxD)
Approvals:	IP67
Part Number	357203011 Spot, Black housing

6LED MINI LIGHTBAR FLUSH MOUNT

LED



1000 lm

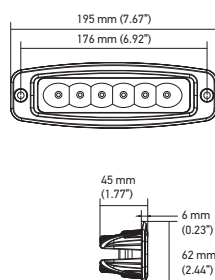

Thanks to its 6 high power LEDs, it is a top seller in this range. The low profile shape and the adjustable mounting bracket make this lamp a desired addition to any vehicle. The flush mount housing works perfect for the install direct into the bumper. 1 year warranty.

Voltage	10-30 VDC
Light pattern:	Flood Beam
Light source:	LED
Power consumption:	18 Watt
Color temperature:	6000 Kelvin
Housing material:	Aluminum
Connection:	Wire leads
Mounting:	Stainless steel bracket
Dimensions	7.7" x 2.4" x 1.8" / 195 x 62 x 45 mm (WxHxD)
Approvals:	IP67
Part Number	357203031 Flood, Black Housing

HELLA VALUEFIT LBE SERIES

- 1 Powerful light output thanks to the latest LED technology, in shock-resistant aluminum housing with integrated cooling fins
- 2 Position light with distinctive appearance (LBE 320 and 480 version)
- 3 Various fixing options are possible thanks to the flexible mounting system, its fixing screws allow adjustments to the angles of inclination
- 4 For universal use in all types of vehicles such as 4x4, SUV, pickup trucks, commercial vehicles



COLOR TEMPERATURE

- The color temperature is similar to natural light.
- Drivers operating in such lighting conditions stay alert longer.

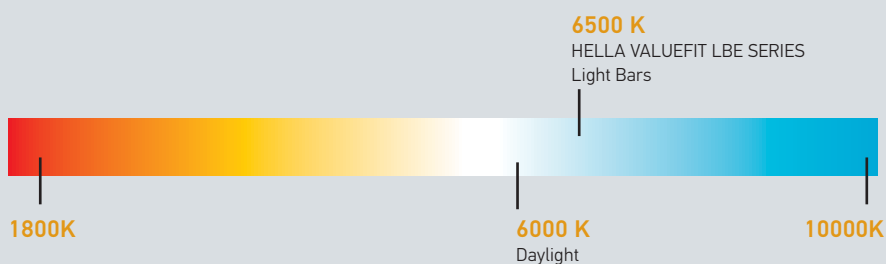

Product image / Dimensions	Features
----------------------------	----------

HELLA VALUEFIT LBE 160

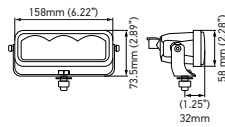
2000 lm

Innovative lens design for a stealthy look. The low mounting position offers exceptional surface illumination. Frameless design prevents dust deposits from settling on the edges. 1 year warranty.

Voltage	10-48 VDC
Light pattern:	Driving beam
Light source:	LEDs
Energy consumption:	22 Watt
color temperature:	6500 Kelvin
Shell material:	Aluminum
Connection:	Integrated DT connector + 7ft (2000mm) adapter cable with open leads
Mounting:	stainless steel bracket
Dimensions:	6.22" x 2.89" x 2.28" / 158 x 74 x 72mm (WxHxD)
Approvals:	ECE R10, ECE R112, IP67
Part number	358154011 Driving beam

HELLA VALUEFIT LBE 320

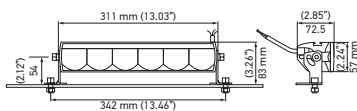
3500 lm
With LED Position Light

Innovative lens design for a stealthy look. The low mounting position offers exceptional surface illumination. Frameless design prevents dust deposits from settling on the edges. 1 year warranty.

Voltage	10-48 VDC
Light pattern:	Driving beam
Light source:	LEDs
Energy consumption:	48 Watt
color temperature:	6500 Kelvin
Shell material:	Aluminum
Connection:	Integrated DT connector + 7ft (2000mm) adapter cable with open leads
Mounting:	stainless steel bracket
Dimensions	13.03" x 3.26" x 2.85" / 311 x 83 x 72mm (WxHxD)
Approvals:	ECE R10, ECE R112, IP67
Part number:	358154001 Driving beam

HELLA VALUEFIT LBE 480

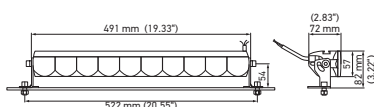
6200 lm
With LED Position Light

Innovative lens design for a stealthy look. The low mounting position offers exceptional surface illumination. Frameless design prevents dust deposits from settling on the edges. 1 year warranty.

Voltage	10-48 VDC
Light pattern:	Long-range
Light source:	LEDs
Energy consumption:	53 Watt
color temperature:	6500 Kelvin
Shell material:	Aluminum
Connection:	Integrated DT connector + 7ft (2000mm) adapter cable with open leads
Mounting:	stainless steel bracket
Dimensions	19.33" x 3.22" x 2.85" / 491 x 83 x 72mm (WxHxD)
Approvals:	ECE R10, ECE R112, IP67
Part number:	358154021 Long Range

HELLA VALUEFIT LBX SERIES

- 1 Combo Beam.** A combination of a spot beam and flood beam for the LBX-540 & LBX-720
- 2 Diecast Aluminum Housing** able to withstand the elements.
- 3 Aluminum Alloy Brackets** for sturdy upright mounting. A perfect fit for roof, grille and bumper mounting.
- 4** An all around professional LED light bar, a perfect fit for your next race to out shine the competition!



Color Temperature

→ Color temperature is close to natural daylight.
Drivers operating in such lighting conditions
stay alert longer.

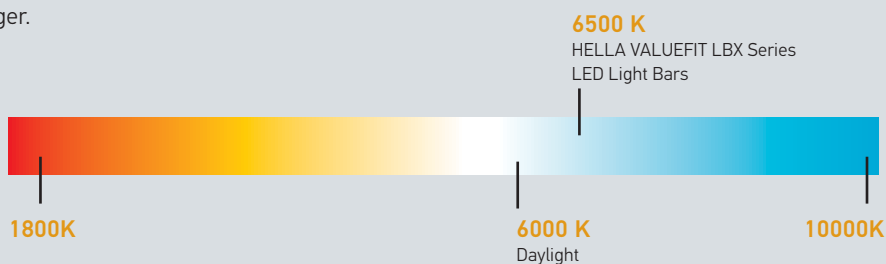

Product image / Dimensions	Features
----------------------------	----------

LBX 220 LED - 8"

8.2" (209 mm) 3.1" (80 mm)

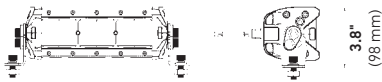
1000 lm

Innovative lens design for stealth look. Low mounting position offers exceptional ground illumination. 1 year warranty.

Voltage	9-30 VDC
Light pattern:	Flood Beam
Light source:	LED
Power consumption:	22 Watt
Color temperature:	6500 Kelvin
Housing material:	Aluminum
Connection:	Integrated DT connector + 7ft (2000mm) adapter cable with open wires
Mounting:	Stainless steel bracket
Dimensions	8.2" x 3.8" x 3.1" / 209 x 98 x 80 mm (WxHxD)
Approvals:	CE, ECE-R10, IP67
Part Number	360000002 Close Range

LBX 380 LED - 14"

14" (374 mm) 3.1" (80 mm)



2000 lm

Innovative lens design for stealth look. Low mounting position offers exceptional ground illumination. 1 year warranty.

Voltage	9-30 VDC
Light pattern:	Flood Beam
Light source:	LED
Power consumption:	44 Watt
Color temperature:	6500 Kelvin
Housing material:	Aluminum
Connection:	Integrated DT connector + 7ft (2000mm) adapter cable with open wires
Mounting:	Stainless steel bracket
Dimensions	14.0" x 3.8" x 3.1" / 374 x 98 x 80 mm (WxHxD)
Approvals:	CE, ECE-R10, IP67
Part Number	360001002 Combo Beam

LBX 540 LED - 21"

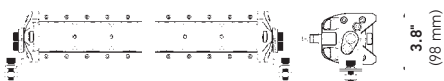
21" (539 mm) 3.1" (80 mm)



3500 lm

Innovative lens design for stealth look. Low mounting position offers exceptional ground illumination. The combination of Flood and Spot reflectors creates a far and wide illumination for maximum visibility at night. 1 year warranty.

Voltage	9-30 VDC
Light pattern:	Combo Beam
Light source:	LED
Power consumption:	66 Watt
Color temperature:	6500 Kelvin
Housing material:	Aluminum
Connection:	Integrated DT connector + 7ft (2000mm) adapter cable with open wires
Mounting:	Stainless steel bracket
Dimensions	21" x 3.8" x 3.1" / 539 x 98 x 80 mm (WxHxD)
Approvals:	CE, ECE-R10, ECE-R112, SAE approved, IP67
Part Number	360002002 Combo Beam

LBX 720 LED - 27"

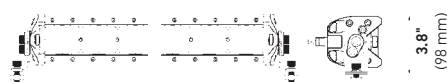
27" (704 mm) 3.1" (80 mm)

5500 lm

Innovative lens design for stealth look. Low mounting position offers exceptional ground illumination. The combination of Flood and Spot reflectors creates a far and wide illumination for maximum visibility at night. 1 year warranty.

Voltage	9-30 VDC
Light pattern:	Combo Beam
Light source:	LED
Power consumption:	88 Watt
Color temperature:	6500 Kelvin
Housing material:	Aluminum
Connection:	Integrated DT connector + 7ft (2000mm) adapter cable with open wires
Mounting:	Stainless steel bracket
Dimensions	27" x 3.8" x 3.1" / 704 x 98 x 80 mm (WxHxD)
Approvals:	CE, ECE-R10, ECE-R112, IP67
Part Number	360003002



HELLA VALUEFIT SPORT SERIES

- 1 Combo Beam.** A combination of a spot beam and flood beam.
- 2 Diecast Aluminum Housing** able to withstand the elements.
- 3 Aluminum Alloy Brackets** for sturdy upright mounting. A perfect fit for roof, grille and bumper mounting.
- 4** Get that off-road look whether you're on the street or blazing the trails!

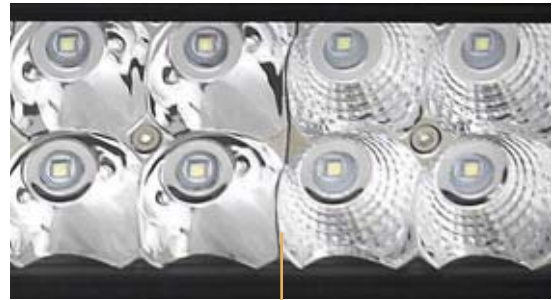

Product image / Dimensions	Features
----------------------------	----------

12 LED SPORT SERIES - 8"



The double row reflector gives this SPORT SERIES its modern look and great light performance. 1 year warranty.

Voltage	10-30 VDC
Light pattern:	Flood Beam
Light source:	LED
Power consumption:	36 Watt
Color temperature:	6000 Kelvin
Housing material:	Aluminum
Connection:	Wire leads
Mounting:	Stainless steel bracket
Dimensions	8.1" x 3.0" x 3.4" / 206 x 78 x 86 mm (WxHxD)
Approvals:	IP67
Part Number	357208001 Black housing 357208011 White housing

40 LED SPORT SERIES - 22"

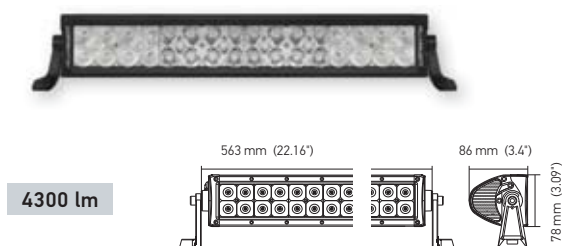

The double row reflector gives this SPORT SERIES its modern look and great light performance. The combination of Flood and Spot reflectors creates a far and wide illumination for maximum visibility at night. 1 year warranty.

Voltage	10-30 VDC
Light pattern:	Combo Beam
Light source:	LED
Power consumption:	120 Watt
Color temperature:	6000 Kelvin
Housing material:	Aluminum
Connection:	Wire leads
Mounting:	Stainless steel bracket
Dimensions	22.1" x 3.1" x 3.4" / 558 x 78 x 86 mm (WxHxD)
Approvals:	IP67
Part Number	357208101 Combo beam

HELLA VALUEFIT DESIGN SERIES

- 1 Combo Beam.** A combination of a spot beam and flood beam
- 2 Diecast Aluminum Housing** able to withstand the elements.
- 3 Aluminum Alloy Brackets** for sturdy upright mounting. A perfect fit for roof, grille and bumper mounting.
- 4 Sleek low profile design** for a discreet lighting solution!



Product image / Dimensions	Features
----------------------------	----------

6 LED DESIGN SERIES - 11"

The round reflectors give the DESIGN SERIES the unique appearance. The combination of Flood and Spot reflectors creates a far and wide illumination for maximum visibility at night. 1 year warranty.

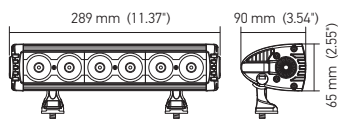

3000 lm

Voltage	10-30 VDC
Light pattern:	Combo Beam
Light source:	LED
Power consumption:	60 Watt
Color temperature:	6000 Kelvin
Housing material:	Aluminum
Connection:	Wire leads
Mounting:	Stainless steel bracket
Dimensions	11.4" x 2.6" x 3.5" / 289 x 65 x 90 mm (WxHxD)
Approvals:	IP67
Part Number	357209001 Combo beam

HELLA VALUEFIT WORKLIGHTS

The all-new worklight generation

Check out our new high performance worklights with innovative position light, and powerful light output.

NEW!



Product image / Dimensions	Features
----------------------------	----------

R2100 LED
Close Range

LED

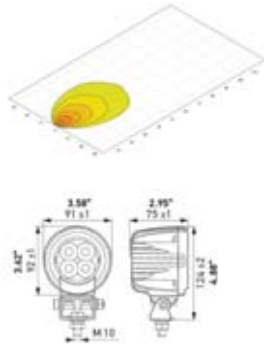

With this HELLA ValueFit work lamp series, a powerful and versatile lighting series has been developed to meet the requirements of diverse working environments..
2 year warranty.

Voltage	10 – 48 VDC
Light output (measured):	2,100 Lumen
Power consumption:	21 Watt
Color temperature:	6,000 Kelvin
Housing material:	Aluminum
Connection:	30" (800mm) cable with DT connector
Mounting:	Stainless steel bracket
Approvals:	CE, ECE-R10, ECE-R148, ECE-R86, IP6K7, IP6K9
Part Number	357109101 Close Range

2100 lm

R2100 LED 2.0
Close Range with PO

LED

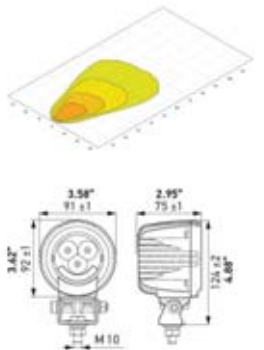

The HELLA ValueFit work light R2100 2.0 with an additional position light function that can be fitted with either a white or amber position light.
2 year warranty.

Voltage	10 – 48 VDC
Light output (measured):	2,100 Lumen
Power consumption:	29 Watt
Color temperature:	6,000 Kelvin
Housing material:	Aluminum
Connection:	11.8" (300mm) cable with DT connector
Mounting:	Stainless steel bracket
Approvals:	CE, ECE-R10, ECE-R148, ECE-R86, IP6K7, IP6K9
Part Number	357109111 Close Range with white or amber position light

2100 lm

S3000 LED
Close Range

LED

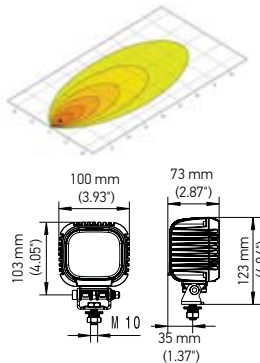

Perfect close range illumination to generate daylight working conditions at night
Designed for applications at the highest lighting requirements. Powerful compact LED worklight - 1 light can replace up to 3 halogen worklights. Integrated DT connector for safe and perfectly sealed electrical connection. 2 year warranty.

Voltage	10 – 52 VDC
Light output (measured):	3,000 Lumen
Power consumption:	31 Watt
Color temperature:	6000 Kelvin / 1800 Kelvin amber version
Housing material:	Aluminum
Connection:	30" (800mm) cable with DT connector
Mounting:	Stainless steel bracket
Approvals:	CE, ECE-R10, IP6K7, IP6K9
Part Number	357109002 Close Range 357109022 Close Range, amber

3000 lm

S3000 LED
Long Range

LED

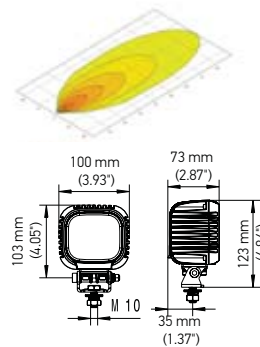

Perfect close range illumination to generate daylight working conditions at night
Designed for applications at the highest lighting requirements. Powerful compact LED worklight - 1 light can replace up to 3 halogen worklights. Integrated DT connector for safe and perfectly sealed electrical connection. 2 year warranty.

Voltage	10 – 52 VDC
Light output (measured):	3,400 Lumen
Power consumption:	31 Watt
Color temperature:	6000 Kelvin
Housing material:	Aluminum
Connection:	30" (800mm) cable with DT connector
Mounting:	Stainless steel bracket
Approvals:	CE, ECE-R10, IP6K7, IP6K9
Part Number	357109012 Long Range

3000 lm

S3000 LED 2.0
Close Range with PO

LED

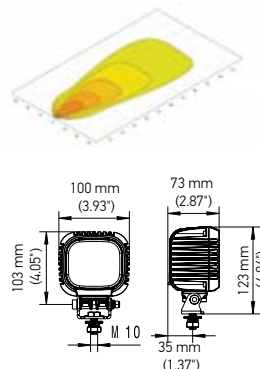

Powerful HELLA ValueFit worklight with an additional position light function that can be fitted with either a white or amber position light. Under cold working conditions the light output increases for an even better performance. Heavy Duty bracket for high impact resistance. Black stainless steel mounting hardware. 2 year warranty.

Voltage	10 – 30 VDC
Light output (measured):	3,000 Lumen
Power consumption:	38 Watt
Color temperature:	6,000 Kelvin
Housing material:	Aluminum with black stainless steel mounting bracket
Connection:	11.8" (300mm) cable with open wire leads
Approvals:	CE, ECE-R10, ECE R148, ECE R86 IP6K7, IP6K9
Part Number	357109031 Close Range with white or amber position light

3000 lm

Product image / Dimensions	Features
----------------------------	----------

S3000 LED 2.0
Long Range with PO



3000 lm

LED

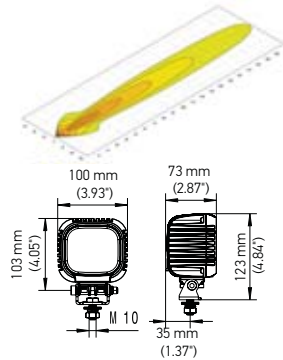

Powerful HELLA ValueFit worklight with an additional position light function that can be fitted with either a white or amber position light. Under cold working conditions the light output increases for an even better performance. Heavy Duty bracket for high impact resistance. Black stainless steel mounting hardware. 2 year warranty.

Voltage	10 – 30 VDC
Light output (measured):	3,000 Lumen
Power consumption:	38 Watt
Color temperature:	6,000 Kelvin
Housing material:	Aluminum with black stainless steel mounting bracket
Connection:	11.8" (300mm) cable with open wire leads
Approvals:	CE, ECE-R10, ECE R148, ECE R86 IP6K7, IP6K9
Part Number	357109041 Long Range with white or amber position light

S5000 LED
Short Range



5000 lm

LED

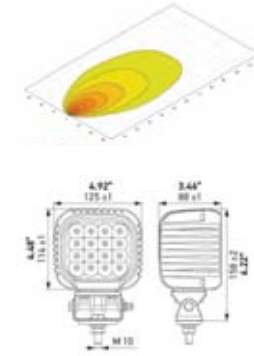

The most powerful LED worklight in this size. Active Thermo Management to prevent overheating and ensures a long lifetime. Under cold working conditions the light output increases for an even better performance. Stainless steel mounting hardware. 2 year warranty.

Voltage	10 – 48 VDC
Light output (measured):	5,000 Lumen
Power consumption:	47 Watt
Color temperature:	6,000 Kelvin
Housing material:	Aluminum
Connection:	30" (800mm) cable with DT connector
Mounting:	Aluminum with black stainless steel mounting bracket
Approvals:	CE, ECE-R10, IP6K7, IP6K9
Part Number	357109201 Close Range

S5000 LED
Long Range



5000 lm

LED

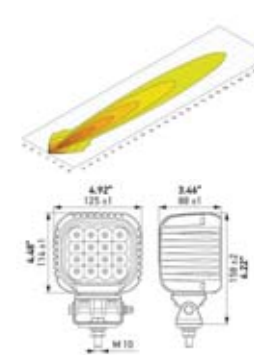

The most powerful LED worklight in this size. Active Thermo Management to prevent overheating and ensures a long lifetime. Under cold working conditions the light output increases for an even better performance. Stainless steel mounting hardware. 2 year warranty.

Voltage	10 – 48 VDC
Light output (measured):	5,000 Lumen
Power consumption:	47 Watt
Color temperature:	6,000 Kelvin
Housing material:	Aluminum
Connection:	30" (800mm) cable with DT connector
Mounting:	Black stainless steel bracket
Approvals:	CE, ECE-R10, IP6K7, IP6K9
Part Number	357109211 Long Range

S5000 LED 2.0
Short Range with PO



5000 lm

LED

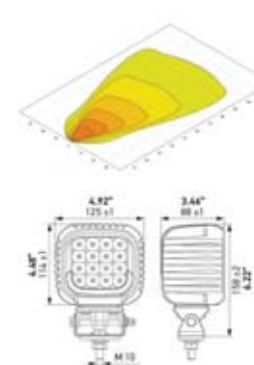

The all-new LED worklight with white or amber position light. The lens is made from special plastic, the housing from lightweight yet robust aluminium and the bracket is crafted from corrosion-resistant stainless steel in order to ensure a long service life. 2 year warranty.

Voltage	10 – 30 VDC
Light output (measured):	5,000 Lumen
Power consumption:	66 Watt
Color temperature:	6,000 Kelvin
Housing material:	Aluminum
Connection:	11.8" (300mm) cable with open wire leads
Mounting:	Black stainless steel bracket
Approvals:	CE, ECE-R10, ECE R148, ECE R86 IP6K7, IP6K9
Part Number	357109221 Short Range

S5000 LED 2.0
Long Range with PO



5000 lm

LED

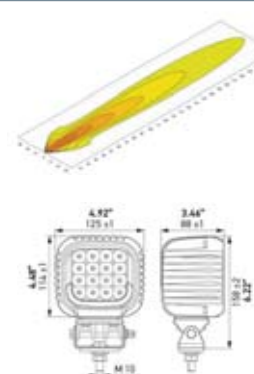

The all-new LED worklight with white or amber position light. The lens is made from special plastic, the housing from lightweight yet robust aluminium and the bracket is crafted from corrosion-resistant stainless steel in order to ensure a long service life. 2 year warranty.

Voltage	10 – 30 VDC
Light output (measured):	5,000 Lumen
Power consumption:	66 Watt
Color temperature:	6,000 Kelvin
Housing material:	Aluminum
Connection:	11.8" (300mm) cable with open wire leads
Mounting:	Black stainless steel bracket
Approvals:	CE, ECE-R10, ECE R148, ECE R86 IP6K7, IP6K9
Part Number	357109231 Long Range

Product image / Dimensions	Features
----------------------------	----------

PS1000 LED

LED



1000 lm

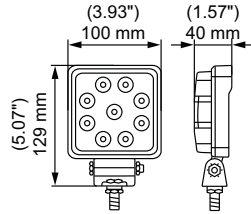

Latest LED technology. Thin plastic housing for 100% corrosion resistance. Lightweight - high vibration resistance. Black stainless steel mounting hardware. 2 year warranty.

Voltage	10 – 30 VDC
Light output (measured):	1,000 Lumen
Power consumption:	9 Watt
Color temperature:	6,500 Kelvin
Housing material:	Thermoplastic
Connection:	30" (800mm) cable with open wires
Mounting:	Black stainless steel bracket
Approvals:	CE, ECE-R10, IP67, IP6K9K (withstands high pressure cleaning)
Part Number	357114002 Close Range

TS1700 LED

LED



1700 lm

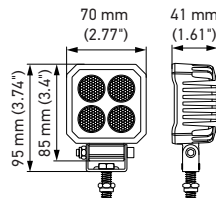

Most powerful LED worklight in this size. Active Thermo Management to prevent overheating and ensures a long lifetime. Under cold working conditions the light output increases for an even better performance. Super compact size - just 3x3". Black stainless steel mounting hardware. 2 year warranty.

Voltage	10 – 30 VDC
Light output (measured):	1,700 Lumen
Power consumption:	24 Watt
Color temperature:	5,700 Kelvin
Housing material:	Aluminum
Connection:	30" (800mm) cable with open wires
Mounting:	Black stainless steel bracket
Approvals:	CE, ECE-R10, IP67, IP6K9K (withstands high pressure cleaning)
Part Number	357110002 Close Range

TR1700 LED

LED



1700 lm

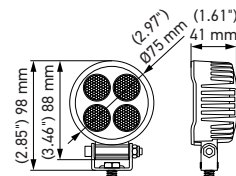

Most powerful LED worklight in this size. Active Thermo Management to prevent overheating and ensures a long lifetime. Under cold working conditions the light output increases for an even better performance. Super compact size - just 3x3". Black stainless steel mounting hardware. 2 year warranty.

Voltage	10 – 30 VDC
Light output (measured):	1,700 Lumen
Power consumption:	24 Watt
Color temperature:	5,700 Kelvin
Housing material:	Aluminum
Connection:	30" (800mm) cable with open wires
Mounting:	Black stainless steel bracket
Approvals:	CE, ECE-R10, IP67, IP6K9K (withstands high pressure cleaning)
Part Number	357111002 Close Range

TS3000 LED

LED



3000 lm

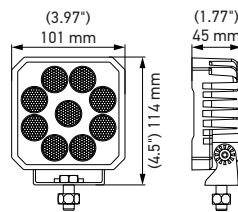

Most powerful HELLA ValueFit worklight. Active Thermo Management to prevent overheating. Under cold working conditions the light output increases for an even better performance (up to 4,000 lm). Heavy Duty bracket for high impact resistance. Black stainless steel mounting hardware. 2 year warranty.

Voltage	10 – 30 VDC
Light output (measured):	3,000 Lumen
Power consumption:	31 Watt
Color temperature:	5,700 Kelvin
Housing material:	Aluminum
Connection:	30" (800mm) cable with open wires
Mounting:	Black stainless steel bracket
Approvals:	CE, ECE-R10, IP67, IP6K9K (withstands high pressure cleaning)
Part Number	357112002 Close Range

TR3000 LED

LED



3000 lm

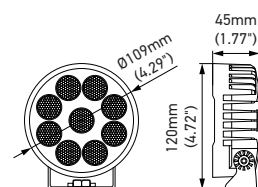

Most powerful HELLA ValueFit worklight. Active Thermo Management to prevent overheating. Under cold working conditions the light output increases for an even better performance (up to 4,000 lm). Heavy Duty bracket for high impact resistance. Black stainless steel mounting hardware. 2 year warranty.

Voltage	10 – 30 VDC
Light output (measured):	3,000 Lumen
Power consumption:	31 Watt
Color temperature:	5,700 Kelvin
Housing material:	Aluminum with black stainless steel mounting bracket
Connection:	30" (800mm) cable with open wire leads
Approvals:	CE, ECE-R10, IP67, IP6K9K (withstands high pressure cleaning)
Part Number	357113002 Close Range

Product image / Dimensions	Features
----------------------------	----------

PS1000 LED

LED



1000 lm

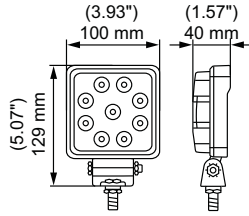

Latest LED technology. Thin plastic housing for 100% corrosion resistance. Lightweight - high vibration resistance. Black stainless steel mounting hardware. 2 year warranty.

Voltage	10 – 30 VDC
Light output (measured):	1,000 Lumen
Power consumption:	9 Watt
Color temperature:	6,500 Kelvin
Housing material:	Thermoplastic
Connection:	30" (800mm) cable with open wires
Mounting:	Black stainless steel bracket
Approvals:	CE, ECE-R10, IP67, IP6K9K (withstands high pressure cleaning)
Part Number	357114002 Close Range

TS1700 LED

LED



1700 lm

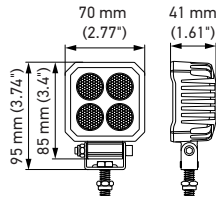

Most powerful LED worklight in this size. Active Thermo Management to prevent overheating and ensures a long lifetime. Under cold working conditions the light output increases for an even better performance. Super compact size - just 3x3". Black stainless steel mounting hardware. 2 year warranty.

Voltage	10 – 30 VDC
Light output (measured):	1,700 Lumen
Power consumption:	24 Watt
Color temperature:	5,700 Kelvin
Housing material:	Aluminum
Connection:	30" (800mm) cable with open wires
Mounting:	Black stainless steel bracket
Approvals:	CE, ECE-R10, IP67, IP6K9K (withstands high pressure cleaning)
Part Number	357110002 Close Range

TR1700 LED

LED



1700 lm

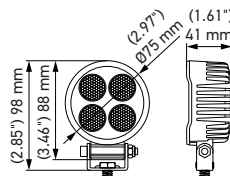

Most powerful LED worklight in this size. Active Thermo Management to prevent overheating and ensures a long lifetime. Under cold working conditions the light output increases for an even better performance. Super compact size - just 3x3". Black stainless steel mounting hardware. 2 year warranty.

Voltage	10 – 30 VDC
Light output (measured):	1,700 Lumen
Power consumption:	24 Watt
Color temperature:	5,700 Kelvin
Housing material:	Aluminum
Connection:	30" (800mm) cable with open wires
Mounting:	Black stainless steel bracket
Approvals:	CE, ECE-R10, IP67, IP6K9K (withstands high pressure cleaning)
Part Number	357111002 Close Range

TS3000 LED

LED



3000 lm

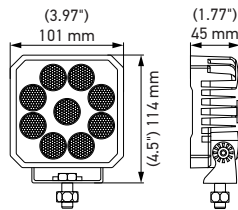

Most powerful HELLA ValueFit worklight. Active Thermo Management to prevent overheating. Under cold working conditions the light output increases for an even better performance (up to 4,000 lm). Heavy Duty bracket for high impact resistance. Black stainless steel mounting hardware. 2 year warranty.

Voltage	10 – 30 VDC
Light output (measured):	3,000 Lumen
Power consumption:	31 Watt
Color temperature:	5,700 Kelvin
Housing material:	Aluminum
Connection:	30" (800mm) cable with open wires
Mounting:	Black stainless steel bracket
Approvals:	CE, ECE-R10, IP67, IP6K9K (withstands high pressure cleaning)
Part Number	357112002 Close Range

TR3000 LED

LED



3000 lm

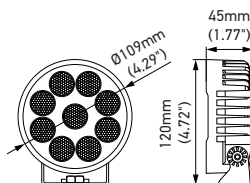

Most powerful HELLA ValueFit worklight. Active Thermo Management to prevent overheating. Under cold working conditions the light output increases for an even better performance (up to 4,000 lm). Heavy Duty bracket for high impact resistance. Black stainless steel mounting hardware. 2 year warranty.

Voltage	10 – 30 VDC
Light output (measured):	3,000 Lumen
Power consumption:	31 Watt
Color temperature:	5,700 Kelvin
Housing material:	Aluminum with black stainless steel mounting bracket
Connection:	30" (800mm) cable with open wire leads
Approvals:	CE, ECE-R10, IP67, IP6K9K (withstands high pressure cleaning)
Part Number	357113002 Close Range

Product image / Dimensions	Features
----------------------------	----------

MASTER 1400 LED

LED

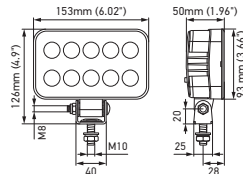

1350 lm

The new technological generation of the popular, rectangular master work lamp series for converting to LED with corrosion-free plastic housing in slim design without edges Available in two different bracket versions. Straight-forward and convenient mounting thanks to square hole in bracket. Robust and vibration-reducing mounting Integrated DT connector for safe and perfectly sealed electrical connection. 2 year warranty.

Voltage	12 VDC / 24 VDC
Light output (measured):	1,350 Lumen
Power consumption:	18 Watt
Color temperature:	6500 Kelvin
Housing material:	Corrosion-free plastic housing
Connection:	500 mm cable with open end
Mounting:	Stainless steel bracket
Approvals:	ECE-R10, UKCA, ADR / GGVSEB, IP 6K7, IP 6K9K (withstands high pressure cleaning)
Part Number	357877001 Close Range, with short mounting bracket

5RD LED 2.0

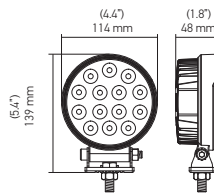
LED



2000 lm

Powerful LED worklight. Flat and compact design. Also available in amber for winter or foggy environments Stainless steel mounting hardware. 1 year warranty.

Voltage	10 - 30 VDC
Light output (measured):	2000 Lumen / 1700 Lumen amber version
Power consumption:	24 Watt
Color temperature:	6000 Kelvin / 2500 Kelvin amber version
Housing material:	Aluminum
Connection:	20" (500mm) cable with open wires
Mounting:	Stainless steel bracket
Approvals:	CE, ECE-R10, IP67, IP6K9K (withstands high pressure cleaning)
Part Number	357105002 Close Range 357105012 Long Range 358115371 (357106012AMB) Close Range, amber

5RD LED 1.0

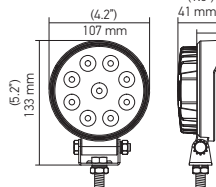
LED



1000 lm

Favorite LED worklight in size and shape. Flat and round design (4" diameter) Stainless steel mounting hardware. 1 year warranty.

Voltage	10 - 30 VDC
Light output (measured):	1000 Lumen
Power consumption:	15 Watt
Color temperature:	6000 Kelvin
Housing material:	Aluminum
Connection:	20" (500mm) cable with open wires
Mounting:	Stainless steel bracket
Approvals:	CE, ECE-R10, IP67, IP6K9K (withstands high pressure cleaning)
Part Number	357101002 Close Range 357100002 Long Range

5RD LED

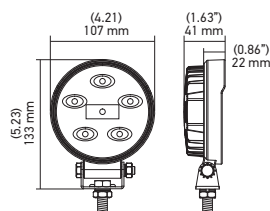
LED

700 lm

Perfect entry level worklight for a switch from halogen to LED. Flat and square design (4x4"), Stainless steel mounting hardware. 1 year warranty.

Voltage	10 - 30 VDC
Light output (measured):	700 Lumen
Power consumption:	9 Watt
Color temperature:	6000 Kelvin
Housing material:	Aluminum
Connection:	20" (500mm) cable with open wires
Mounting:	Stainless steel bracket
Approvals:	CE, ECE-R10, IP67, IP6K9K (withstands high pressure cleaning)
Part Number	357108001 Close Range

Product image / Dimensions	Features
----------------------------	----------

4SQ LED 2.0

LED

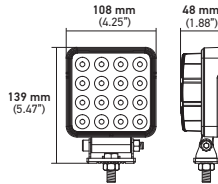

2000 lm

Powerful LED worklight in suitable size. Also available with a magnet, switch and handle
Stainless steel mounting hardware. 1 year warranty.

Voltage	10 - 30 VDC
Light output (measured):	2000 Lumen
Power consumption:	24 Watt
Color temperature:	6000 Kelvin
Housing material:	Aluminum
Connection:	20" (500mm) cable with open wires
Mounting:	Stainless steel bracket
Approvals:	CE, ECE-R10, IP67, IP6K9K (withstands high pressure cleaning)

Part Number	357106002 Close Range
	357106012 Long Range

4SQ LED 1.0

LED

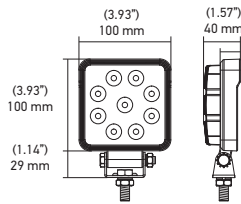

1000 lm

Favorite LED worklight in size and shape. Flat and square design (4x4)
Also available with a handle and switch. Stainless steel mounting hardware. 1 year warranty.

Voltage	10 - 30 VDC
Light output (measured):	1000 Lumen
Power consumption:	15 Watt
Color temperature:	6000 Kelvin
Housing material:	Aluminum
Connection:	20" (500mm) cable with open wires
Mounting:	Stainless steel bracket
Approvals:	CE, ECE-R10, IP67, IP6K9K (withstands high pressure cleaning)

Part Number	357103002 Close Range
	357102002 Long Range

4SQ LED

LED

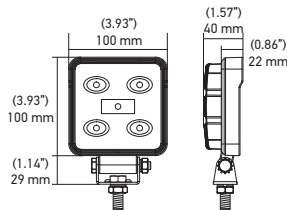

700 lm

Perfect entry level worklight for a switch from halogen to LED.
Flat and square design (4x4). Stainless steel mounting hardware. 1 year warranty.

Voltage	10 - 30 VDC
Light output (measured):	700 Lumen
Power consumption:	9 Watt
Color temperature:	6000 Kelvin
Housing material:	Aluminum
Connection:	20" (500mm) cable with open wires
Mounting:	Stainless steel bracket
Approvals:	CE, ECE-R10, IP67, IP6K9K (withstands high pressure cleaning)

Part Number	357107001 Close Range
--------------------	------------------------------

RC 360 GEN. 2

LED

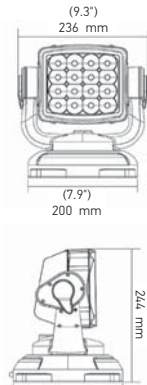
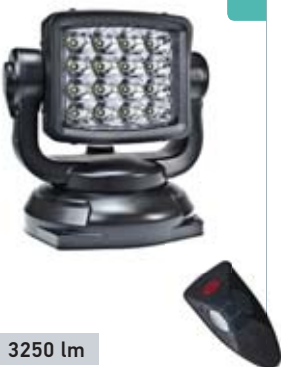

3250 lm

Remote controlled LED searchlight
Vertical rotation: 110 degree, horizontal rotation: 360 degree
Flash function: SOS Distress Signal (3 long flash - 2 short flash)
Remote control and batteries included
1 year warranty.

Voltage	10 - 30 VDC
Light output (measured):	3250 Lumen
Power consumption:	80 Watt
Color temperature:	6500 Kelvin
Housing material:	Aluminum
Connection:	15 ft cable with cigarette lighter plug
Mounting:	Magnet or fixed mounting (upright only)
Approvals:	IP67

Part Number	357104041 Spot light, Black housing
	357104051 Spot light, White housing

Product image / Dimensions	Features
----------------------------	----------

2 LED BLUE

300 lm

LED



Great optical warning effect to increase work safety. Provides visual blue warning signal for pedestrians. 2 LEDs project the blue light beam spot within 3-5 meters in front of the vehicle. Designed for forklifts. 1 year warranty.

Voltage	10 - 80 VDC
Light output (measured):	300 Lumen
Power consumption:	6 Watt
Color temperature:	9000 Kelvin
Housing material:	Aluminum
Connection:	20" (500mm) cable with open wires
Mounting:	Stainless steel bracket
Approvals:	CE, ECE-R10, IP67, IP6K9K (withstands high pressure cleaning)
Part Number	530040329 (H71030181) Warning Spot, Blue

SL60 LED

LED

- Super compact LED warning stripe to improve the safety at work
- Projection: Blue or red stripe-shaped warning line to the ground
- Powerful light output for visibility even under daylight conditions
- Compact design is well-suited when little installation space is available
- 2 year warranty

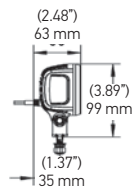
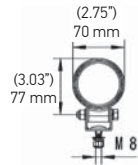

- Voltage: 10-80 VDC
- Power Consumption: max. 7 Watt
- Colors: Blue, Red
- Housing Material: Aluminum
- Connection: 20 " cable with open wires
- Mounting: Stainless Steel Bracket
- Approvals: CE, ECE-R10, IP6K9K (withstands high pressure cleaning)

996210001 Blue

996210011 Red

Contains:

- 1 LED Light
- Mounting instructions and installation components



Product image / Dimensions	Features
----------------------------	----------

WIRE HARNESS FOR SINGLE LIGHT



Perfect for HELLA ValueFit auxiliary lights and lightbars
For single light - up to 300 W of power
Relay, switch and fuse included

Voltage:	12 VDC
Power:	Up to 300 W
Connection:	ATP Connector
Contains:	1 x 10 ft cable, 1 x 18" fuse cable, 1 x 6.4 ft switch cable
Part Number	357211001

WIRE HARNESS FOR TWO LIGHTS



Wire Harness for Two Lights

Perfect for HELLA ValueFit auxiliary lights and lightbars
For two lights - up to 300 W of power
Relay, switch and fuse included

Voltage:	12 VDC
Power:	Up to 300 W
Connection:	DT Connectors
Contains:	2 x 10 ft cable, 1 x 18" fuse cable, 1 x 6.4 ft switch cable
Part Number	357211011

DISPLAYS:

Product displays are the number one sales tool to highlight new products and get the immediate attention of the customers. Having a well designed product displays helps to explain the products and will have a positive effect on the sales success. Our displays are fully assembled, completely wired, using high quality On/Off switches and a 110 V power supply.

HELLA VALUEFIT AUXILIARY LIGHT DISPLAY



Products	(1) HELLA VALUEFIT 450 LED (1) HELLA VALUEFIT 500 LED and amber stone shield
Dimensions	20" x 4" x 5.9" / 510 x 102 x 150 mm (WxHxD)
Part Number	358117201

HELLA VALUEFIT WORKLIGHT DISPLAY



Content	(1) HELLA VALUEFIT PS1000 (1) HELLA VALUEFIT TR1700 (1) HELLA VALUEFIT TS3000
Dimensions	17.7" x 4.7" x 6.3" / 450 x 120 x 160 mm (WxHxD)
N° de Parte	999942107

HELLA VALUEFIT HAND LAMPS

- Rechargeable hand lamps with micro USB cable
- Compact design for universal applications
- Choose from different light intensities
- Multifunctional use and magnetic attachment

NEW!

HELLA VALUEFIT hand lamps

The new HELLA VALUEFIT hand lamp range offers five handy and rechargeable lamps for workshop, leisure and DIY applications. In addition, a bonnet lamp with a powerful 1,000 lumen light output is available, which can be used in bonnets with a width of 120 to 200 cm using telescopic mounting.

These multifunctional lamps can be used quickly and flexibly wherever additional light is required for repair or inspection work.



Product image / Dimensions	Features																		
<p>USP300</p>  <p style="writing-mode: vertical-rl; transform: rotate(180deg);">LED</p>  	<p>USB Slim Pocket Light. Slim hand lamp with a 270° foldable lamp body. The metal hook or the strong magnet on the underside of the lamp can be used for fastening. Power supply via micro USB cable</p> <table border="1"> <tr> <td>Floodlight (main light)</td> <td>3 W COB-LED</td> </tr> <tr> <td>Torch function (spotlight)</td> <td>1 W LED</td> </tr> <tr> <td>Light mode/light output</td> <td>Main light (COB LED): 150 lm (level 1), 300 lm (level 2)</td> </tr> <tr> <td>Charging time in hours</td> <td>Max. 4 h</td> </tr> <tr> <td>Operating time in hours</td> <td>4 h (main light, level 1), 2.5 h (main light, level 2), 6 h (torch function)</td> </tr> <tr> <td>Battery included</td> <td>3.7 V/2,000 mAh Li-Ion</td> </tr> <tr> <td>Magnet</td> <td>Yes</td> </tr> <tr> <td>Additional mounting</td> <td>Hook</td> </tr> <tr> <td>Part Number</td> <td>357300001</td> </tr> </table>	Floodlight (main light)	3 W COB-LED	Torch function (spotlight)	1 W LED	Light mode/light output	Main light (COB LED): 150 lm (level 1), 300 lm (level 2)	Charging time in hours	Max. 4 h	Operating time in hours	4 h (main light, level 1), 2.5 h (main light, level 2), 6 h (torch function)	Battery included	3.7 V/2,000 mAh Li-Ion	Magnet	Yes	Additional mounting	Hook	Part Number	357300001
Floodlight (main light)	3 W COB-LED																		
Torch function (spotlight)	1 W LED																		
Light mode/light output	Main light (COB LED): 150 lm (level 1), 300 lm (level 2)																		
Charging time in hours	Max. 4 h																		
Operating time in hours	4 h (main light, level 1), 2.5 h (main light, level 2), 6 h (torch function)																		
Battery included	3.7 V/2,000 mAh Li-Ion																		
Magnet	Yes																		
Additional mounting	Hook																		
Part Number	357300001																		
<p>UPL150</p>  <p style="writing-mode: vertical-rl; transform: rotate(180deg);">LED</p>  	<p>USB Pen Light Light and compact hand lamp in the shape of a pen. The pocket clip can be rotated 180° and is also equipped with a magnet.</p> <table border="1"> <tr> <td>Floodlight (main light)</td> <td>2 W</td> </tr> <tr> <td>Torch function (spotlight)</td> <td>1 W LED</td> </tr> <tr> <td>Light mode/light output</td> <td>Main light (COB LED): 150 lm</td> </tr> <tr> <td>Charging time in hours</td> <td>1.5 h</td> </tr> <tr> <td>Operating time in hours</td> <td>3 h (main light), 4 h (torch function)</td> </tr> <tr> <td>Battery included</td> <td>3.7 V/800 mAh Li-Ion</td> </tr> <tr> <td>Magnet</td> <td>Yes</td> </tr> <tr> <td>Additional mounting</td> <td>Rotating clip</td> </tr> <tr> <td>Part Number</td> <td>357300101</td> </tr> </table>	Floodlight (main light)	2 W	Torch function (spotlight)	1 W LED	Light mode/light output	Main light (COB LED): 150 lm	Charging time in hours	1.5 h	Operating time in hours	3 h (main light), 4 h (torch function)	Battery included	3.7 V/800 mAh Li-Ion	Magnet	Yes	Additional mounting	Rotating clip	Part Number	357300101
Floodlight (main light)	2 W																		
Torch function (spotlight)	1 W LED																		
Light mode/light output	Main light (COB LED): 150 lm																		
Charging time in hours	1.5 h																		
Operating time in hours	3 h (main light), 4 h (torch function)																		
Battery included	3.7 V/800 mAh Li-Ion																		
Magnet	Yes																		
Additional mounting	Rotating clip																		
Part Number	357300101																		
<p>USL300</p>  <p style="writing-mode: vertical-rl; transform: rotate(180deg);">LED</p>   	<p>USB stick lamp Very slim rod lamp for illuminating very narrow areas. The lamp is equipped with a base that swivels 180°. Plus, hook and magnet for flexible handling.</p> <table border="1"> <tr> <td>Floodlight (main light)</td> <td>3 W COB-LED</td> </tr> <tr> <td>Torch function (spotlight)</td> <td>2 x 0.2 W LED</td> </tr> <tr> <td>Light mode/light output</td> <td>Main light (COB LED): 150 lm (level 1), 300 lm (level 2) Lamp function: 20 lm</td> </tr> <tr> <td>Charging time in hours</td> <td>Max. 4 h</td> </tr> <tr> <td>Operating time in hours</td> <td>5 h (main light, level 1), 3 h (main light level 2), 7 h torch function</td> </tr> <tr> <td>Battery included</td> <td>3.7 V / 2,000 mAh Li-Ion</td> </tr> <tr> <td>Magnet</td> <td>Yes</td> </tr> <tr> <td>Additional mounting</td> <td>Hook</td> </tr> <tr> <td>Part Number</td> <td>357300201</td> </tr> </table>	Floodlight (main light)	3 W COB-LED	Torch function (spotlight)	2 x 0.2 W LED	Light mode/light output	Main light (COB LED): 150 lm (level 1), 300 lm (level 2) Lamp function: 20 lm	Charging time in hours	Max. 4 h	Operating time in hours	5 h (main light, level 1), 3 h (main light level 2), 7 h torch function	Battery included	3.7 V / 2,000 mAh Li-Ion	Magnet	Yes	Additional mounting	Hook	Part Number	357300201
Floodlight (main light)	3 W COB-LED																		
Torch function (spotlight)	2 x 0.2 W LED																		
Light mode/light output	Main light (COB LED): 150 lm (level 1), 300 lm (level 2) Lamp function: 20 lm																		
Charging time in hours	Max. 4 h																		
Operating time in hours	5 h (main light, level 1), 3 h (main light level 2), 7 h torch function																		
Battery included	3.7 V / 2,000 mAh Li-Ion																		
Magnet	Yes																		
Additional mounting	Hook																		
Part Number	357300201																		

Product image / Dimensions	Features
----------------------------	----------

UBL1000

LED

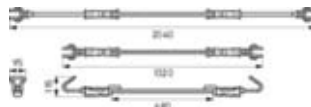

1. Strong, built-in magnets and 360° rotating hook. | 2. Practical micro USB charging socket for easy connection and charging of the battery. | 3. Extendable struts (120 to 200 cm).

USB bonnet lamp

The bonnet lamp with 1,000 lumen light output for safe work in the engine compartment. With 360° rotating hooks and magnets.

The two struts with two magnets each can be folded 90°. The lamp can be used on bonnets with a width of 120 to 200 cm using the extendable struts. Power supply via micro USB cable

Floodlight (main light)	40 SMD LED
Light mode/light output	Main light (SMD LED): 500 lm (level 1), 1,000 lm (level 2)
Charging time in hours	Max. 4 h
Operating time in hours	8 h (main light, level 1), 4 h (main light, level 2)
Battery included	3.7 V/4,000 mAh Li-Ion
Magnet	Yes
Additional mounting	Extendable mounting with hooks and magnets (120 – 200 cm)
Part Number	357300501

UHL280 AND UHL280 BASE

LED



1. The bracket can be swivelled through 180°. | 2. Strong, built-in magnets on the underside for attachment to suitable surfaces. | 3. Practical hook for easy mounting. | 4. Practical micro USB charging socket for easy connection and charging of the battery. | 5. Integrated spotlight function.

Rechargeable USB hand lamp

The practical holder can be rotated by 180°. There are hooks and magnets on the back and two additional magnets on the underside.

The UHL280 BASE variant is a USB rechargeable hand lamp with charging station.

Floodlight (main light)	3 W COB-LED
Torch function (spotlight)	1 W LED
Light mode/light output	Main light (COB LED): 150 lm (level 1), 280 lm (level 2)
Charging time in hours	Max. 4 h
Operating time in hours	3 h (main light, level 1), 2.5 h (main light, level 2), 7 h (torch function)
Battery included	3.7 V/2,000 mAh Li-Ion
Magnet	Yes
Additional mounting	Hook
Part Number	357300301 UHL280 357300311 UHL280 BASE

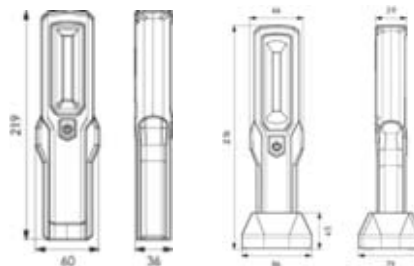



HELLA WORK LIGHTS

The perfect solution for any application scenario

Good lighting is a key tool in many work areas. That is why HELLA work lights should always be your first choice to: illuminate large areas when working in the field, optimal illumination of nearby or distant areas in construction sites or farms or in lighting of specific objects. A clearly visible work area will help you focus. LED, xenon and halogen technology allow you to steer heavy machines with precision even in the dark, a worthwhile investment.

We are not only manufacturers, we are also a customer-oriented service provider. As a retail partner, we provide a service that goes far beyond just products.

HELLA - Technology with vision!



MICROSITE: Find more information about HELLA and HELLA VALUEFIT at:



www.hellahd.com



HELLA solutions for more safety and comfort in your everyday working life

Vehicle lighting plays an important role in safety and workplace convenience. There are many situations where there is still room for improvement, especially when it comes to occupational safety. For example, it is important that hazard zones can be optically marked or demarcated at any time so that everyone in the affected area can be warned and protected in good time. Previously, this had to be done by the driver or by other workers, who would manually mark off the areas concerned. This meant that it was not possible to demarcate individual areas as required in a simple, swift and safe action. With the VISIOTECH projection technology, HELLA has brought products onto the market that are designed to help in these exact situations. However, oncoming traffic should not just be warned or alerted. It is also important that it is dazzled as little as possible in order to avoid accidents caused by glare and poor visibility. That is why HELLA has developed ZEROGLARE glare-free illumination that does not dazzle oncoming vehicles.



Compare traditional illumination (left) with **ZEROGLARE** illumination (right)



Glare-free **ZEROGLARE** illumination



Video clip – **ZEROGLARE**
Scan, watch and find out more.

ZEROGLARE technology for glare-free illumination

In order to transfer the same safety and convenience seen in the automotive sector to other target groups, HELLA has developed a new optical system for work lights. The **ZEROGLARE** system ensures that drivers in oncoming vehicles are not dazzled. Unlike the usual LED work lights, the cut-off line is very sharp and the light of the **ZEROGLARE** headlamp is directed specifically at the area in front of the vehicle. Several series are already available with this technology.



VISIOTECH technology application examples

VISIOTECH technology – Communicating with light

With the new VISIOTECH projection technology, HELLA allows you to communicate using light by projecting various symbols and illuminations onto the ground.

This warns other vehicles or pedestrians of an oncoming vehicle. The lines projected in front of the vehicle can also be used for easier vehicle navigation. Projecting symbols can also easily and safely mark work areas. This results in increased safety and convenience during the daily work routine.

Using products with VISIOTECH technology is permitted for applications outside the StVZO (German Road Traffic Regulations). Special approvals are required for special applications on the road.

Designed for the toughest working conditions!

Thanks to modern technologies developed using our OE know-how, HELLA work lights can withstand the most challenging environmental conditions. The headlamps' sophisticated thermal management and corrosion resistance in particular ensure a very long service life. After all, high-power illumination performance can only go unhindered if the heat can be optimally dissipated from the high-power LED headlamps. A long service life is guaranteed thanks to corrosion-resistant headlamps with special coatings or plastic housings. Go for the best quality and increase your working efficiency.



CoroSafe coating for work lights with an aluminium housing



NanoSafe coating for work lights with an aluminium housing for particularly tough applications such as mines

CoroSafe/NanoSafe

New process to combat corrosion in aluminium housings
With its new coating processes against corrosion, HELLA is once again setting standards in the durability and toughness of work lights with aluminium housings. Two additionally implemented layers in the surface coating of the work lights greatly improve their durability. The sophisticated combination of different coating methods ensures a high level of corrosion resistance and improved protection against work light damage. This means that the housing is well-protected and ideal for use in environments with large amounts of salt and water. CoroSafe is used primarily with HELLA LED reversing lights. When using the NanoSafe coating for special applications, such as mines, an additional coating is applied. This protects against corrosion in particularly tough applications.



Videoclip - CoroSafe and Thermo Pro
Scan, watch now and find out more.



Innovative heat-conducting plastic housing to combat corrosion

Compact series

Corrosion-free and lighter plastic housing
The innovative plastic housing of the Compact series boasts similar thermal conductivity properties to aluminium. This allows the LEDs to operate using the full power supply even at high ambient temperatures. Thanks to the housing's innovative plastic material, corrosion is averted and a long service life is guaranteed. In addition, the Compact scores points with its considerably reduced weight and improved vibration characteristics.

IP protection classes

Features and descriptions

What does IP protection class mean?

IP stands for International Protection. The IP protection classes are determined according to DIN 40 050, Part 9. The purpose of the norm is to provide an exact definition of the electrical equipment of vehicles against the ingress of solid foreign objects including dust, and against the ingress of water. The varying degrees of protection important for signalling systems are explained in more detail below.

Protection class IP 5K4K

Dust may only penetrate to such an extent that the function and safety are not impaired. Water that is sprayed against the housing from every direction at increased pressure must not have any damaging effect.: the water pressure is approx. 4 bar.

Protection class IP 9K

Water that is directed from high-pressure/steam-cleaning equipment onto the housing must not have any damaging effect: the water pressure is approx. 80-100 bar.

Protection class IP 6K7/IP 6K8

Dust must not penetrate. Even during temporary (IP 6K7) or permanent (IP 6K8) submersion, no water is allowed to penetrate. HELLA products meet the highest requirements and are optimally protected against all weather conditions.

Product image / Dimensions	Features
----------------------------	----------

HYPALUME



LED

- Developed specifically for mining and lighting tower applications
- Highly efficient light distribution
- Powerful LEDs illuminate the surrounding area for daylight working conditions
- Close Range, long range and extra wide illumination options
- Different versions from 24 VDC up to 240 VAC available
- Thermal management
- 5 year warranty

Features

- Light output (measured): 28,000 lumen
- Power requirement: 300 Watt
- Color temperature: 5,700 Kelvin
- Housing Material: Aluminum
- Protection: Reverse polarity, transient spike circuit protection
- > 60 VDC over-voltage protection
- Connection: 4 pin DT connector
- Mounting: Heavy Duty Stainless Steel Bracket
- Approvals: RCM, FCC, CE, IP6K7, IP 6K9K (withstands high pressure cleaning)
- Soft Start at PIN3
- 5 Dimming levels at PIN 4
- Non-stick and easy to clean surface coating
- High impact Grilamid nylon lens,
- 50 G Heavy Duty stainless steel bracket
- Mounting standing / hanging.

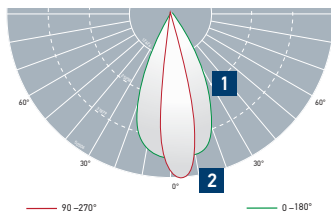
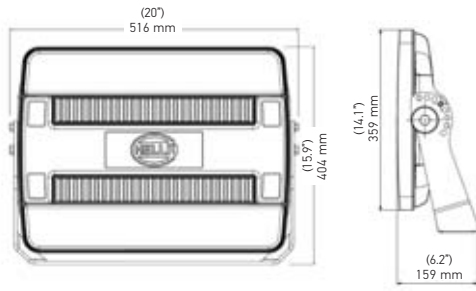

- 1** CR: Close Range
- 2** LR: Long Range
- 3** XW: Extra Wide Flood

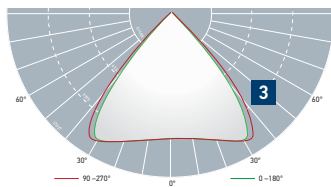

48 V	HypaLUME 48V RFCCommSafe	
	Close Range	011872221
	Long Range	011872231*

24-48 V	HypaLUME Multi-voltage 24 - 48 VCD	
	Close Range	011872501
	Long Range	011872511*
	Extra Wide	011872521*

Accessories

AC/DC Converter 320 W 24 V	358116681
AC/DC Converter 320 W 48 V	358116171
AC/DC Converter 300 W 480 VAC - 24 VCD	358116701

100-240 V AC	HypaLUME 100-240 V AC	
	Close Range	958334011
	Long Range	958334021*
	Extra Wide	958334031*

*Special order item



ZEROGLARE

Bringing Onroad Safety to Mining

HELLA Mining has developed the **ZEROGLARE** optical system to bring the safety and comfort of highway driving to mining operations! The **ZEROGLARE** optical system ensures no light from oncoming traffic will be directed into the eyes of oncoming drivers eliminating the occurrence of discomfort or disability glare. The innovative optical system has a sharp horizontal cut off to control the light onto the ground in front of the vehicle and not into oncoming operators field of vision.



The **ZEROGLARE** optical system ensures all emitted light is directed below the horizontal plane



With **ZEROGLARE**

Scan for Video on ZEROGLARE



Product image / Dimensions	Features	Technical Specifications	Part Number
----------------------------	----------	--------------------------	-------------

RokLUME 380

LED

- Most powerful LED worklight in the HELLA range
 - Designed for the roughest mining conditions
 - Heavy Duty bracket for extra strong resistance to vibration
 - Aluminum housing is protected with a special NanoSafe (non-sticky and easy to clean surface) coating
 - ZEROGLARE option for non-glare illumination
 - DT counterpart included
 - 5 year warranty
- Voltage: 20-32 VDC
 - Light Output (measured): 8,000 lm
 - Power Consumption: 84 Watt
 - Color Temperature: 5,000 Kelvin
 - Housing Material: Aluminum
 - Lens Material: Hardcoated PC lens
 - Connection: DT connector
 - Mounting: Heavy Duty bracket
 - Approvals: IP6K8, IP6K9K (withstands high pressure cleaning)

Contains:

- 1 LED Light, mounting instructions and installation components



8000 lm

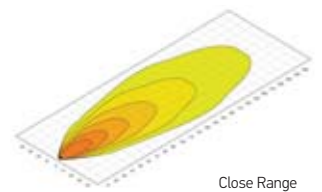
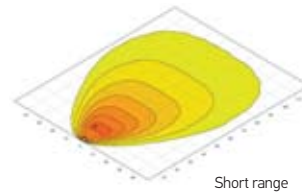
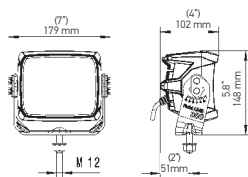

996197001	ZEROGLARE 24 V
996197011	Close Range 24 V
996197021	Longe range 24 V
996197041	Pencil beam 24 V

RokLUME 280

LED

- Powerful LED worklight designed for the roughest mining conditions
 - Heavy Duty bracket for extra strong resistance to vibration
 - Aluminum housing is protected with a special NanoSafe (non-sticky and easy to clean surface) coating
 - ZEROGLARE option for non-glare illumination
 - DT counterpart included
 - 5 year warranty
- Voltage: 9-33 VDC
 - Light Output (measured): 4,400 lm
 - Power Consumption: 55 Watt
 - Color Temperature: 5,000 Kelvin
 - Housing Material: Aluminum
 - Lens Material: Hardcoated PC lens
 - Connection: DT connector
 - Mounting: Heavy Duty bracket
 - Approvals: IP6K8, IP6K9K (withstands high pressure cleaning)

Contains:

- 1 LED Light
- Mounting instructions and installation components



4400 lm

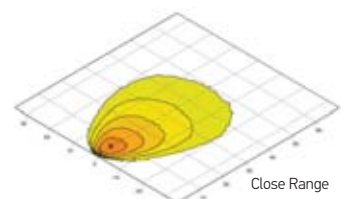
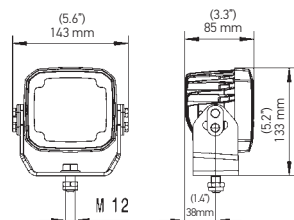

995606541	ZEROGLARE
995606501	Close Range
995606521	Pencil beam



Product image / Dimensions	Features	Technical Specifications	Part Number
----------------------------	----------	--------------------------	-------------

ULTRA BEAM LED GEN II



- LED**
- High performance LED worklight for various applications
 - The Ultra Beam LED Gen.2 provides twice as much light as Gen. 1
 - Available with standard U-bracket or the Heavy Duty surrounding bracket
 - Thermo Management to secure the perfect LED temperature at all times
 - 2 year warranty

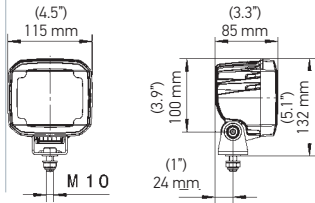

- Voltage: 9-33 VDC
- Light Output (measured): 4,000 lm
- Power Consumption: 55 Watt
- Color Temperature: 6,500 Kelvin
- Housing Material: Aluminum
- Lens Material: PC
- Connection: DT connector
- Mounting: Stainless steel U-bracket / Heavy Duty bracket
- Approvals: IP6K8, IP6K9K (withstands high pressure cleaning)

995606001	Close Range
995606011	Long Range
995606071	Close Range HD bracket
995606081	Long Range HD bracket

- Contains:**
- 1 LED Light
 - Mounting instructions and installation components

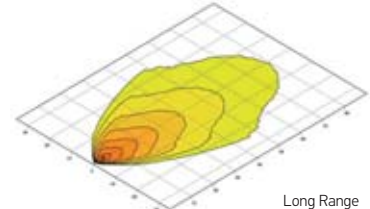
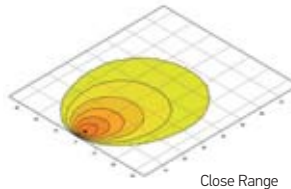

4000 lm

POWER BEAM 1500 LED



- LED**
- Compact and robust LED worklight
 - Heavy Duty bracket for strong vibration resistance and 180 degree mounting
 - Plastic cover on the back functions as handle for easy angle adjustments
 - Thermo Management to secure the perfect LED temperature at all times
 - 2 year warranty

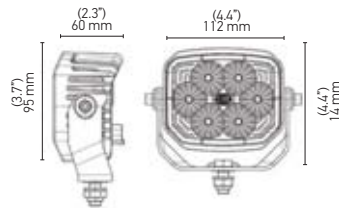

- Voltage: 9-33 VDC
- Light Output (measured): 1,350 lm
- Power Consumption: 22 Watt
- Color Temperature: 6,500 Kelvin
- Housing Material: Aluminum
- Lens Material: PC
- Connection: DT connector
- Mounting: Heavy Duty bracket
- Approvals: IP6K8, IP6K9K (withstands high pressure cleaning)

996288021	Long Range
996288031	Close Range

- Contains:**
- 1 LED Light
 - Mounting instructions and installation components

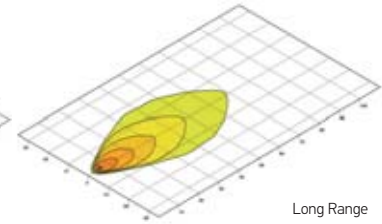
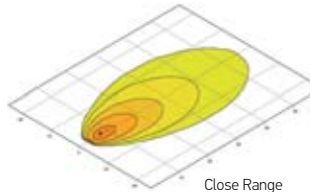

1350 lm

ROKLUME 190 TP



- LED**
- Thermo-conductive plastic housing for 100% corrosion resistance
 - Reinforced fiber-glass plastic U-bracket withstands even the hardest impacts
 - Thermo Management to secure the perfect LED temperature at all times
 - Ideal for service pick-up trucks on mine-sites, tow trucks and construction vehicles
 - 2 year warranty

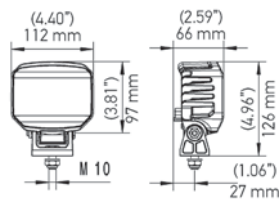

- Voltage: 10.5-32 VDC
- Light Output (measured): 1,850 lm
- Power Consumption: 26 Watt
- Color Temperature: 5,000 Kelvin
- Housing Material: Thermo Plastic
- Lens Material: PC
- Connection: DT connector
- Mounting: Reinforced fibre-glass bracket
- Approvals: IP6K8, IP6K9K (withstands high pressure cleaning)

996488501	Close Range
996488511	Long Range

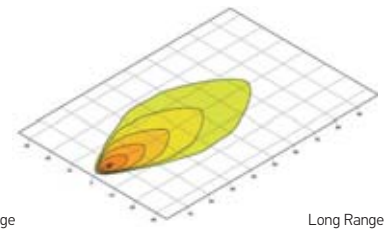
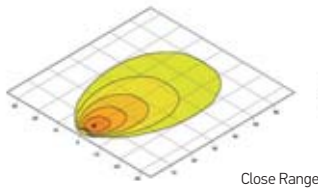

1850 lm

ROKLUME 155 TP



- LED**
- Compact thermo-conductive plastic housing for 100% corrosion resistance
 - Reinforced fiber-glass plastic U-bracket withstands even the hardest impacts
 - Thermo Management to secure the perfect LED temperature at all times
 - Ideal for service pick-up trucks on mine-sites, tow trucks and construction vehicles
 - 2 year warranty

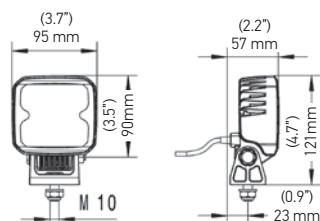

- Voltage: 9-33 V
- Light Output (measured): 1,200 lm
- Power Consumption: 15 Watt
- Color Temperature: 5,000 Kelvin
- Housing Material: Thermo Plastic
- Lens Material: PC
- Connection: 12 " cable with DT connector
- Mounting: Reinforced fibre-glass bracket
- Approvals: IP6K8, IP6K9K (withstands high pressure cleaning)

996284051	Close Range
996284061	Long Range

- Contains:**
- 1 LED Light
 - Mounting instructions

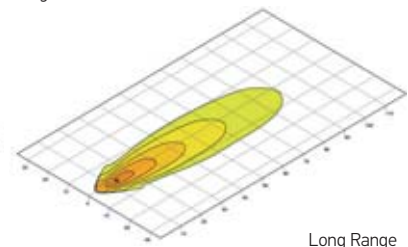
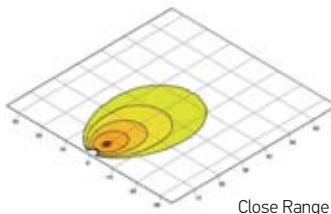

1200 lm

Product image / Dimensions	Features	Technical Specifications	Part Number
----------------------------	----------	--------------------------	-------------

MODULE 70 LED GEN 4

2500 lm
LED

- Most powerful HELLA LED worklight in this round size
- 3 Powerful multichip LEDs generate a widespread homogenous light distribution
- Thermo Management to secure the perfect LED temperature at all times
- LED searchlight comes with handle, switch and spiral cable with lighter plug
- 2 year warranty

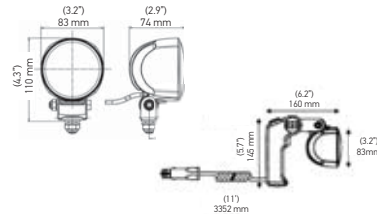

- Voltage: 9 -33 VDC
- Light Output (measured): 2,500 lm
- Power Consumption: 30 Watt
- Color Temperature: 6,500 Kelvin
- Housing Material: Aluminum
- Lens material: Glass
- Connection: 6.5ft cable with open wires / Searchlight: 11ft spiral cable with lighter plug
- Mounting: Stainless steel / handle with switch
- Approvals: IP6K8, IP6K9K (withstands high pressure cleaning)

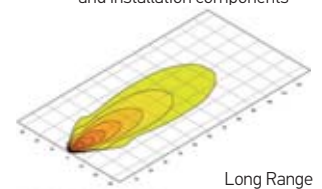
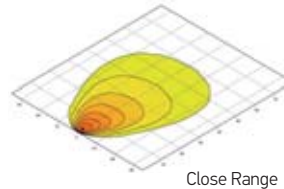

- 996476001** Close Range
- 996476011** Long Range
- 996476501*** Spot Light Searchlight
- 996476511*** Close Range Searchlight

*Special order item

- Contains:**
- 1 LED Light, mounting instructions and installation components

MODUL 70 LED GEN 3.2

1800 lm
LED

- The new Generation 3.2 provides 2x the light than the old Module 70 LED Gen. 3
- Compact size perfect for various applications
- Homogenous light distribution generates perfect working conditions around your vehicle
- Thermo Management to secure the perfect LED temperature at all times
- 2 year warranty

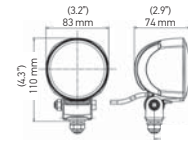

- Voltage: 9-33 VDC
- Light Output (measured): 1,800 lm
- Power Consumption: 20 Watt
- Color Temperature: 6,500 Kelvin
- Housing Material: Aluminum
- Lens Material: Glass
- Connection: 6.5ft cable with open wire leads
- Mounting: Stainless steel bracket
- Approvals: IP6K8, IP6K9K (withstands high pressure cleaning)

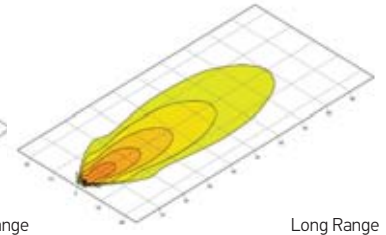
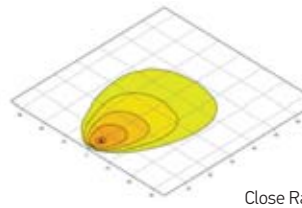

- 996576031** Close Range
- 996576001** Long Range

- Contains:**
- 1 LED Light
 - Mounting instructions and installation components

OVAL 90 LED GEN 2

5000 lm
LED

- High performance LED worklight for various applications
- The Oval 90 LED Gen.2 provides 2x as much light as Gen. 1
- Curved lens provides an extra wide spread illumination to the outer areas
- Thermo Management to secure the perfect LED temperature at all times
- 2 year warranty

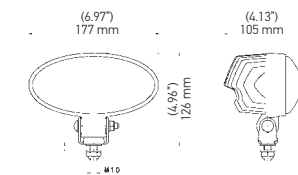

- Voltage: 9-33 VDC
- Light Output (measured): 5,000 lm
- Power Consumption: 60 Watt
- Color Temperature: 6,500 Kelvin
- Housing Material: Aluminum
- Lens Material: PC
- Connection: DT connector
- Mounting: Stainless steel bracket
- Approvals: IP6K8, IP6K9K (withstands high pressure cleaning)

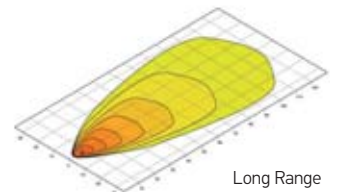
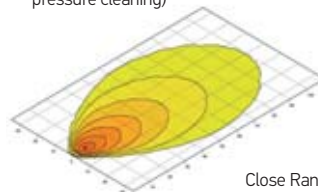

- 996486001** Close Range
- 996486011** Long Range

- Contains:**
- 1 LED Light
 - Mounting instructions and installation components

OVAL 100 LED GEN 2

4400 lm
LED

- High performance LED worklight for various applications
- The Oval 100 LED Gen.2 provides 2x as much light as Gen. 1
- Oval design gives the light a very modern look
- Thermo Management to secure the perfect LED temperature at all times
- 2 year warranty

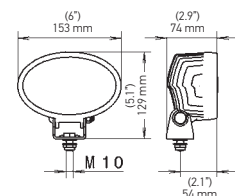

- Voltage: 9-33 VDC
- Light Output (measured): 4,400 lm
- Power Consumption: 56 Watt
- Color Temperature: 6,500 Kelvin
- Housing Material: Aluminum
- Lens Material: PC
- Connection: DT connector
- Mounting: Stainless steel bracket
- Approvals: IP6K8, IP6K9K (withstands high pressure cleaning)

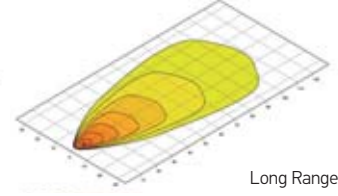
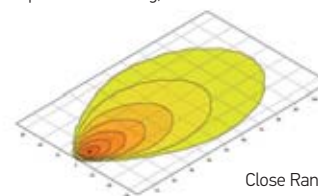

- 996761001** Close Range
- 996761011** Long Range

- Contains:**
- 1 LED Light
 - Mounting instructions and installation components



Product image / Dimensions	Features	Technical Specifications	Part Number
----------------------------	----------	--------------------------	-------------

OVAL 100 H3

HALOGEN

- Classic oval halogen worklight
- HELLA Free-Form reflector optimizes light distribution
- H3 bulb included
- 2 year warranty

- Voltage: 12 VDC
- Light Output (measured): 1,150 lm / 2,300 lm
- Power Consumption: 55 / 110 Watt
- Color Temperature: 2,500 Kelvin
- Housing Material: HD Plastic
- Lens Material: Glass
- Connection: 6 " cable with open wire leads
- Mounting: Stainless Steel bracket
- Protection: IP5K9K (pressure cleaner proof)

358115061 Long Range
(H15161031) 2 X H3

- Contains:**
- 1 Halogen Light
 - Mounting instructions and installation components

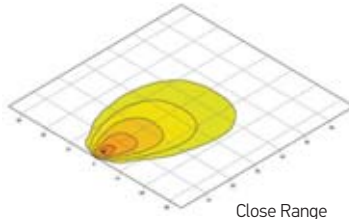
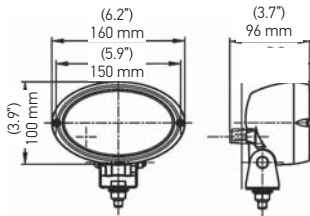

Close Range

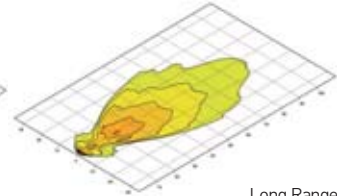

Long Range

1150 lm

ULTRA BEAM H3

HALOGEN

- The classic halogen worklight
- HELLA Free-Form reflector technology optimizes light distribution
- H3 bulb included
- 2 year warranty

- Voltage: 12 VDC
- Light Output (measured): 1,150 lm
- Power Consumption: 55 Watt
- Color Temperature: 2,500 Kelvin
- Housing Material: HD Plastic
- Lens Material: Glass
- Connection: AMP connector with 4 " cable with open wires
- Mounting: Stainless Steel bracket
- Protection: IP5K9K (pressure cleaner proof)

358115111 Close Range
(H15506021)

- Contains:**
- 1 Halogen Light
 - Mounting instructions and installation components

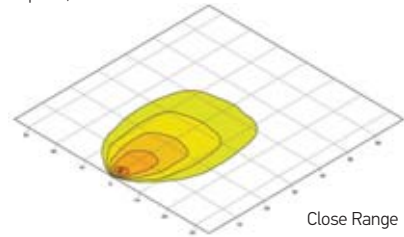
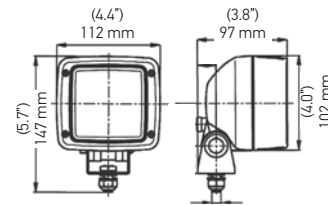

Close Range

1150 lm

MODULE 70 H3

HALOGEN

- Compact halogen worklight for applications with tight mounting options
- Easily accessible H3 bulb (included) - no tools required for bulb replacement
- Cable feed through an opening in the rubber cap
- 2 year warranty

- Voltage: 12 VDC
- Light Output (measured): 1,150 lm
- Power Consumption: 55 Watt
- Color Temperature: 2,500 Kelvin
- Housing Material: HD Plastic
- Lens Material: Glass
- Connection: Cable with open wire leads
- Mounting: Stainless Steel bracket
- Protection: IP5K9K (pressure cleaner proof)

996176491 Close Range
Flush mount

- Contains:**
- 1 Halogen Light
 - Mounting instructions and installation components

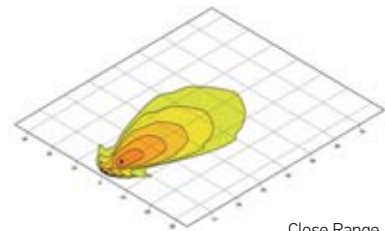
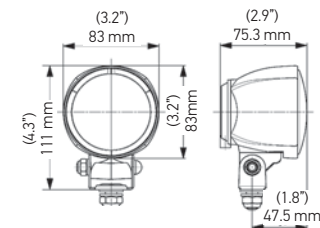

Close Range

1150 lm

MATADOR H3

HALOGEN

- Halogen worklight with protective grill to protect glass lens from rock chips
- 4-point Omega bracket for versatile surface mounting options
- Comes with an integrated switch
- H3 bulb included
- 2 year warranty

- Voltage: 12 VDC / 24 VDC
- Light Output (measured): 1,150 lm / 1,300 lm
- Power Consumption: 55 Watt / 70 Watt
- Color Temperature: 2,500 Kelvin
- Housing Material: HD Plastic
- Lens Material: Glass
- Connection: Cable with open wire leads
- Mounting: Stainless Steel bracket
- Protection: IP5K9K (pressure cleaner proof)

358115281 12V
Close Range
(H15470001)

003470911 24V
Close Range
(H15470011)

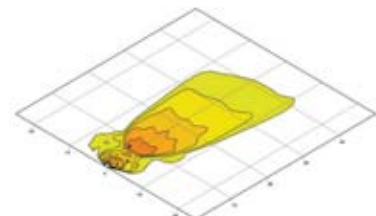
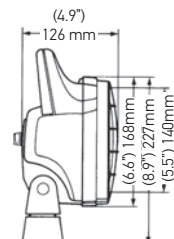

1150 lm

Product image / Dimensions	Features	Technical Specifications	Part Number
----------------------------	----------	--------------------------	-------------

C140 LED HEADLAMPS
LED

- Upgrade your vehicle with HELLAs latest LED snowplow lights
- All four light functions in LED: high beam, low beam, direction indicator and PO light
- Integrated 6-pin DT connector for a sealed and safe connection
- 2 year warranty

- Voltage: 10 - 32 VDC
- Power Consumption: 25 / 40 Watt
- Light Output: Low Beam, High Beam, Indicator, Position
- Color Temperature: 6,000 Kelvin
- Housing Material: Aluminum
- Lens Material: PC
- Connection: 6 pin DT connector
- Mounting: HD stainless steel bracket
- Approvals: ECE, SAE, IP6K9K (withstands high pressure cleaning)

996374011 Left

996374021 Right

- Contains:**
- 1 LED Light
 - Mounting instructions and installation components

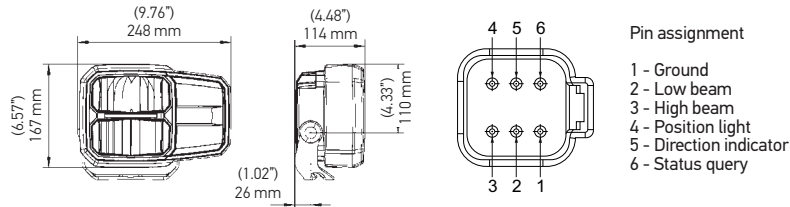
C220 COMBINATION HEADLAMPS
HALOGEN

- Stylish combination headlights / snowplow light
- HELLA Free-Form reflector technology provides superior illumination
- Heavy Duty vibration dampened mounting stud bracket
- 12V bulbs are included
- 2 year warranty

- Voltage: 12 VDC
- Light Output: Low Beam, High Beam, Indicator, Position
- Color Temperature: 2,500 Kelvin
- Housing Material: HD Plastic
- Lens Material: Glass
- Connection: 6 pin DT connector
- Mounting: Heavy Duty stud bracket
- Approvals: ECE, IP5K9K (pressure cleaner proof)
- Light Source: 12 V H7/H3/P21W/T4W

996174251 Left

996174261 Right

- Contains:**
- 1 Halogen Light
 - Mounting instructions and installation components

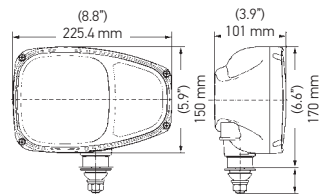
2500 lm
C120 COMBINATION HEADLAMPS
HALOGEN

- Oval shaped combination headlights / snowplow light
- HELLA Free-Form reflector technology provides superior illumination
- Heavy Duty vibration dampened stud mounting bracket
- 12V bulbs are included
- 2 year warranty

- Voltage: 12 VDC
- Light Output: Low Beam, High Beam, Indicator, Position
- Color Temperature: 2,500 Kelvin
- Housing Material: HD Plastic
- Lens Material: Glass
- Connection: 6 pin DT connector
- Mounting: Surface or bracket mount
- Approvals: ECE, SAE, IP5K9K (pressure cleaner proof)
- Light Source: 12 V H7/H3/P21W/T4W

996167051 Left

996167061 Right

996167191 Left, Stud

996167201 Right, Stud

- Contains:**
- 1 Halogen Light
 - Mounting instructions and installation components

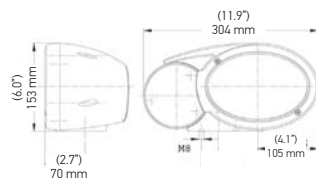
2500 lm
M120 COMBINATION HEADLAMPS
HALOGEN

- Classic square shaped combination headlights / snowplow light
- HELLA Free-Form reflector technology provides superior illumination
- Heavy Duty vibration dampened stud mounting bracket
- 12 V bulbs are included
- 2 year warranty

- Voltage: 12 VDC
- Light Output: Low Beam, High Beam, Indicator, Position
- Color Temperature: 2,500 Kelvin
- Housing Material: HD Plastic
- Lens Material: Glass
- Connection: 6 pin DT connector
- Mounting: Heavy Duty stud bracket
- Approvals: ECE, IP5K9K (pressure cleaner proof)
- Light Source: 12 V H7/H3/P21W/T4W

996120051 12V, Left

996120061 12V, Right

- Contains:**
- 1 Halogen Light
 - Mounting instructions and installation components

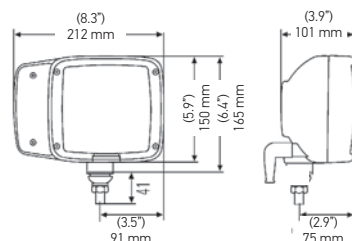
2500 lm
996081277

DISCOVER: LIGHT BARS HELLA OWS
FULL SIZE! Available in 48", 56" and 60",
as well as the HELLA MINI LIGHT BAR 10"
and 16"





OPTICAL WARNING SYSTEMS

The Optical Warning Systems (OWS), the KL series signaling systems, the rotating lamps, beacons and their constant technological implementations make HELLA products so special. Rotating lamps, flashers, warning lights: this is where our specialists combine the best technology with extreme resistance. The result: high-quality LED technology, modern reflector technology, which resists even the toughest weather and working conditions as well as a continuous service without compromising its operation.

HELLA allows you to be absolutely safe and visible at all times.



MICROSITE: Find more information at:



www.hellahd.com



HELLA FULL SIZE LED LIGHTBAR



- Choose from 8 different lightbar options varying in sizes to fit your car, truck or light commercial vehicle
- Available in lengths of 48", 56" and 60"
- Stop/Tail/Turn Alley Lights and Take-Down Light options
- Smoked lens design for a stealth look
- All lightbars come with integrated traffic director functionality
- Easy maintenance with top accessibility
- Can be mounted permanently or temporarily using strap kits
- 5 year warranty

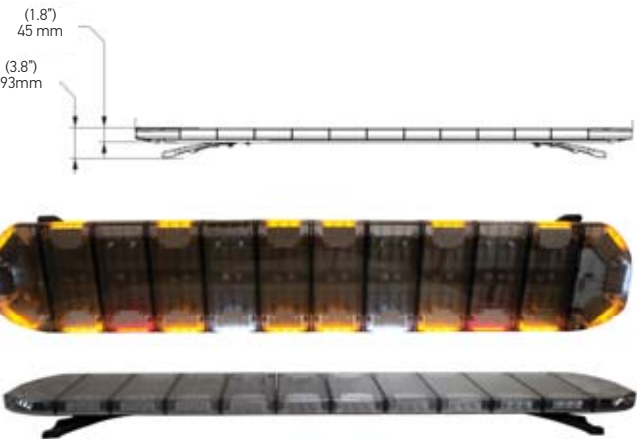

Technical Data	
Voltage:	10-30 VDC
Flash Pattern:	29 user selectable flash pattern
Approvals:	SAE J845 Class 1 , California Title 13
Colors:	Amber, Red, Blue, Green
Power Consumption:	103 / 130 / 143 / 182 Watt
Mounting:	Bracket or vehicle specific strap kits (separate purchase)
Connection:	10ft cable with open wire leads
IP Rating	IP 67

Description	Color	Part Number
LB4800A	● LED Light Bar, 48", Amber	358111781 (H27941001)
LB4800AL	● LED Light Bar, 48", Amber, with takedown and alley lights	358111871 (H27941091)
LB4800AGL	● LED Light Bar, 48", Amber / Green, with takedown and alley lights	358111821* (H27941041)
LB4800RBL	● LED Light Bar, 48", Red / Blue, with takedown and alley lights	358111841* (H27941061)
LB4800RL	● LED Light Bar, 48", Red, with takedown and alley lights	358111851* (H27941071)
LB4800BL	● LED Light Bar, 48", Blue, with takedown and alley lights	358111861* (H27941081)
LB5600AL	● LED Light Bar, 56", Amber, with stop, tail, turn, takedown and alley lights	358111801 (H27941021)
LB6000AL	● LED Light Bar, 60", Amber, with stop, tail, turn, takedown and alley lights	358111811 (H27941031)

* Special order item

358111781

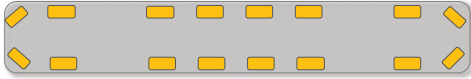

358111871



358111821



358111841

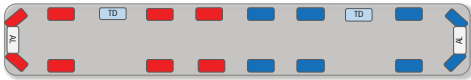

358111851

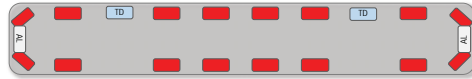

358111861

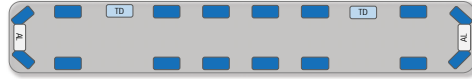

358111801

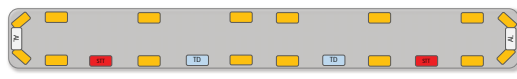

358111811

Description

- LED amber module
- LED green module
- LED red module
- LED blue module
- Flasher
- Takedown light
- Alley Lights

HELLA LED LIGHT BAR STRAP KITS

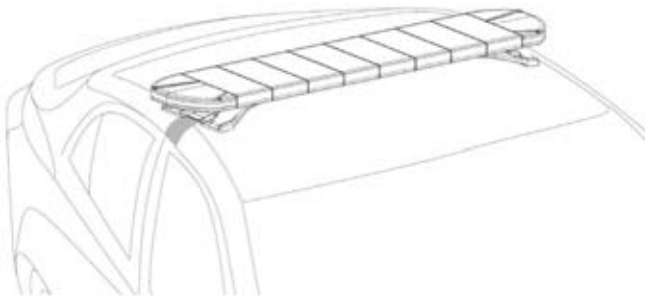

Applications	Years	Part Number
CHEVY IMPALA	2014 - 2015	358115551 (H27942011)
CHEVY SILVERADO	2014 - 2018	358115561 (H27942021)
CHEVY TAHOE	2007 - 2014	358115571 (H27942031)
GMC YUKON	2001 - 2014	358115581 (H27942041)
DODGE CHARGER	2011 - 2020	358115591 (H27942051)
DODGE RAM 1500	2012 - 2019	358115601 (H27942061)
DODGE RAM 1500-3500	2010 - 2011	358115611 (H27942081)
FORD EXPLORER	2013 - 2019	358115631 (H27942101)
FORD F150 - F550	2015 - 2020	358115641 (H27942111)
FORD F150	2004 - 2014	358115651 (H27942121)
FORD F250 - 550	1999 - 2016	358115661 (H27942131)
FORD TAURUS	2013 - 2019	358115671 (H27942141)

HELLA LED LIGHT BAR CONTROLLER



- 360 adjustable bracket mounting
- Seven auxiliary functions can be switched
- Independent control of power
- Mounted to any angled surface
- Supports controlling of light bar and traffic advisor
- Audio and visible feedback

Description

HELLA LED Light Bar Controller

358115681
(H27943001)



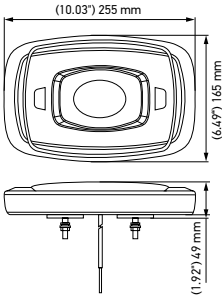

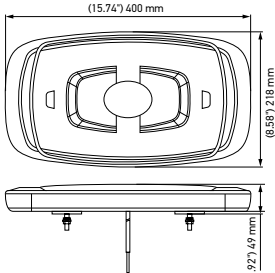

Product image / Dimensions	Features	Technical Specifications	Part Number
10" MINI LIGHTBAR 	<ul style="list-style-type: none"> • 10" mini lightbar • Amber light output in both clear and amber lenses • Multiple user selectable flashing options including rotating pattern • Bracket or magnetic mounting options • 5 year warranty 	<ul style="list-style-type: none"> • Voltage: 10-30 VDC • Flash Pattern: 10 user selectable flash pattern • Approval: SAE J845 Class 1, ECE-R10, EMC CISPR 25 Class 3, IP6K9K (withstands high pressure cleaning) • Colors: Amber, Amber/White • Power Consumption: 70 Watt • Mounting: Fixed or Magnet mount • Connection: Fixed mount: 20" cable with open wire leads, Magnet: 10ft spiral cable with lighter plug + switches 	014566111 Fixed, Clear Lens, Amber
			014566311* Fixed, Amber Lens, Amber
			014566411 Fixed, Clear Lens, Amber/White
			014566121 Magnet, Clear Lens, Amber
			014566321* Magnet, Amber Lens, Amber
			014566421 Magnet, Clear Lens, Amber/White

* Special order item

16" MINI LIGHTBAR 	<ul style="list-style-type: none"> • 16" mini lightbar • Amber light output in both clear and amber lenses • Multiple user selectable flashing options including rotating pattern • Bracket or magnetic mounting options • 5 year warranty 	<ul style="list-style-type: none"> • Voltage: 10-30 VDC • Flash Pattern: 10 user selectable flash pattern • Approval: SAE J845 Class 1, ECE-R10, EMC CISPR 25 Class 3, IP6K9K (withstands high pressure cleaning) • Colors: Amber, Amber/White • Power Consumption: 70 Watt • Mounting: Fixed or Magnet mount • Connection: Fixed mount: 20" cable with open wire leads, Magnet: 10ft spiral cable with lighter plug + switches 	014565111 Fixed, Clear Lens, Amber
			014565311* Fixed, Amber Lens, Amber
			014565411 Fixed, Clear Lens, Amber/White
			014565121 Magnet, Clear Lens, Amber
			014565321* Magnet, Amber Lens, Amber
			014565421 Magnet, Clear Lens, Amber/White

* Special order item

MLB 50 LED 	<ul style="list-style-type: none"> • 14" classic design mini lightbar • Low power function for night time use • Available in permanent and vacuum magnet mount • 5 year warranty 	<ul style="list-style-type: none"> • Voltage: 10-30 VDC • Flash Pattern: 24 user selectable flash pattern • Approval: SAE J845 Class 1, California Title 13, ECE-R10 • Colors: Amber, Amber/White • Power Consumption: 70 Watt • Mounting: Fixed, Magnet mount • Connection: Fixed mount: 10" cable with open wire leads, Magnet: 10ft spiral cable with lighter plug + switches 	358111431 (H27995001) Fixed Amber
			358111441 (H27995011) Magnet, Amber
			358111451 (H27995021) Fixed Amber/White
			358111461 (H27995031) Magnet Amber/White

MLB 100 LED LIGHT BAR 	<ul style="list-style-type: none"> • Non-volatile memory recalls last flash pattern • Multiple units can be synchronized • Reverse polarity protection • Weatherproof and vibration resistant design for external use • 5 year warranty 	<ul style="list-style-type: none"> • Light Source: 30 LEDs • Warning Patterns: 23 Flash Patterns • Operating Voltage: 12 /24 VDC • Max Power: 50 W • Approvals: SAE J845 Class 1, California Title 13, ECE R65, ECE R10 • Connection Fixed: 12" (30 cm) wire leads • Connection Magnet: 10' (3 m) lighter plug with on/off and pattern select switch • Multi-Unit Sync: Over 15 units • Operating Temperature: -30°C to +60°C • IP Rating: IP67 	358111471 (H27996001) Fixed Amber
			358111481 (H27996011) Magnet Amber
			358111511 (H27996041) Fixed Amber/White
			358111521 (H27996051) Magnet Amber/White
			358111531* (H27996061) Fixed Red/Blue
			358111541* (H27996071) Magnet Red/Blue
			358111551* (H27996081) Fixed Blue

* Special order item

Product image / Dimensions	Features	Technical Specifications	Part Number
----------------------------	----------	--------------------------	-------------

MLB 200 LED LIGHT BAR

LED

- 16" low profile warning lightbar (just 1.4" height)
- Available in various colors and different mounting options
- Weatherproof and vibration resistant
- 5 year warranty

- Voltage: 10-30 VDC
- Flash Pattern: 24 user selectable flash pattern
- Approval: SAE J845 Class 1, California Title 13, ECE-R10
- Colors: Amber, Amber/White
- Power Consumption: 74 Watt
- Mounting: Fixed, Magnet mount
- Connection: Fixed mount: 10" cable with open wire leads, Magnet: 10ft spiral cable with lighter plug + switches

358111561 (H27997001)	Fixed Amber
358111571 (H27997011)	Magnet Amber
358111581 (H27997021)	Fixed Amber/White
358111591 (H27997031)	Magnet Amber/White

MLB 200 LED COLOR DUAL LIGHT BAR

LED

- 16" low profile warning lightbar (just 1.4" height)
- Dual memory allows for easy switching between two different color modes
- Available in various colors and different mounting options
- 5 year warranty

- Voltage: 10-30 VDC
- Flash Pattern: 24 user selectable flash pattern
- Approval: SAE J845 Class 1, California Title 13, ECE-R10
- Colors: Amber/White, Amber/Blue
- Power Consumption: 72 Watt
- Mounting: Fixed, Magnet mount
- Connection: Fixed mount: 10" cable with open wire leads, Magnet: 10ft spiral cable with lighter plug + switches

358111601 (H27997501)	Fixed Amber/White
358111611 (H27997511)	Magnet Amber/White
358111621 (H27997521)	Fixed Amber/Blue
358111631 (H27997531)	Magnet Amber/Blue



K-LED 100 LED

LED

- Modern round beacon (SAE J845 Class 1)
- High and compact low dome option
- Various mounting options including the DIN pole mount
- 5 year warranty

- Voltage: 10-30 VDC
- Flash Pattern: 11 / 14 user selectable flash pattern
- Approval: SAE J845 Class 1, California Title 13, ECE R65, ECE R10
- Color: Amber
- Power Consumption: 42 / 30 Watt
- Mounting: Fixed, Magnet, Pole mount
- Connection: Fixed mount: 10" cable with open wire leads, Magnet: 10ft spiral cable with lighter plug + switches

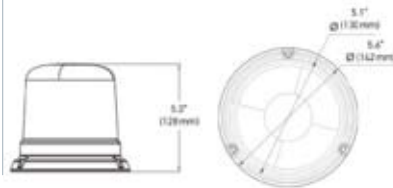
358113811 (H27112001)	Fixed Mount
358114791 (H27112011)	Magnet
358114801 (H27112031)	DIN Pole



K-LED 100 COMPACT LED

LED





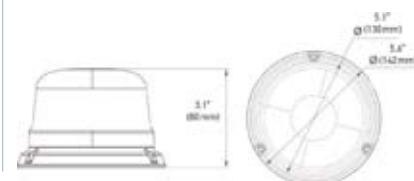

- Modern round beacon (SAE J845 Class 1)
- High and compact low dome option
- Various mounting options including the DIN pole mount
- 5 year warranty

- Voltage: 10-30 VDC
- Flash Pattern: 11 / 14 user selectable flash pattern
- Approval: SAE J845 Class 1, California Title 13, ECE R65, ECE R10
- Color: Amber
- Power Consumption: 42 / 30 Watt
- Mounting: Fixed, Magnet, Pole mount
- Connection: Fixed mount: 10" cable with open wire leads, Magnet: 10ft spiral cable with lighter plug + switches

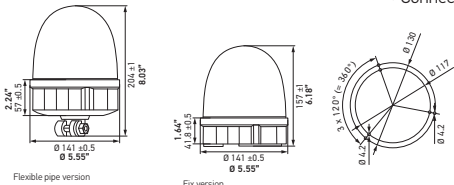
358114821 (H27114001)	Fixed Mount
358114831 (H27114011)	Magnet

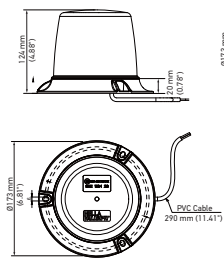

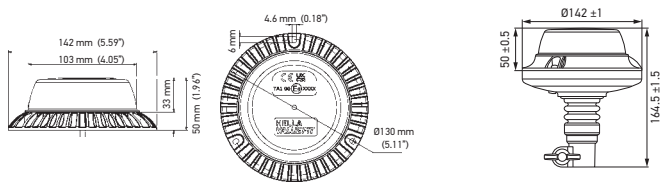

Product image / Dimensions	Features	Technical Specifications	Part Number
<p>ROTA FLASH COMPACT LED</p> 	<p>LED</p> <ul style="list-style-type: none"> Choice of preferred function: rotating or flashing CISPR 25 Class 3 Interference protection and ADR certification, ensure safe operation on vehicles transporting dangerous goods Perfect solution for upgrade or retrofit vehicles with a design that matches the legacy halogen beacon Round beacon, modern design 5 year warranty  <p>Flexible pipe version Fix version</p>	<ul style="list-style-type: none"> Voltage: 9-32 VDC Flash pattern: Rotating and Flashing Approval: SAE J845 Class 1, ECE R65, CISPR 25 Class 3 Color: Amber Power consumption: 11 Watt Current consumption: Rotating: 0.60 A @ 9 V Flashing: 2.22 A @ 9 V Housing and dome material: PC + ABS Mounting: Fixed and pipe Connection: 5.9" cable (150 mm) with open leads 	<p>013878001 Amber, Fixed</p> <hr/> <p>013878011 Amber, Pipe</p>
<p>HELLA VALUEFIT WHITE BEACON DOUBLE FLASH</p> 	<p>LED</p> <ul style="list-style-type: none"> LED beacon in classic tall trapezoidal design with clear lens Generates a high warning effect with all-round visibility due to its tall design With double flashing white signal function Classic clear dome 5 year warranty 	<ul style="list-style-type: none"> Voltage: 10-30 VDC Flash pattern: Two pulses in one flash (0.8 - 2Hz) Approval: SAE J845 Class 1, ECE R10, ROHS Color: White Power consumption: 24 Watt Synchronization: Up to 8 units Housing and dome material: Clear, impact resistant polycarbonate / ABS Mounting: Fixed Connection: 11.41" (290mm) cable with open wires 	<p>357981001 White, Double Flash</p>
<p>HELLA VALUEFIT SLIM</p> 	<p>LED</p> <ul style="list-style-type: none"> Round beacon, modern design Die-cast aluminum housing contributes to high thermal efficiency. Available in Amber Number of LEDs: 24 Type of protection: IP67, IP 6K9K Protection against polarity reversal and overvoltage 5 year warranty 	<ul style="list-style-type: none"> Voltage: 10-30 VDC Flash pattern: 2 patterns: Single and double Approval: SAE J845 Class 1, ECE R65, ECE R10, Color: Amber Power consumption: 10 Watt Housing and dome material: PC Mounting: Fixed Connection: 3 m cable with open leads 	<p>357980001 Amber, Fixed Single/double flash</p> <hr/> <p>357980011 Amber, Pipe Double flash</p>
<p>HELLA SOS 360° WARNING LIGHT</p> 	<p>LED</p> <ul style="list-style-type: none"> The perfect accompaniment to the warning triangle in the vehicle. The first priority in the event of any breakdown is securing of the scene of the accident. But until the warning triangle is set up, the vehicle remains unsecured – a danger for all road users that should not be underestimated, especially in the dark. This is exactly where the innovative HELLA SOS 360° warning light comes into play: once placed on the roof in flash by means of its magnetic mount, it generates an easily perceptible amber, all-round warning signal thanks to its high-performance LEDs. Visible up to 1 km (0.62 miles) away. The SOS 360° lamp can also be used as a powerful LED torch or as a white LED work light. <p>Warning function for greater safety Once placed on the roof, the SOS 360° warning lamp generates an amber all-round warning light. Completely without moving parts and visible up to 1 km away. Simply safe!</p>	<ul style="list-style-type: none"> Voltage: 9 V battery operation Light function: Two magnetically activated light functions (amber warning light and white working light), Approval: CE tested Mounting: Magnet <p>Compact design, quick mounting The SOS 360° warning lamp is easily stowed away and is always ready to hand. Can be mounted on the vehicle roof in a flash thanks to its magnetic activation feature.</p>	<p>359001001 SOS 360°</p> <p>Product Video:</p>  <p>Torch function for more visibility Manual switching enables the warning lamp to be changed to a bright white continuous light, when work has to be carried out, for example, in the engine compartment. Simply practical!</p>



Product image / Dimensions	Features	Technical Specifications	Part Number
----------------------------	----------	--------------------------	-------------

K-LED 50

LED

- Modern round beacon (SAE J845 Class 1)
- High and compact low dome option
- Available in amber and white
- 5 year warranty

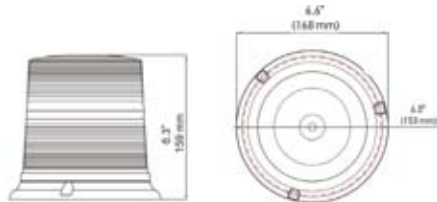

- Voltage: 10-30 VDC
- Flash Pattern: 15 user selectable flash pattern
- Approval: SAE J845 Class 1, ECE R10
- Colors: Amber, White
- Power Consumption: 22 Watt
- Mounting: Fixed, Magnet mount
- Connection: Fixed mount: 16 " cable with open wire leads, Magnet: 10ft spiral cable with lighter plug + switches

358114761 (H27111001) Fixed Mount

358114771 (H27111011) Magnet

K-LED 50 COMPACT

LED

- Modern round beacon (SAE J845 Class 1)
- High and compact low dome option
- Available in amber and white
- 5 year warranty

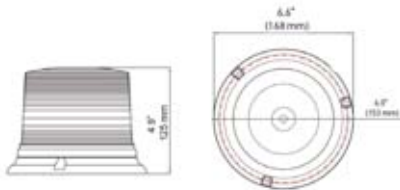

- Voltage: 10-30 VDC
- Flash Pattern: 15 user selectable flash pattern
- Approval: SAE J845 Class 1, ECE R10
- Colors: Amber, White
- Power Consumption: 22 Watt
- Mounting: Fixed, Magnet mount
- Connection: Fixed mount: 16 " cable with open wire leads, Magnet: 10ft spiral cable with lighter plug + switches

358114811 (H27113001) Fixed Mount

358113821 (H27113011) Magnet

K-LED 40

LED

- Perfect entry level LED beacon (SAE J845 Class 2)
- High and compact low dome option
- Available as permanent fixed mount or temporarily magnet mount
- 5 year warranty

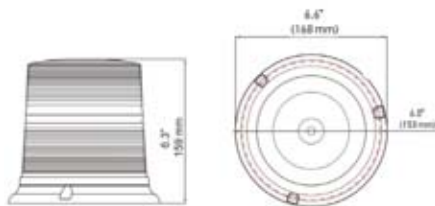

- Flash Pattern: 5 user selectable flash pattern
- Approval: SAE J845 Class 2
- Color: Amber
- Power Consumption: 3 Watt
- Mounting: Fixed, Magnet mount
- Connection: Fixed mount: 16 " cable with open wire leads, Magnet: 10ft spiral cable with lighter plug + switches

358114701 (H27117001) Fixed Mount

358114711 (H27117011) Magnet

K-LED 40 COMPACT

LED

- Perfect entry level LED beacon (SAE J845 Class 2)
- High and compact low dome option
- Available as permanent fixed mount or temporarily magnet mount
- 5 year warranty

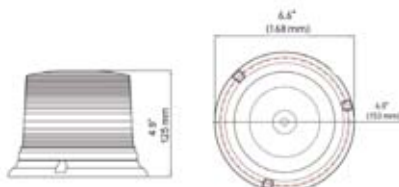

- Flash Pattern: 5 user selectable flash pattern
- Approval: SAE J845 Class 2
- Color: Amber
- Power Consumption: 3 Watt
- Mounting: Fixed, Magnet mount
- Connection: Fixed mount: 16 " cable with open wire leads, Magnet: 10ft spiral cable with lighter plug + switches

358114681 (H27115001) Fixed Mount

358114691 (H27115011) Magnet

Product image / Dimensions	Features	Technical Specifications	Part Number
----------------------------	----------	--------------------------	-------------

K-LED REBELUTION



LED

- Innovation and change – that's what the KLED Rebelution beacon stands for. The narrow light exit area is setting new standards in the beacon market. The most striking feature of the KLED Rebelution is its unique and unconventional design. It manages without a classical dome and impresses with its discreet, futuristic styling.
- The low profile design gives it a stealth look for a perfect vehicle design integration.
- 2 year warranty

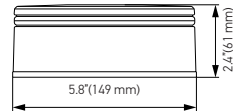

- Voltage: 10-30 VDC
- Flash Pattern: flashing (1 pattern) or rotating (1 pattern/speed)
- Approval: ECE-R65, SAE Class 2 (outstanding)
- Color: Amber
- Power Consumption: 38 / 13 Watt
- Mounting: Fixed mount
- Connection: 6 " cable with open wire leads,

455255001 Fixed, flashing

455256001 Fixed, rotating

K-LED NANO



LED

- The HELLA K-LED Nano is the smallest beacon in the HELLA range to date. Despite its compact dimensions, it achieves an attention-grabbing warning effect with its flashing, long-range amber light signal. Thanks to the energy-efficient, long-life LED technology, the warning signal is generated without moving parts
- Vibration and impact-resistant
- High degree of tightness thanks to complete sealing
- 2 year warranty

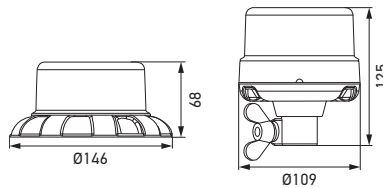

- Voltage: 12VDC / 24 VDC
- Flash Pattern: flashing warning signal
- Approval: SAE, CISPR 25 Class, ADR/GGVS, ECE-R65, ECE-R10, RCM
- Color: Amber
- Protection: IP6K7, IP6K9
- Power Consumption: 5 Watt
- Mounting: Fixed mount and Pipe mount
- Connection: 150 mm cable with 6.3 x 0.8 – 1.5 flat connector

066146001 Fixed Mount

066146011 Pipe Mount

ROTALED



LED

- The classic HELLA LED beacon (SAE J845 Class 1, CT13, ECE,...)
- Fulfills all legal requirements
- Low energy consumption makes this beacon ideal for continued use
- 2 year warranty

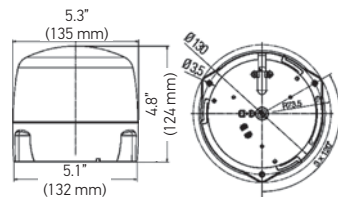

- Voltage: 10-30 VDC
- Flash Pattern: 5 user selectable flash pattern
- Approval: SAE J845 Class 1, ECE R65, ECE R10, CISPR25 Class 5
- Color: Amber
- Power Consumption: 10 Watt
- Mounting: Fixed, Flex mount
- Connection: Fixed mount: cable with open wire leads, Flex: DIN plug

010979001 Fixed Mount

010979011 Flex Mount

FL MINI



LED

- Super compact LED beacon (SAE J845 Class 3)
- Wide voltage range up to 80 VDC
- Designed for Forklifts with UL approval
- 2 year warranty

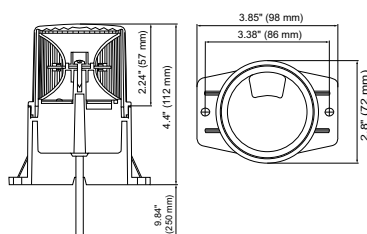

- Voltage: 10-80 VDC
- Flash Pattern: 1 flashing pattern
- Approval: ECE, SAE J845 Class 3, UL
- Color: Amber
- Power Consumption: 8 Watt
- Mounting: Fixed mount
- Connection: Fixed mount: 10 " cable with open wire leads

014959111 Fixed Mount



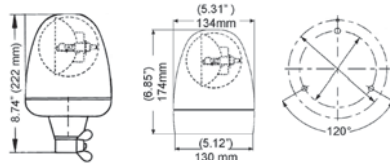

Product image / Dimensions	Features	Technical Specifications	Part Number
KL ROTAFLEX / KL ROTAFIX 	HALOGEN <ul style="list-style-type: none"> Sturdy dome with smooth easy-to-clean surface Various mounting options Fixed installation possible from the top or bottom DIN Pole flexible pipe socket with shock absorption 2 year warranty 	<ul style="list-style-type: none"> Voltage: 12 or 24 VDC Flash Pattern: Rotating 160 RPM Approval: SAE J845 Class 1, ECE R65, ECE R10 Color: Amber Power Consumption: 75 / 95 Watt Mounting: Fixed, Magnet, Flex mount Connection: Fixed mount: 7.5" cable with open wires, Magnet: 10' spiral cable with cigarette lighter plug, Flex: DIN plug 	007337001 12 V Fixed Mount
			007337021* 12 V Magnet 006846001 12 V Flex Mount 007337011 24 V Fixed Mount 006846011 24 V Flex Mount



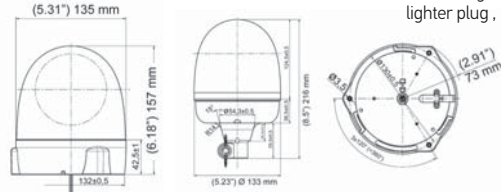

* Special order item

KL ROTA COMPACT 	HALOGEN <ul style="list-style-type: none"> The classic HELLA beacon Fulfills highest legal requirements (SAE J845 Class 1, ECE,...) Modular mounting options to suit all applications 2 year warranty 	<ul style="list-style-type: none"> Voltage: 12 or 24 VDC Flash Pattern: Rotating 180 RPM Approval: SAE J845 Class 1, ECE R65, ECE R10 Color: Amber Power Consumption: 70 / 85 Watt Mounting: Fixed, Flex mount Connection: Fixed mount: 7.5" cable with open wires, Magnet: 10' spiral cable with cigarette lighter plug, Flex: DIN plug 	009506001 12 V Fixed Mount
			009506011 24 V Flex Mount 009506201 12 V Fixed Mount



QUAD WARNING LED SLIM LIGHTHEADS 	LED <ul style="list-style-type: none"> Wrap around side optic for 180° visibility Low and slim profile for discreet mounting Black aluminum base for maximum heat dissipation and durability Reverse polarity protection Weatherproof and vibration resistant design for external use Mounting Options: Surface mount / Stud mount / Bracket mount Sync up to 8 units Quad Color Accessories: 1 Foam, Screws & Brackets 5 year warranty 	<ul style="list-style-type: none"> Voltage: 10-30 VDC Light Source: 16 LEDs Flash Pattern: 22 user selectable flash pattern Approval: SAE J595 Class 1, CA T13, ECE R10 Colors: Red, Blue, White and Amber Lens color: Clear Power Consumption: 18 Watt Housing material: Aluminum Mounting: Screw Connection: 8" cable with open wires 	358118581 Quad Color
---	---	---	-----------------------------

MS6 QUAD LED LIGHTHEADS 	LED <ul style="list-style-type: none"> Black aluminum base for maximum heat dissipation and durability Multiple units can be grouped to flash simultaneously or alternately Weatherproof and vibration resistant design for external use Sync up to 8 units Quad Color 5 year warranty 	<ul style="list-style-type: none"> Voltage: 10-30 VDC Light Source: 24 LEDs Flash Pattern: 22 user selectable flash pattern Approval: SAE J595 Class 1, CA T13, ECE R10 Colors: Red, Blue, White and Amber Lens color: Clear Power Consumption: 18 Watt Housing material: Aluminum Mounting: Screw Connection: 8" cable with open wires 	358118591 Quad Color
---	--	---	-----------------------------

MS6-DC DUAL COLOR LIGHTHEADS 	LED <ul style="list-style-type: none"> Get twice as much for your money - optical warning strobe + worklight all in one Dual Color LED lighthouse with integrated white scene light override function Lighthouse has a comfortable 7 foot installation cable Multiple units can be grouped to flash simultaneously or alternately 5 year warranty 	<ul style="list-style-type: none"> Voltage: 10-30 VDC Light Source: 2x6 LEDs Flash Pattern: 29 user selectable flash pattern Approval: SAE J595 Class 1 Colors: Red, Blue, Amber with White override function Power Consumption: 18 Watt Housing material: Aluminum Mounting: Screw Connection: 7ft cable with open wire 	358118131 Red + Blue split / all White overwrite
			358118141 Amber + White split / all White overwrite 358118151* All Red / all Blue overwrite 358118161* All Red / all White overwrite 358118171* All Blue / all White overwrite

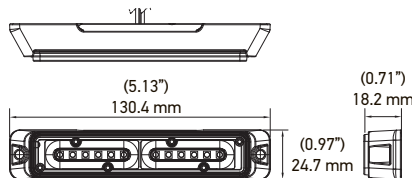

* Special order item

Product image / Dimensions	Features	Technical Specifications	Part Number
<p>MST6E SLIM STROBE LIGHTHEADS</p> 	<p>LED</p> <ul style="list-style-type: none"> • Super low profile for discreet placement • Frosted lens for glowing body technology and 180 degree visibility • 5 year warranty 	<ul style="list-style-type: none"> • Voltage: 10-30 VDC • Light Source: 6 LEDs • Flash Pattern: 21 user selectable flash pattern • Approval: SAE J595 Class 1 • Colors: Amber, Blue, Red, White and Green • Power Consumption: 6 Watt • Housing material: Plastic • Mounting: Screw + 3M tape • Connection: 8" cable with open wires 	<p>358111691 (H22897001) Amber</p> <p>358111701 (H22897011) Blue</p> <p>358111711 (H22897021) White</p> <p>358111721 (H22897031) Red</p> <p>358111731 (H22897041) Green</p> <p>358111741 (H22897051) Amber/White</p> <p>358111771* (H22897081) Green/White</p> <p>* Special order item</p>
<p>CONCEALED LED GEN.II LIGHTHEADS</p> 	<p>LED</p> <ul style="list-style-type: none"> • Reliable LED concealed lighthouse set (2 lights, control unit, long install cables) • Pop-in design for easy installation (can be used as hideaways or for surface mounting) • Synchronized units can flash simultaneously or alternately • 5 year warranty 	<ul style="list-style-type: none"> • Voltage: 10-30 VDC • Light Source: 2x6 LEDs • Flash Pattern: 37user selectable flash pattern • Approval: SAE J595 Class 1 • Colors: Amber, White, A/W and Blue/White • Power Consumption: 12 Watt • Housing material: Aluminum • Mounting: Screw • Connection: 3ft + 10ft cable with easy connectors 	<p>358111941* (H22901001) Amber</p> <p>358111951* (H22901021) White</p> <p>358111961 (H22901031) Amber/White</p> <p>358111971* (H22901041) Blue/White</p> <p>* Special order item</p>
<p>MS6 STROBE LIGHTHEADS</p> 	<p>LED</p> <ul style="list-style-type: none"> • Classic 6 LED warning strobe • Black aluminum base for maximum heat dissipation • Fulfills all legal requirements (SAE J845 Class 1, CT13, ...) • Synchronized units can flash simultaneously or alternately • 5 year warranty 	<ul style="list-style-type: none"> • Voltage: 10-30 VDC • Light Source: 6 LEDs • Flash Pattern: 19 user selectable flash pattern • Approval: SAE J595 Class 1, California Title 13 • Colors: Amber, Blue, Red and White • Power Consumption: 10 Watt • Housing material: Aluminum • Mounting: Screw • Connection: 4" cable with open wires 	<p>358111151 (H22890001) Amber</p> <p>358111161 (H22890021) White</p> <p>358111171 (H22890031) Blue</p> <p>358111181 (H22890041) Red</p> <p>358111191 (H22890051) Amber/White</p> <p>358111201 (H22890061) Red/Blue</p> <p>358111211 (H22890071) Red/White</p>
<p>MST6 SLIM STROBE LIGHTHEADS</p> 	<p>LED</p> <ul style="list-style-type: none"> • Super low profile for discreet placement • Fulfills all legal requirements (SAE J845 Class 1, CT13, ...) • Synchronized units can flash simultaneously or alternately • 5 year warranty 	<ul style="list-style-type: none"> • Voltage: 10-30 VDC • Light Source: 6 LEDs • Flash Pattern: 23 user selectable flash pattern • Approval: SAE J595 Class 1, California Title 13 • Colors: Amber, Blue, Red and White • Power Consumption: 6 Watt • Housing material: Plastic • Mounting: Screw • Connection: 8" cable with open wires 	<p>358111321 (H22895001) Amber</p> <p>358111341 (H22895031) White</p> <p>358111361 (H22895051) Amber/White</p> <p>* Special order item</p>
<p>MS4 TRIPLE COLOR LIGHTHEADS</p> 	<p>LED</p> <ul style="list-style-type: none"> • Triple color LED warning strobe with integrated white scene light override function • Multiple units can be grouped to flash simultaneously or alternately • 5 year warranty 	<ul style="list-style-type: none"> • Voltage: 10-30 VDC • Light Source: 4x3 LEDs • Flash Pattern: 21 user selectable flash pattern (incl. steady on) • Approval: SAE J595 Class 1 • Colors: Red, Blue, Amber, White with White override function • Power Consumption: 18 Watt • Housing material: Aluminum • Mounting: Screw • Connection: 7" cable with open wires 	<p>358111911 (H22899001) Red/White/Blue</p> <p>358111921 (H22899011) Amber/White/Blue</p>



Product image / Dimensions	Features	Technical Specifications	Part Number
----------------------------	----------	--------------------------	-------------

MS3 MINI LED
LIGHTHEADS

LED

- Compact 3 LED warning strobe
- Black aluminum base for maximum heat dissipation
- Fulfills all legal requirements (SAE J845 Class 1, CT13, ...)
- Synchronized units can flash simultaneously or alternately
- 5 year warranty

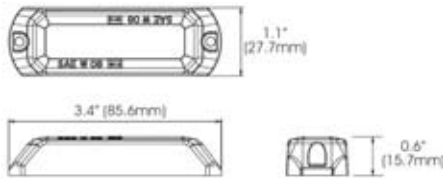

- Voltage: 10-30 VDC
- Light Source: 3 LEDs
- Flash Pattern: 12 user selectable flash pattern
- Approval: SAE J595 Class 1, California Title 13
- Colors: Amber, White
- Power Consumption: 5 Watt
- Housing material: Aluminum
- Mounting: Screw
- Connection: 4" cable with open wires

358111221 (H22891001) Amber

358111241 (H22891031) White

MST3 SLIM STROBE
LIGHTHEADS

LED

- Super compact and low profile flasher for discreet placement
- Fulfills all legal requirements (SAE J845 Class 1, CT13, ...)
- Synchronized units can flash simultaneously or alternately
- 5 year warranty

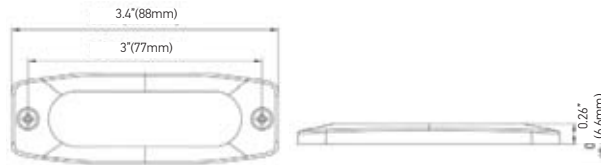

- Voltage: 10-30 VDC
- Light Source: 3 LEDs
- Flash Pattern: 12 user selectable flash pattern
- Approval: SAE J595 Class 1, California Title 13
- Colors: Amber, Blue, Red and White
- Power Consumption: 3 Watt
- Housing material: Plastic
- Mounting: Screw
- Connection: 8" cable with open wires

358111001 (H22896001) Amber

358117131 (H22896041) White

358117121 (H22896031) Red

Find the right product with ease



The purpose of our online information is to provide you with more ways to efficiently and conveniently identify the latest HELLA products and obtain important information about them. No matter what you are looking for, we are sure to have the right product in our range!

- Product information
- Product videos
- 3D animations
- Configuration tools for many Applications
- Interactive applications for phones smart and tablets
- Lighting technology comparisons
- Adjustment recommendations

ELIVER - WORK LIGHTS and OPTICAL WARNING SYSTEMS simulator

This online tool allows you to compare the light distribution of WORK LIGHTS and flash patterns of HELLA products in a realistic environment.



www.hella.com/eliver

90 MM CONFIGURATOR

Just specify the desired voltage, lighting functions and light technologies for your motorhome, and the easy-to-use configurator guides you to the right product from the HELLA 90 mm module series.



<https://www.hella.com/MicroSite/90mm-modules/>

HELLA MINING

The HELLA Mining Center of Excellence was created in Australia in 2002 to design, develop and manufacture lighting products specifically for the mining industry. HELLA uses its research, engineering and logistics expertise to produce lighting products designed to meet world class standards that can be used in mining applications worldwide.

HELLA Mining products meet the needs of mining companies. The concept of "Technology with Vision" highlights the fact that we exceed the expectations of our customers by producing quality products that meet the requirements for the toughest industry on the planet in an efficient, advanced and professional manner, offering real technology with vision to future.



www.hellamining.com

MICROSITE: Find more information about HELLA Mining

MICROSITE: Find more information about HELLA MARINE:



www.hellamarine.com



HELLA MARINE

HELLA MARINE is headquartered in Auckland, New Zealand, a country with a rich maritime history, world class boat building and yacht racing success.

Combining this passion for the ocean with decades of experience in the design of LED products, HELLA MARINE lights are totally compatible and feature functional design, offering total peace of mind, safety and durability at sea. Through research and development, innovative design and the use of high quality materials, HELLA MARINE continues to establish benchmarks for extremely reliable and highly efficient products.

At present, HELLA MARINE is a world-renowned and reliable brand in navigation for its high-performance LED LIGHTING systems, available in more than 60 countries through the HELLA global network and specialized maritime distributors.

ORIGINAL PARTS

Functional safety, a perfect fit and product durability



VEHICLE SPECIFIC LIGHTING

HELLA offers three guarantees with its wide range of lighting products for specific vehicles: better functionality, perfect fit and lasting customer satisfaction. All spare parts are manufactured to the same specifications and quality standards as the parts HELLA manufactures for its customers of original equipment worldwide. Through our technological innovations it allows us to continually develop our range of products such as lamps, taillights and interior lights.

HELLA is a world leader in automotive lighting technology and is a provider of many OE brands. HELLA has helped transform halogen lighting systems to xenon AFS and now to LED matrix systems that make lighting our exclusive technology.



UPDATED!

Find lighting parts for specific vehicles at:



<https://hella.mypartfinder.com/>

HELLA is pleased to announce that it is the first manufacturer to receive CAPA approval to participate in Tier 1 Replacement Parts Verification Program, which is only available to Tier 1 suppliers who also produce an in-house, alternately branded version of car company original (CCO), or car company service (CCS) parts used for automotive repair.



CAPA Tier 1 Verified parts must demonstrate compliance to all applicable federal regulations. These efforts help to ensure there are no differences when a supplier changes production from manufacturing the car company parts to the Tier 1 branded version of the part identified by the CAPA Tier 1 Verified label.

HELLA is a leading supplier to the Collision and General Repair Industry for vehicle-specific lighting with comprehensive market coverage. Thanks to our innovative powers, we're continuously expanding our product range of headlamps, lamps and interior lights.

See verified parts in the following pages.



HELLA - LIT SINCE 1899
<https://youtu.be/QfHTfAZRn3Q>























HELLA LIQUID CRYSTAL HD
THE ART OF LIGHT
<https://youtu.be/pl6rxEmE1g4>



THE HELLA LIGHT TUNNEL
<https://youtu.be/AXlrGxi-kCs>





















HELLA - CAPA TIER 1 VERIFICATION PROGRAM

PN	Image	Make	Model	Year	OE#	PartsLink	COO
010740351		Audi	A3	2014-2016	8V0941043B	AU2502191	CZ
010740361		Audi	A3	2014-2016	8V0941044B	AU2503191	CZ
011150391		Audi	A6 Quattro S6	2011-2014	4G0941043E	AU2502170	CZ
011150401		Audi	A6 Quattro S6	2011-2014	4G0941044E	AU2503170	CZ
011151451		Audi	A6 Quattro S6	2014-2018	4G0941773E	AU2502172	DE
011151461		Audi	A6 Quattro S6	2012-2017	4G0941774E	AU2503172	DE
012976051		Audi	A6 Quattro S6	2016-2016	4G0941043H	AU2502195	CZ
012976061		Audi	A6 Quattro S6	2015-2018	4G0941044H	AU2503195	CZ
012976151		Audi	A6 Quattro S6	2016-2018	4G0941773K	AU2502196	CZ
012976161		Audi	A6 Quattro S6	2016-2016	4G0941774K	AU2503196	CZ
011869351		Audi	A7 Quattro RS7 S7	2016-2018	4G8941773M	AU2502197	DE
011869361		Audi	A7 Quattro RS7 S7	2016-2018	4G8941774M	AU2503197	DE
013375051		Audi	A7 Sportback S7 Sportback	2019-2021	4K8941035B	AU2502231	DE
013375061		Audi	A7 Sportback S7 Sportback	2019-2021	4K8941036B	AU2503231	DE
012863451		Audi	A8 Quattro	2019-2020	4N0941773B	AU2502219	DE
012863461		Audi	A8 Quattro	2019-2020	4N0941774B	AU2503219	DE
012865451		Audi	A8 Quattro	2019-2020	4N0941783B	AU2502215	DE
012865461		Audi	A8 Quattro	2019-2020	4N0941784B	AU2503215	DE
011496451		Audi	A8 Quattro S8	2013-2018	4H0941773	AU2518109	DE
011496461		Audi	A8 Quattro S8	2013-2018	4H0941774	AU2519109	DE
012101951		BMW	320i 320i xDrive 328d 328d xDrive 328i 328i xDrive 330e 330i 330i xDrive 340i 340i xDrive	2015-2018	63117365599	BM2518166	CZ

HELLA - CAPA TIER 1 VERIFICATION PROGRAM

PN	Image	Make	Model	Year	OE#	PartsLink	COO
012101961		BMW	320i 320i xDrive 328d 328d xDrive 328i 328i xDrive 330e 330i 330i xDrive 340i 340i xDrive	2015-2018	63117365600	BM2519166	CZ
012102961		BMW	320i 320i xDrive 328d 328d xDrive 328i 328i xDrive 330e 330i 340i 340i xDrive	2015-2018	63117419630	BM2503187	CZ
012103951		BMW	320i 320i xDrive 328d 328d xDrive 328i 328i xDrive 330e 330i 340i 340i xDrive	2015-2018	63117419621	BM2502188	CZ
012103961		BMW	320i 320i xDrive 328d 328d xDrive 328i 328i xDrive 330e 330i 340i 340i xDrive	2015-2018	63117419622	BM2503188	CZ
012102951		BMW	320i 320i xDrive 328d 328d xDrive 328i 328i xDrive 330e 330i 340i xDrive	2015-2018	63117419629	BM2502187	CZ
011087951		BMW	528i 528i xDrive 535d 535d xDrive 535i 535i xDrive 550 550i xDrive ActiveHybrid 5 M5	2014-2016	63117343905	BM2518159	DE
011087961		BMW	528i 528i xDrive 535d 535d xDrive 535i 535i xDrive 550 550i xDrive ActiveHybrid 5 M5	2014-2016	63117343906	BM2519159	DE
011072951		BMW	528i 528i xDrive 535d 535d xDrive 535i 535i xDrive 550 550i xDrive M5	2012-2017	63117352485	BM2518150	DE
011072961		BMW	528i 528i xDrive 535d 535d xDrive 535i 535i xDrive 550 550i xDrive M5	2012-2017	63117352486	BM2519150	DE
010131051		BMW	528i 528i xDrive 535i 535i xDrive 550i 550i xDrive M5	2009-2013	63117203243	BM2502174	DE
010131061		BMW	528i 528i xDrive 535i 535i xDrive 550i 550i xDrive M5	2009-2013	63117203244	BM2503174	DE
010131651		BMW	528i 528i xDrive 535i 535i xDrive 550i 550i xDrive M5	2011-2013	63117271903	BM2502173	DE
010131661		BMW	528i 528i xDrive 535i 535i xDrive 550i 550i xDrive M5	2011-2013	63117271904	BM2503173	DE
015449451		BMW	530i 540i M5 M550i xDrive	2021-2022	63119479265	BM2502201	CZ
015449461		BMW	530i 540i M5 M550i xDrive	2021-2022	63119479266	BM2503201	CZ
009934451		BMW	Z4	2009-2013	63127228867	BM2518129	DE
009934461		BMW	Z4	2009-2013	63127228868	BM2519129	DE
247005011		Dodge	Sprinter 2500 Sprinter 3500	2003-2006	9018203361 5124526AA	CH2502172	SK
247005021		Dodge	Sprinter 2500 Sprinter 3500	2003-2006	9018203461 5124528AA	CH2503172	SK





















HELLA - CAPA TIER 1 VERIFICATION PROGRAM

PN	Image	Make	Model	Year	OE#	PartsLink	COO
015091851		Mercedes -Benz	A220	2019-2020	1779060501	MB2502263	SK
015091861		Mercedes -Benz	A220	2019-2020	1779060601	MB2503263	SK
015091951		Mercedes -Benz	A220	2019-2020	1779060104	MB2502267	SK
015091961		Mercedes -Benz	A220	2019-2020	1779060204	MB2503267	SK
013063551		Mercedes -Benz	C300 C63 AMG C63 AMG S	2019-2020	2059066004	MB2518113	SK
013063561		Mercedes -Benz	C300 C63 AMG C63 AMG S	2019-2020	2059066104	MB2519113	SK
013063651		Mercedes -Benz	C300 C63 AMG C63 AMG S	2019-2019	2059066604	MB2518114	SK
013063661		Mercedes -Benz	C300 C63 AMG C63 AMG S	2019-2019	2059066704	MB2519114	SK
013074651		Mercedes -Benz	GLA250 GLA35 AMG GLA45 AMG	2021-2022	2479068101	MB2502275	CZ
013074661		Mercedes -Benz	GLA250 GLA35 AMG GLA45 AMG	2021-2022	2479068201	MB2503275	CZ
015086551		Mercedes -Benz	CLA250 CLA35 AMG CLA45 AMG	2020-2021	1189069500	MB2502266	SK
015086561		Mercedes -Benz	CLA250 CLA35 AMG CLA45 AMG	2020-2021	1189069600	MB2503266	SK
015086351		Mercedes -Benz	CLA250 CLA45 AMG	2019-2020	1189064300	MB2502265	SK
015086361		Mercedes -Benz	CLA250 CLA45 AMG	2019-2020	1189064400	MB2503265	SK
015619651		Mercedes -Benz	CLS450 CLS53 AMG	2020-2021	2579064302	MB2502279	DE
015619661		Mercedes -Benz	CLS450 CLS53 AMG	2020-2021	2579064402	MB2503279	DE
015619751		Mercedes -Benz	CLS450 CLS53 AMG	2020-2021	2579064902	MB2502280	DE
015619761		Mercedes -Benz	CLS450 CLS53 AMG	2020-2021	2579065002	MB2503280	DE
015619851		Mercedes -Benz	CLS450 CLS53 AMG	2019-2021	2579061700	MB2502277	DE
015619861		Mercedes -Benz	CLS450 CLS53 AMG	2019-2020	2579061800	MB2503277	DE
015619951		Mercedes -Benz	CLS450 CLS53 AMG	2019-2019	2579062300	MB2502278	DE

HELLA - CAPA TIER 1 VERIFICATION PROGRAM

PN	Image	Make	Model	Year	OE#	PartsLink	COO
015619961		Mercedes -Benz	CLS450 CLS53 AMG	2019-2019	2579062400	MB2503278	DE
014215351		Mercedes -Benz	E200 E300 E350 E43 AMG E450 E53 AMG E63 AMG E63 AMG S	2020-2020	2139066708	MB2502274	SK
014215361		Mercedes -Benz	E200 E300 E350 E43 AMG E450 E53 AMG E63 AMG E63 AMG S	2020-2020	2139063610	MB2503274	SK
014215431		Mercedes -Benz	E200 E300 E350 E350e E43 AMG E450 E53 AMG E63 AMG E63 AMG S	2020-2022	2139067308	MB2502281	SK
014215441		Mercedes -Benz	E200 E300 E350 E350e E43 AMG E450 E53 AMG E63 AMG E63 AMG S	2020-2022	2139067408	MB2503281	SK
009647971		Mercedes -Benz	E250 E300 E350 E500 E550	2010-2013	2078205361	MB2502190	SI
009647981		Mercedes -Benz	E250 E300 E350 E500 E550	2010-2013	207820546164	MB2503190	SI
011066651		Mercedes -Benz	E250 E350 E400 E550 E63 AMG E63 AMG S	2014-2016	212820213964	MB2502219	DE
011066661		Mercedes -Benz	E250 E350 E400 E550 E63 AMG E63 AMG S	2014-2016	2128202239	MB2503219	DE
011066711		Mercedes -Benz	E250 E350 E400 E550 E63 AMG E63 AMG S	2014-2016	2128202739	MB2502240	DE
011066721		Mercedes -Benz	E250 E350 E400 E550 E63 AMG E63 AMG S	2014-2016	2128202839	MB2503240	DE
012076551		Mercedes -Benz	E300 E43 AMG	2016-2019	2139066901	MB2518110	SK
012076561		Mercedes -Benz	E300 E43 AMG	2016-2019	2139067001	MB2519110	SK
012076651		Mercedes -Benz	E300 E43 AMG	2016-2019	2139069704	MB2518111	DE
012076661		Mercedes -Benz	E300 E43 AMG	2016-2019	2139069804	MB2519111	DE
011091851		Mercedes -Benz	E400 E550	2013-2016	2078208961	MB2502233	DE
011091861		Mercedes -Benz	E400 E550	2013-2016	2078209061	MB2503233	DE
271531111		Mercedes -Benz	G500 G55 AMG G550 G63 AMG G65 AMG	2007-2016	4638200759	MB2502260	SI
013074751		Mercedes -Benz	GLA250 GLA35 AMG GLA45 AMG	2021-2022	2479068701	MB2502271	CZ
013074761		Mercedes -Benz	GLA250 GLA35 AMG GLA45 AMG	2021-2022	2479068801	MB2503271	CZ





















HELLA - CAPA TIER 1 VERIFICATION PROGRAM

PN	Image	Make	Model	Year	OE#	PartsLink	COO
011284551		Mercedes -Benz	Metris	2016-2016	4478200861	MB2502241	SK
011284561		Mercedes -Benz	Metris	2016-2016	4478200961	MB2503241	SK
011284851		Mercedes -Benz	Metris	2016-2020	4479068100	MB2502264	SK
011284861		Mercedes -Benz	Metris	2016-2020	4479068200	MB2503264	SK
263037051		Mercedes -Benz	R320 R350 R500 R63 AMG	2006-2010	251820036165	MB2502154	SK
263037061		Mercedes- Benz	R320 R350 R500 R63 AMG	2006-2010	251820046165	MB2503154	SK
263037351		Mercedes -Benz	R320 R350 R500 R63 AMG	2006-2010	251820236164	MB2502179	SK
263037361		Mercedes -Benz	R320 R350 R500 R63 AMG	2006-2010	2518202461	MB2503179	SK
008361651		Mercedes -Benz	SLK280 SLK300 SLK350	2005-2011	171820356164	MB2502165	SK
008361661		Mercedes -Benz	SLK280 SLK300 SLK350	2005-2011	171820366164	MB2503165	SK
247012091		Mercedes -Benz	Sprinter	2010-2012	906820156164	MB2502191	SK
247012101		Mercedes -Benz	Sprinter	2010-2012	9068201661	MB2503191	SK
247012251		Mercedes -Benz	Sprinter	2010-2012	9068202061	MB2502205	SK
247012261		Mercedes -Benz	Sprinter	2010-2012	9068202161	MB2503205	SK
011030151		Mercedes -Benz	Sprinter 2500	2014-2016	906820600064	MB2502221	SK
011030161		Mercedes -Benz	Sprinter 3500	2014-2016	906820610064	MB2503221	SK
011745771		Porsche	Cayenne	2015-2018	958941753F	PO2518103	DE
011745781		Porsche	Cayenne	2015-2018	958941754F	PO2519103	DE
011099531		Porsche	Panamera	2013-2016	97063116974	PO2502134	DE
011099541		Porsche	Panamera	2013-2016	97063117074	PO2503134	DE
001149011		Volkswagen	Beetle	1950-1967	111941039A	VW2502181	CZ

HELLA - CAPA TIER 1 VERIFICATION PROGRAM

PN	Image	Make	Model	Year	OE#	PartsLink	COO
010793151		Volkswagen	Beetle	2012-2016	5C1941005	VW2502147	MX
010793161		Volkswagen	Beetle	2012-2016	5C1941006	VW2503147	MX
010793351		Volkswagen	Beetle	2012-2013	5C1941031B	VW2502150	MX
010793361		Volkswagen	Beetle	2012-2013	5C1941032B	VW2503150	MX
010793751		Volkswagen	Beetle	2014-2016	5C1941031H	VW2502157	MX
010793761		Volkswagen	Beetle	2014-2016	5C1941032H	VW2503157	MX
009901251		Volkswagen	Golf GTI	2010-2013	5K0941005C	VW2502144	CZ
009901261		Volkswagen	Golf GTI	2010-2013	5K0941006C	VW2503144	CZ
247007351		Volkswagen	GTI Jetta Rabbit	2005-2010	1K6941005S	VW2502127	MX
247007361		Volkswagen	GTI Jetta Rabbit	2005-2010	1K6941006S	VW2503127	MX
010310071		Volkswagen	Jetta	2010-2014	5K0941005D	VW2502145	MX
010310081		Volkswagen	Jetta	2010-2014	5K0941006D	VW2503145	MX
010748351		Volkswagen	Tiguan	2012-2018	5N0941753B	VW2502155	CZ
010748361		Volkswagen	Tiguan	2012-2018	5N0941754B	VW2503155	CZ
010749251		Volkswagen	Tiguan	2012-2018	5N0941005	VW2502152	CZ
010749261		Volkswagen	Tiguan	2012-2018	5N0941006	VW2503152	CZ
009452171		Volkswagen	Touareg	2008-2010	7L6941039E	VW2502140	CZ
009452181		Volkswagen	Touareg	2008-2010	7L6941040E	VW2503140	CZ
011937451		Volkswagen	Touareg	2015-2017	7P0941753	VW2518120	CZ
011937461		Volkswagen	Touareg	2015-2017	7P0941754	VW2519120	CZ



HELLA - TIER 1

PN	Image	Make	Model	Year	OE#	PartsLink	COO
007878041		Audi	A4 A4 Quattro	1999-2002	1J0941295B	TBA	DE
009701151		Audi	A6	2004-2008	4F0941029EK	AU2502122	CZ
009701161		Audi	A6	2004-2008	4F0941030EK	AU2503122	CZ
354839091		Audi	Q3 Q3 Quattro	2015-2018	8U0941043F	AU2518107	AT
354839101		Audi	Q3 Q3 Quattro	2015-2018	8U0941044F	AU2519107	AT
354839211		Audi	Q3 Q3 Quattro	2015-2018	8U0941453	AU2508110	AT
354839221		Audi	Q3 Q3 Quattro	2015-2018	8U0941454	AU2509110	AT
354840051		Audi	Q3 Q3 Quattro	2015-2018	8U0941043E	AU2502205	AT
354840061		Audi	Q3 Q3 Quattro	2015-2018	8U0941044E	AU2503205	AT
354841051		Audi	Q7	2017-2019	4M0941043E	AU2502201	AT
354841061		Audi	Q7	2017-2019	4M0941044E	AU2503201	AT
354841091		Audi	Q7	2017-2019	4M0941773E	AU2502202	AT
354841101		Audi	Q7	2017-2019	4M0941774E	AU2503202	AT
354870051		Audi	Q3 RS Q3	2019-2022	83A941011B	AU2502222	AT
354870061		Audi	Q3 RS Q3	2019-2022	83A941012B	AU2503222	AT
354870111		Audi	Q3 RS Q3	2019-2022	83A941773B	AU2502227	AT
354870121		Audi	Q3 RS Q3	2019-2022	83A941774B	AU2503227	AT
354871051		Audi	Q8 RS Q8	2019-2022	4M8 941 773 E	AU2502230	AT
354871061		Audi	Q8 SQ8	2019-2022	4M8 941 774 E	AU2503230	AT
354881051		Audi	Q7 SQ7	2020-2022	4M0 941 011 E	AU2502228	AT
354881061		Audi	Q7 SQ7	2020-2022	4M0 941 012 E	AU2503228	AT

HELLA - TIER 1

PN	Image	Make	Model	Year	OE#	PartsLink	COO
354881111		Audi	Q7 SQ7	2020-2022	4M0 941 039 B	AU2502229	AT
354881121		Audi	Q7 SQ7	2020-2022	4M0 941 040 B	AU2503229	AT
008052051		BMW	525i 530i 540i M5	2001-2003	63126912433	BM2502115	CZ
008052061		BMW	525i 530i 540i M5	2001-2003	63126912434	BM2503115	CZ
008052111		BMW	525i 530i 540i M5	2001-2003	63126912439	BM2502116	CZ
008052121		BMW	525i 530i 540i M5	2001-2003	63126912440	BM2503116	CZ
008053051		BMW	525i 530i 540i	2001-2003	63126900199	BM2502120	CZ
008053061		BMW	525i 530i 540i	2001-2003	63126900200	BM2503120	CZ
008053111		BMW	525i 530i 540i	2001-2003	63126902517	BM2502121	CZ
008053121		BMW	525i 530i 540i	2001-2003	63126902518	BM2503121	CZ
008673111		BMW	525i 525xi 530i 530xi 545i 550i	2004-2007	63127166115	BM2502134	CZ
008673121		BMW	525i 525xi 530i 530xi 545i 550i	2004-2007	63127166116	BM2503133	CZ
009449051		BMW	528i 528i xDrive 528xi 535i 535i xDrive 535xi 550i	2008-2010	63127177731	BM2502142	CZ
009449061		BMW	528i 528i xDrive 528xi 535i 535i xDrive 535xi 550i	2008-2010	63127177732	BM2503142	CZ
160291011		BMW	525i 530i 545i	2004-2005	63127166119	BM2518167	CZ
160292011		BMW	525i 530i 545i	2004-2005	63127166120	BM2519167	CZ
164911001		BMW	528i 528i xDrive 528xi 535i 535i xDrive 535xi 550i M5	2008-2010	63127177755	BM2502150	CZ
164912001		BMW	528i 528i xDrive 528xi 535i 535i xDrive 535xi 550i M5	2008-2010	63127177756	BM2503150	CZ
169009151		BMW	528i 528xi 535i 535xi 550i M5	2006-2010	63127045695	BM2518122	CZ
169009161		BMW	528i 528xi 535i 535xi 550i M5	2006-2010	63127045696	BM2519122	CZ
224485341		BMW	X5	2003-2006	63117166800	BM2519127	DE

HELLA - TIER 1

PN	Image	Make	Model	Year	OE#	PartsLink	COO
224486031		BMW	X5	2004-2006	63127164423	BM2518146	DE
224486041		BMW	X5	2004-2006	63127164424	BM2519146	DE
247000051		BMW	Z4	2003-2006	63127165653	BM2518115	RO
247000061		BMW	Z4	2003-2006	63127165654	BM2519115	RO
247001551		BMW	Z4	2003-2009	63127165701	BM2518113	RO
247001561		BMW	Z4	2003-2009	63127165702	BM2519113	RO
354688051		BMW	323i 325i 325xi 328i 328xi 330i 330xi 335i 335xi	2006-2008	63117161669	BM2502140	AT
354688061		BMW	323i 325i 325xi 328i 328xi 330i 330xi 335i 335xi	2006-2008	63117161670	BM2503140	AT
354690051		BMW	740i 740Li 740Li xDrive 750i 750i xDrive 750Li 750Li xDrive 760Li	2009-2013	63117228423	BM2518168	AT
354690061		BMW	740i 740Li 750i 750i xDrive 750Li 750Li xDrive 760Li	2009-2012	63117228424	BM2519168	AT
354692051		BMW	323i 325i 328i 328i xDrive 335d 335i 335i xDrive	2009-2012	63117240261	BM2502154	AT
354692061		BMW	323i 325i 328i 328i xDrive 335d 335i 335i xDrive	2009-2012	63117240262	BM2503154	AT
354836091		BMW	530e 530e xDrive 530i 530i xDrive 540d xDrive 540i 540i xDrive M5 M550i xDrive	2017-2020	63117214959	BM2518179	AT
354836101		BMW	530e 530e xDrive 530i 530i xDrive 540d xDrive 540i 540i xDrive M550i xDrive	2017-2020	63117214960	BM2519179	AT
354836151		BMW	530e 530e xDrive 530i 530i xDrive 540d xDrive 540i 540i xDrive M5 M550i xDrive	2017-2019	63117214965	BM2502189	AT
354836161		BMW	530e 530e xDrive 530i 530i xDrive 540d xDrive 540i 540i xDrive M5 M550i xDrive	2017-2019	63117214966	BM2503189	AT
354854091		BMW	740e xDrive 740i 740i xDrive 750i 750i xDrive Alpina B7 M760i xDrive	2016-2020	63117408711	BM2518181	AT
354854101		BMW	740e xDrive 740i 740i xDrive 750i 750i xDrive Alpina B7 M760i xDrive	2016-2020	63117408712	BM2519181	AT
354854151		BMW	740e xDrive 740i 740i xDrive 750i 750i xDrive Alpina B7 M760i xDrive	2016-2019	63117408705	BM2518172	AT
354854161		BMW	740e xDrive 740i 740i xDrive 750i 750i xDrive Alpina B7 M760i xDrive	2016-2019	63117408706	BM2519172	AT



HELLA - TIER 1

PN	Image	Make	Model	Year	OE#	PartsLink	COO
354983051		BMW	320i 320i xDrive 328d 328d xDrive 328i 328i xDrive 335 335i xDrive ActiveHybrid 3	2012-2014	63117338709	BM2502169	AT
354983061		BMW	320i 320i xDrive 328d 328d xDrive 328i 328i xDrive 335 335i xDrive ActiveHybrid 3	2012-2014	63117338710	BM2503169	AT
354983151		BMW	320i 320i xDrive 328d 328d xDrive 328i 328i xDrive 335 335i xDrive ActiveHybrid 3	2012-2014	63117338705	BM2502181	AT
354983251		BMW	320i 320i xDrive 328d 328d xDrive 328i 328i xDrive 335 335i xDrive ActiveHybrid 3	2012-2014	63117338707	BM2502175	AT
354983261		BMW	320i 320i xDrive 328d 328d xDrive 328i 328i xDrive 335 335i xDrive ActiveHybrid 3	2012-2014	63117338708	BM2503175	AT
H11077021		BMW	525i 525xi 530i 530xi 545i 550i M5	2005-2007	63127160158	BM2503124	CZ
H11077031		BMW	525i 525xi 530i 530xi 545i 550i M5	2005-2007	63127160157	BM2502124	CZ
354869091		Buick	Regal Sportback Regal TourX	2018-2020	39209174	GM2502518	AT
354869101		Buick	Regal Sportback Regal TourX	2018-2020	39209175	GM2503518	AT
354869151		Buick	Regal Sportback Regal TourX	2019-2020	39217215	GM2502519	AT
354869161		Buick	Regal Sportback Regal TourX	2019-2020	39217216	GM2503519	AT
007988351		Mercedes-Benz	C55 AMG CLK320 CLK350 CLK500 CLK55 AMG	2003-2006	2098200561	MB2502173	SK
007988361		Mercedes-Benz	C55 AMG CLK320 CLK350 CLK500 CLK55 AMG	2003-2006	2098200661	MB2503173	SK
007988551		Mercedes-Benz	CLK350 CLK500 CLK55 AMG CLK550 CLK63 AMG	2006-2009	2098204161	MB2502109	SK
007988561		Mercedes-Benz	CLK350 CLK500 CLK55 AMG CLK550 CLK63 AMG	2006-2009	209820426164	MB2503109	SK
008369051		Mercedes-Benz	E320 E350 E500 E55 AMG	2003-2006	2118200361	MB2502108	SK
008369061		Mercedes-Benz	E320 E350 E500 E55 AMG	2003-2006	2118200461	MB2503108	SK
008369351		Mercedes-Benz	E320 E500 E55 AMG	2003-2009	2118202361	MB2502124	SK
008369361		Mercedes-Benz	E320 E500 E55 AMG	2003-2006	2118202461	MB2503124	SK



















HELLA - TIER 1

PN	Image	Make	Model	Year	OE#	PartsLink	COO
008369451		Mercedes -Benz	E320 E500 E55 AMG	2003-2008	2118201761	MB2502107	SK
008369461		Mercedes -Benz	E320 E500 E55 AMG	2003-2008	2118201861	MB2503107	SK
008821051		Mercedes -Benz	CLS500 CLS55 AMG CLS550	2006-2011	219820416164	MB2502168	SK
008821061		Mercedes -Benz	CLS500 CLS55 AMG CLS550	2006-2011	219820426164	MB2503168	SK
008821351		Mercedes -Benz	CLS500 CLS55 AMG CLS550	2005-2010	219820436164	MB2502147	SK
008821361		Mercedes -Benz	CLS500 CLS55 AMG CLS550	2005-2010	219820446164	MB2503147	SK
009040351		Mercedes -Benz	CLK320 CLK350 CLK500 CLK55 AMG CLK550 CLK63 AMG	2003-2009	2098201961	MB2502164	SK
009040361		Mercedes -Benz	CLK320 CLK350 CLK500 CLK55 AMG CLK550 CLK63 AMG	2003-2009	2098202061	MB2503164	SK
009260051		Mercedes -Benz	E280 E300 E320 E350 E500 E550 E63 AMG	2006-2009	2118203361	MB2500100	SK
009260061		Mercedes -Benz	E280 E300 E320 E350 E500 E550 E63 AMG	2006-2009	211820346164	MB2501100	SK
009260651		Mercedes -Benz	E320 E350	2007-2009	2118205361	MB2502174	SK
009260661		Mercedes -Benz	E320 E350	2007-2009	2118205461	MB2503174	SK
010800071		Mercedes -Benz	E200 E250 E300 E350 E400 E500 E550 E63 AMG	2010-2013	2128209561	MB2502182	SI
010800081		Mer- cedes-Benz	E200 E250 E300 E350 E400 E500 E550 E63 AMG	2010-2013	2128209661	MB2503182	SI
011705131		Mercedes -Benz	E300 E350 E400 E550	2010-2013	2128201139	MB2502183	SI
011705141		Mercedes -Benz	E300 E350 E400 E550	2010-2013	2128201239	MB2503183	SI
263036051		Mercedes -Benz	ML320 ML350 ML500	2006-2008	164820456165	MB2502146	SK
263036061		Mercedes -Benz	ML320 ML350 ML500	2006-2008	164820386165	MB2503146	SK
263036351		Mercedes -Benz	ML320 ML350 ML500 ML63 AMG	2006-2007	164820516165	MB2502207	SK
263036361		Mercedes -Benz	ML320 ML350 ML500 ML63 AMG	2006-2007	164820226165	MB2503207	SK
263036451		Mercedes -Benz	ML320 ML350 ML500 ML63 AMG	2008-2008	164820216164	MB2502158	SK

HELLA - TIER 1

PN	Image	Make	Model	Year	OE#	PartsLink	COO
263036461		Mercedes -Benz	ML320 ML350 ML550 ML63 AMG	2008-2008	164820226165	MB2503158	SK
263036551		Mercedes -Benz	ML320 ML350 ML450 ML500 ML550 ML63 AMG	2006-2011	1648206161	MB2502170	SK
263036561		Mercedes -Benz	ML320 ML350 ML450 ML500 ML550 ML63 AMG	2006-2011	164820626164	MB2503170	SK
263064051		Mercedes -Benz	ML320 ML350 ML450 ML550 ML63 AMG	2008-2011	164820235964	MB2502171	SK
263064061		Mercedes -Benz	ML320 ML350 ML450 ML550 ML63 AMG	2008-2011	164820245964	MB2503171	SK
263064451		Mercedes -Benz	ML320 ML350 ML450 ML500 ML550 ML63 AMG	2008-2011	164820756164	MB2502172	SK
263064461		Mercedes -Benz	ML320 ML350 ML450 ML500 ML550 ML63 AMG	2008-2011	164820766164	MB2503172	SK
263064551		Mercedes -Benz	ML320 ML350 ML500 ML550 ML63 AMG	2009-2011	1648203559	MB2502181	SK
263064561		Mercedes -Benz	ML320 ML350 ML500 ML550 ML63 AMG	2009-2011	1648203659	MB2503181	SK
263400051		Mercedes -Benz	GL320 GL350 GL450 GL550	2007-2010	164820475964	MB2502202	SK
263400061		Mercedes -Benz	GL320 GL350 GL450 GL550	2007-2010	164820485964	MB2503202	SK
263400351		Mer- cedes-Benz	GL320 GL450	2007-2007	164820356165	MB2502157	SK
263400361		Mercedes -Benz	GL320 GL450	2007-2007	164820366165	MB2503157	SK
263400451		Mercedes -Benz	GL320 GL450	2007-2007	164820456165	MB2502247	SK
263400461		Mercedes -Benz	GL320 GL450	2007-2007	1648204461	MB2503247	SK
263400851		Mercedes -Benz	GL350 GL450 GL500 GL550	2010-2012	164820495964	MB2502204	SK
263400861		Mercedes -Benz	GL350 GL450 GL500 GL550	2010-2012	164820505964	MB2503204	SK
354877051		Mercedes -Benz	GLC250 GLC300 GLC300e GLC350e GLC43 AMG GLC63 AMG GLC63 AMG S	2016-2021	2538201961	MB2502244	AT
354877061		Mercedes -Benz	GLC250 GLC300 GLC300e GLC350e GLC43 AMG GLC63 AMG GLC63 AMG S	2016-2021	2538202061	MB2503244	AT
354877131		Mercedes -Benz	GLC250 GLC300 GLC300e GLC350e GLC43 AMG GLC63 AMG GLC63 AMG S	2016-2021	2539061901	MB2518108	AT

HELLA - TIER 1

PN	Image	Make	Model	Year	OE#	PartsLink	COO
354877141		Mercedes -Benz	GLC250 GLC300 GLC300e GLC350e GLC43 AMG GLC63 AMG GLC63 AMG S	2016-2021	2539062001	MB2519108	AT
354877211		Mercedes -Benz	GLC250 GLC300 GLC300e GLC350e GLC43 AMG GLC63 AMG GLC63 AMG S	2016-2021	2539061301	MB2518109	AT
354877221		Mercedes -Benz	GLC250 GLC300 GLC300e GLC350e GLC43 AMG GLC63 AMG GLC63 AMG S	2016-2021	2539061401	MB2519109	AT
354878031		Mercedes -Benz	GLK250 GLK300 GLK350	2012-2015	2048207259	MB2502194	AT
354878041		Mercedes -Benz	GLK250 GLK280 GLK300 GLK350	2009-2015	2048207359	MB2503194	AT
354878071		Mercedes -Benz	GLK280 GLK300 GLK350	2009-2011	204 820 92 59	MB2502194	AT
354878081		Mercedes -Benz	GLK280 GLK300 GLK350	2009-2011	204 820 93 59	MB2503194	AT
354878151		Mercedes -Benz	GLK250 GLK300 GLK350	2012-2015	2048202739	MB2502236	AT
354878161		Mercedes -Benz	GLK250 GLK300 GLK350	2012-2015	2048202639	MB2503236	AT
354880051		Mercedes -Benz	CLA180 CLA200 CLA250	2016-2019	1179061001	MB2502258	SK
354880061		Mercedes -Benz	CLA180 CLA200 CLA250	2016-2019	1179061101	MB2503258	SK
008350051		Volkswagen	Passat	2001-2005	3B0941015AQ	VW2502118	SK
008350061		Volkswagen	Passat	2001-2005	3B0941016AQ	VW2503118	SK
010395351		Volkswagen	Jetta	2011-2016	5C7941005	VW2502146	MX
010395361		Volkswagen	Jetta	2011-2016	5C7941006	VW2503146	MX
011192231		Volkswagen	Jetta	2013-2014	5C7941751D	VW2502153	MX
011192241		Volkswagen	Jetta	2013-2014	5C7941752D	VW2503153	MX
011956231		Volkswagen	e-Golf Golf	2015-2016	5GM941005C	VW2502160	MX
011956241		Volkswagen	e-Golf Golf	2015-2016	5GM941006C	VW2503160	MX
011956251		Volkswagen	Golf	2015-2016	5GM941753D	VW2518121	MX



HELLA - TIER 1

PN	Image	Make	Model	Year	OE#	PartsLink	COO
011956261		Volkswagen	Golf	2015-2016	5GM941754D	VW2519121	MX
011956271		Volkswagen	Golf	2013-2020	5GM941753A	VW2518117	MX
011956281		Volkswagen	Golf	2013-2020	5GM941754A	VW2519117	MX
012647091		Volkswagen	Jetta	2017-2018	5C7941005J	VW2502168	MX
012647101		Volkswagen	Jetta	2017-2018	5C7941006J	VW2503168	MX
247014061		Volkswagen	Passat	2005-2010	3C0941006AE	VW2503134	CZ
903826001		Volkswagen	Beetle Campmobile Fast-back Squareback Transporter	1966-1979	311941177	VW2512101	AU



True tried and tested by major European car makers for over 125 years, OE quality is in our DNA.



Humidity and cold test



Heat test



Vibration test



Dust test



Immersion and leak test



Pressure washer test

HELLA *VALUEFIT*



VEHICLE SPECIFIC LIGHTING







HELLA has introduced its ValueFit headlamps expanding its product offerings in the automotive aftermarket. These headlamps provide a high-quality, affordable vehicle solution with a focus on Fast Mover Asian Applications. Hella ValueFit headlamps are manufactured according to Hella's strict specifications, standards, and validation processes, ensuring they meet the company's renowned quality requirements.

The products are branded under the Hella ValueFit name, with the logo present on the product itself, labels, and packaging, aligning with the trusted Hella brand.

APPLICATION EXAMPLE



HELLA VALUEFIT HEADLIGHT ASSEMBLY

Product Image	Part Number	Year	Make	Model	OE #	PartsLink #
NEW 	354888021	2018-2018	Toyota	Camry	81110-06C40	T02503255
NEW 	354888011	2018-2018	Toyota	Camry	81150-06C40	T02502255
NEW 	354888031	2019-2020	Toyota	Camry	81150-06C41	T02502277
NEW 	354888041	2019-2020	Toyota	Camry	81110-06C41	T02503277
NEW 	354888051	2018-2018	Toyota	Camry	81150-06D70	T02502256
NEW 	354888061	2018-2018	Toyota	Camry	81110-06D70	T02503256
NEW 	354888071	2018-2018	Toyota	Camry	81150-06D80	T02502257
NEW 	354888081	2018-2018	Toyota	Camry	81110-06D80	T02503257



HELLA

THE LIGHTING EXPERT

OUR EXPERIENCE FOR YOUR SUCCESS



**125 YEARS
OF INNOVATION**

**BEST IN CLASS IN
LIGHTING DESIGN**



**QUALITY WITHOUT
COMPROMISE**

**CERTIFIED LIGHT
SOURCES**



**VEHICLE SPECIFIC
LIGHTING
ELECTRONICS**

HELLA-tested quality

Lippstadt light channel



Geometric measurement

The filament geometry is tested in a measuring projector – in relation to the legal standards according to IEC 60810. The size of the filament and its positioning in the bulb must comply with the provisions of the standard. This is the only way to achieve optimum performance of the lamps and prevent dazzling oncoming traffic.



Vibration and shock test

In this test, the vibration resistance of the bulb and especially of the filament is tested on an electrodynamic vibration test rig.



Lifetime test

In extensive tests, the high reliability of HELLA bulbs is proven over a long period of time.

Europe's longest light tunnel is based at HELLA in Lippstadt, Germany. With a length of 140 metres, the light channel is a unique place to carry out extensive and complex light tests.



Paint adhesion test

In a climate chamber, the adhesion of the lacquer coating of colour lacquered glass bulbs – such as the PY21W – is tested at different temperatures and humidity levels.

The optimal adhesion of the glass bulb coating ensures the required amber direction indicator light over the entire service life.

Luminous flux measurement

The luminous flux and luminous intensities of HELLA bulbs are determined in the integrating sphere and with the goniometer. This ensures the optimum luminous efficacy of the bulbs.

Compliance with world-leading standards



Light explained

The human eye

Discomfort & anxiety

We drive at night because we HAVE to.
But are we well equipped for it?



No glare



Simulated glare

Light & speed

Did you know? Speed leads to a reduction in the field of vision.



Field of vision: 100°



Field of vision: 75°



Field of vision: 45°



Field of vision: 30°

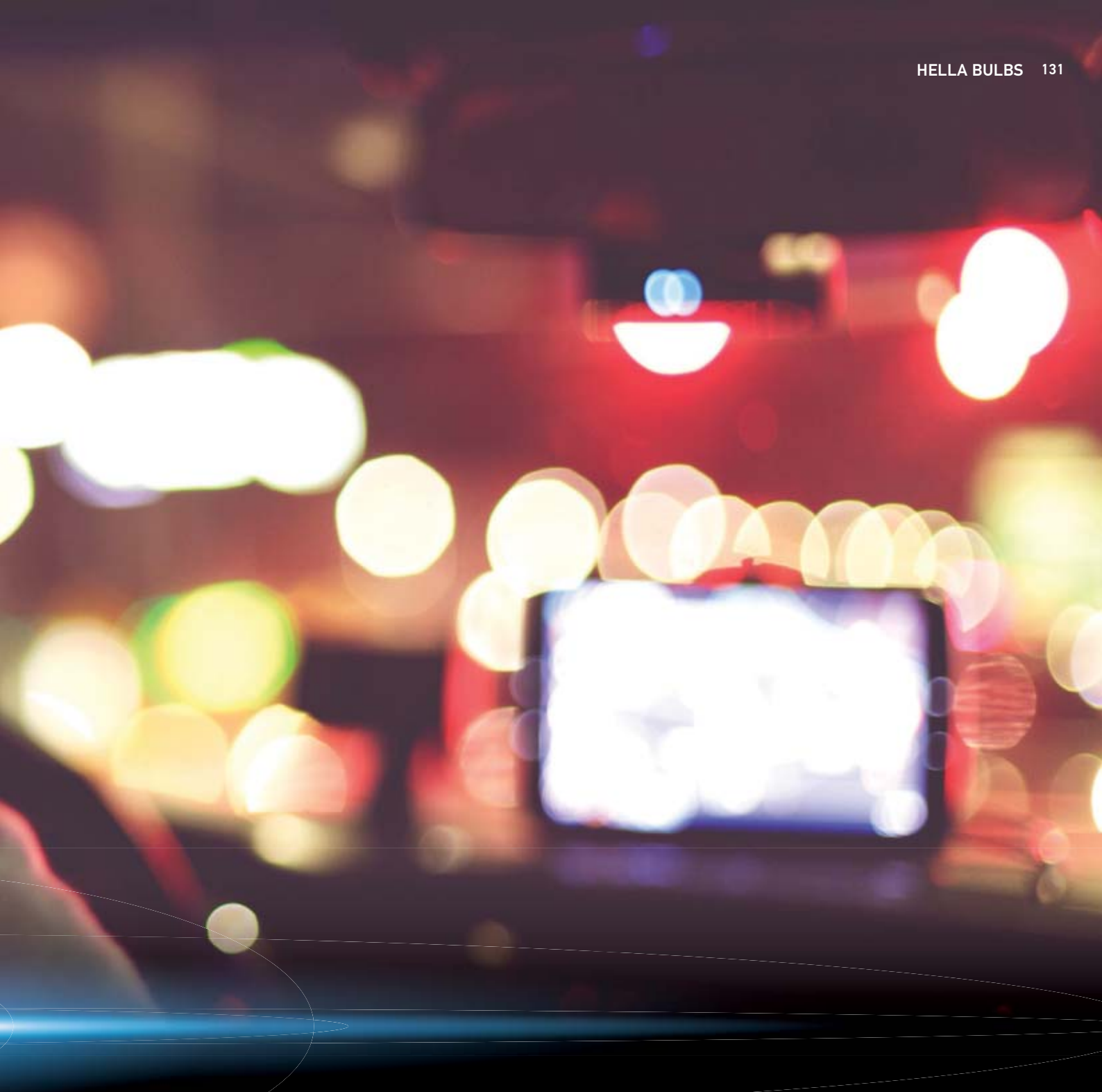

Light & age

The field of vision decreases with age.

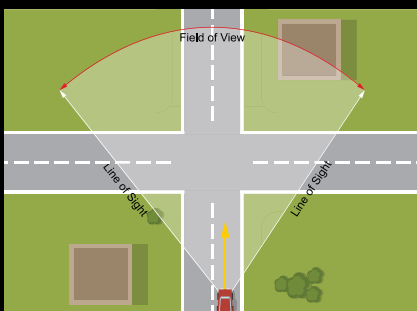

16 years

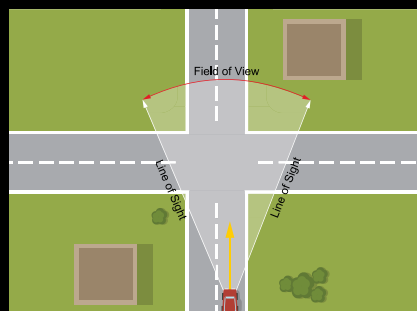

46 years

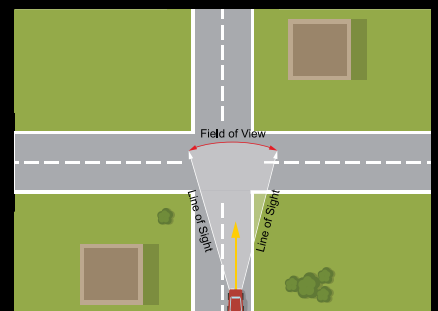

76 years

Light explained

Luminous ranges



More light means

- More light on the road where it is needed
- Better and wider illumination of the road thanks to "more light"
- Extended range (broader/further)
- Suitable light distribution: Sufficient illumination to the front and sides without dazzling other road users
- More light often means a shorter lifetime

 UP TO **50**%*

 UP TO **100**%*

* Compared to standard halogen lamps

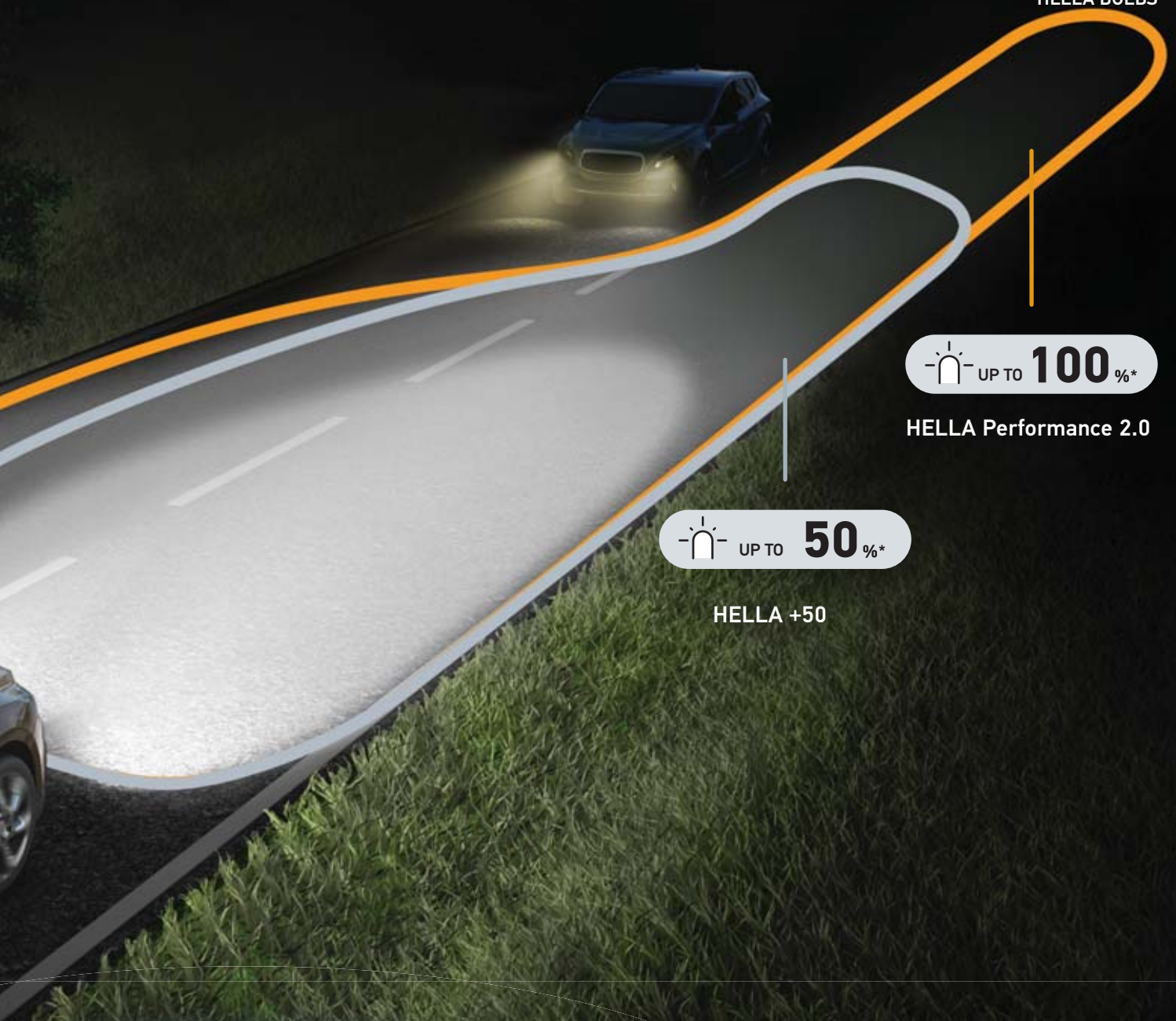

UP TO **100%***

HELLA Performance 2.0

UP TO **50%***

HELLA +50

A bulb long lifetime is

- A bulb's lifetime cannot be expressed in kilometres or years.
- Instead, it is defined by operating hours.
- Two measurements are used for bulbs: B3 and Tc.
- B3 is the minimum number of hours for 97 % of bulbs.
- After this time, the number of failed bulbs increases.
- Tc indicates the time at which 63 % of the lamps have failed.
- On average, a standard H7 lamp with 12 V has a B3 of 300 h and a Tc of 500 h according to IEC requirements. Long-life bulbs offer up to 3 times the value → the number of replacement intervals is reduced..

UP TO **2x** LIFETIME

Light explained

Light technologies

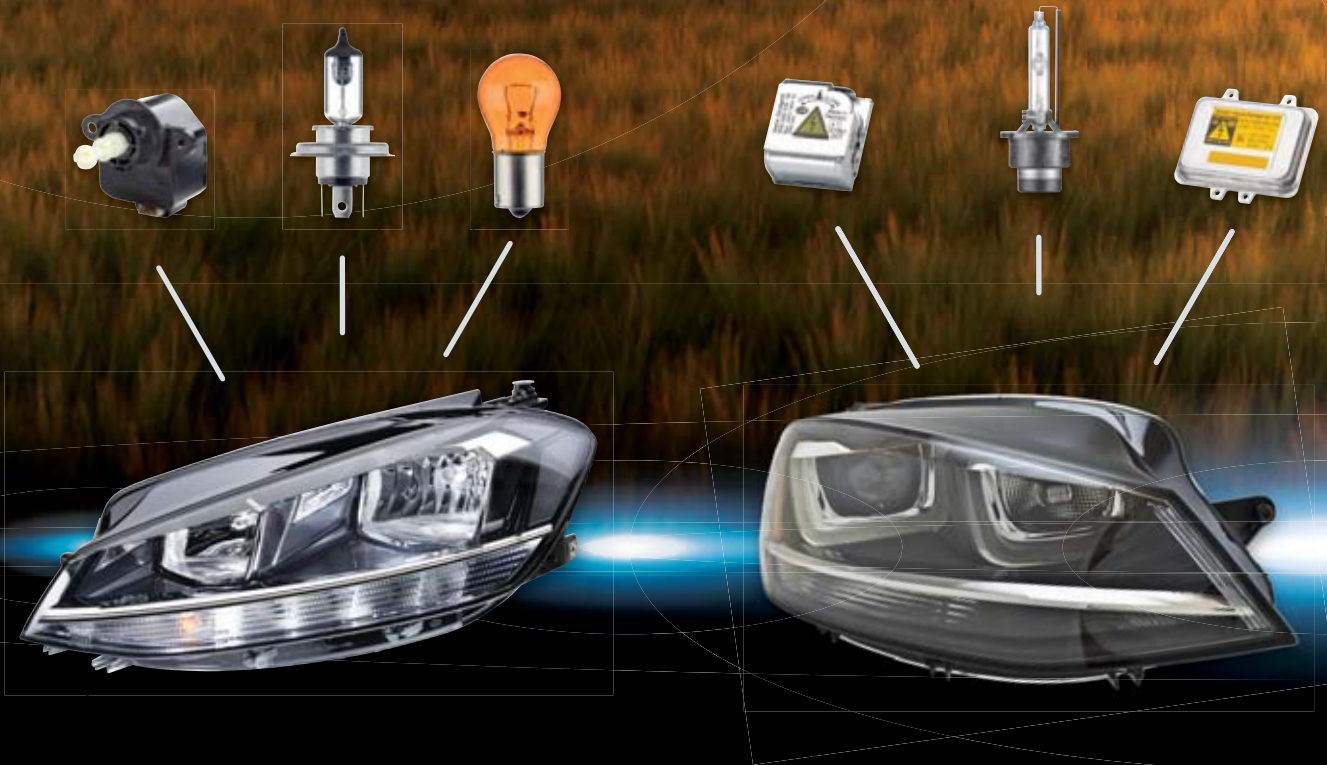

Halogen

- The classic in-vehicle lighting: a glass capsule filled with halogen gas with a tungsten wire which, when heated with electricity, emits light
- Strong price-performance ratio
- Easy replacement of the bulb

Xenon

- Better light output with up to twice as much light*
- Gas discharge lamps produce light by passing current through ionised xenon gas at high pressure
- Brighter light colour: "more light" provides brighter and wider illumination of the road*
- More complex maintenance required

* Compared to standard halogen lamps



LED

- Powerful light output and good road illumination: quick perception of surroundings and obstacles
- High energy efficiency: Contributes to the conservation of battery resources related to electromobility
- Long lifetime
- Offers attractive styling options with distinctive vehicle and light design

1

HEADLIGHT
HALOGEN STANDARD BULBS

LOW BEAM HIGH BEAM * FOG LIGHT (WHERE APPLICABLE)



2

INDICATORS

FRONT REAR SIDE



3

POSITION LIGHT

FRONT REAR



4

REVERSE LIGHT

REVERSE LIGHT



5

DASHBOARD

DASHBOARD









6

LICENSE PLATE LIGHT

LICENSE PLATE LIGHT



<p>1</p> <p>PERFORMANCE</p> <p>+50%</p> <p>H1P50TB 9004P50TB H3P50TB 9005P50TB H4P50TB 9006P50TB H7P50TB 9007P50TB H11P50TB H13P50TB</p> 	<p>PERFORMANCE</p> <p>High Performance 2.0</p> <p>H1 2.0TB 9004 2.0TB H3 2.0TB 9003 2.0TB H7 2.0TB 9005 2.0TB H9 2.0TB 9006 2.0TB H11 2.0TB 9007 2.0TB H13 2.0TB</p> 	<p>HEAVY-DUTY</p> <p>Heavy-Duty</p> <p>H3HD H11 24V DP H3 24V HD 198HD H4 24V HD 5637HD H1 24V DP 7510LTS H3 24V DP H4 24V DP H7 24V DP</p> 	<p>LED</p> <p>Fog light set</p> <p>H3 226971511 H7 226971531 H8, H11, H16 226971551</p> 
<p>LONG LIFE</p> <p>Long Life</p> <p>H1LL 9003LL H3LL 9004LL H4LL 9005LL H7LL 9006LL H11LL 9007LL H13LL 9012LL</p> 	<p>DESIGN</p> <p>OPTILUX Extreme White XB</p> <p>880 H10 881 H11 893 H13/9008 H1 H16/9009 H3 9004 / HB1 H3C 9005 / HB3 H4/9003 9005XS H7 9006 / HB4 H8 9006XS H9 9007 / HB5</p> 	<p>DESIGN</p> <p>OPTILUX Extreme Yellow XY</p> <p>880 H9 881 H10 893 H11 894 H13/9008 H1 H16/9009 H3 9004 / HB1 H3C 9005 / HB3 H4/9003 9006 / HB4 H7 9006XS H8 9007 / HB5</p> 	<p>HIGH WATTAGE</p> <p>High Wattage</p> <p>H1 100WTB H3 100WTB H3 130WTB 9004 100/80WTB 9005 100WTB 9006 80WTB 9007 100/80WTB H4 100/55WTB H4 100/80WTB H4 130/90WTB H7 100WTB H11 24V DP</p> 



11 FOG LIGHT LED 

H1	H3	H4	H7	H8/H11/H16
				
9005/9005 BH3 / HB4	9012 / HIR2	MOTORCYCLE		HS1 / H4
				





10 GLOVE BOX LIGHT 

2825 W5W	7440 C5W	5007 R5W
		

9 TRUNK LIGHT 

5007 R5W	7440 C5W	6411 10W	6411 LED
			

7 INTERIOR LIGHT 

7440 H6W	7443 R5W	5008 R10W	6413 C5W	2825 W5W	6428 M Bulb	194B LED	921 LED	6411 LED	6418 LED
									

8 STOP LIGHT 

7537 P21/5W	7225 P21/4W	7506 P21W	7440 W21W	7443 W21/5W	5007 R5W
					



PRODUCT RANGE

COMPLIES WITH ECE, SAE AND INMETRO STANDARD*

*Where applicable



STANDARD
Standard Halogen Bulbs - 12 V

862	898	H3 35W	H15
880	899	H4	H16
881	9003	H4 35/35W	HS1
884	9004	H4 45/45W	H10W
885	9005	H4 P45T	H20W
886	9005XS	H7	H21W
887	9006	H8	H5W
888	9006XS	H8B	H6W
889	9007	H9	M5 35/35W
890	9009S	H9B	M5 35/35W1
891	HIR2	H10 (9145)	M5 25/25W
892	H1	H11	M5 25/25W1
893	H2	H11B	M5 18/18W
894	H3	H12 (9055)	M5 35/35W3
896	H3C	H13	M5 25/25W3

Standard Halogen Bulbs - 24 V

H1 24V	H7 24V
H3 24V	H11 24V
H4 24V	H21W 24V

STANDARD
Standard Halogen Bulbs Blister Pack - 12 V



Double Blister Pack	Single Blister Pack
9003TB, 9004TB,	9003SB, 9004SB,
9005TB, 9006TB,	9005SB, 9006SB,
9007TB, H1TB,	9007SB, H1SB,
H10TB, H11TB,	H10SB, H11SB,
H13TB, H3TB,	H13SB, H3SB,
H3 35WTB, H4TB,	H3 35WSB, H4SB,
H4 35/35WTB,	H4 35/35WSB,
H4 45/45WTB,	H4 45/45WSB,
H4 P45TTB,	H4 P45TSB, H7SB,
H7TB, H8TB,	H8SB, H9SB,
H9TB, HS1TB	HS1SB, H16SB
M5 35/35WTB	M5 35/35WSB

Standard Halogen Bulbs Blister Pack - 24 V

Double Blister Pack	Single Blister Pack
H1 24VTB	H1 24VSB
H3 24VTB	H3 24VSB
H4 24VTB	H4 24VSB
H7 24VTB	H7 24VSB
H9 24VTB	H9 24VSB
H11 24VTB	H11 24VSB



STANDARD
Miniature Bulbs - (Box - Multiple voltages)

17	194R	3157NA	6411	7507
1003	198HD	3457	6413	7507C
1004	199	3457NA	6418	7511
1034	2057	3496	6423	7528
1034A	2057NA	3497	6424	7533
1034NA	2357	3652	6428	7534
1073	2357NA	37	6429	7537
1141	2396	3757A	6430	7951
1141 24V	2397	3796	6438	7951 55/50W
1156	24	3797	6451	7952
1156NA	24NA	3799	6453	89
1157	265	3893	6475	90
1157A	2721	3898	6476	912
1157NA	2741	3899	6480	921
1176	2722	3930	660	921NA
1176A	2723	400	67	93
1224	2741	5007	7225	9507
1308	2820	5008	7240	97
1445	2821	51	73	A3603
158	2825	53	74	A3625
158A	2825BL	57	7440	DE3021
168	2840	5627	7440A	DE3022
1683	2841	5637	7440NA	DE3175
1816	2845	5637HD	7441	DE3425
1891	2827NA	6235	7443	JC5
1893	3047	6245	7443A	JC10
1895	3047LL	6260	7443NA	JC20
194	3057	63	7506	PSX24W
194NA	3156	631	7506A	
194B	3157	635	7506NA	

STANDARD
Miniature Bulbs Blister Pack

Double Blister Pack	Single Blister Pack
7506TB	168TB
1034TB	73TB
2825TB	53TB
7528TB	1157TB
921TB	7507CTB
7443TB	1141TB
158TB	7506ATB
5007TB	6418TB
67TB	DE3021TB
3898TB	7225TB
3157TB	2827NATB
5008TB	2821TB
5637TB	7507CTB
3893TB	1141TB
7440TB	7506ATB
7507TB	6418TB
DE3175TB	DE3021TB
6411TB	7225TB
2721TB	2827NATB
	2821TB

Miniature Bulbs, Blister Pack - 24 V

Double Blister Pack	Single Blister Pack
1141 24VTB	6429TB
2741TB	7510LTSTB
2841TB	7511TB
2845TB	7534TB
3797TB	7537TB
3930TB	7952TB
5627TB	9507TB
6423TB	



STANDARD
Xenon Lamps (HID)

D1S 4300 K
D2S 4300 K
D2R 4300 K
D3S 4300 K
D4S 4300 K
D5S 4300 K



PERFORMANCE
Xenon Lamps +30 (HID)

D1S 5000 K
D2S 5000 K
D2R 5000 K



LED
LED Bulbs

5000 K	6500 K
6411LED 5K	6411LED 6.5K
6418LED 5K	6418LED 6.5K
921LED 5K	921LED 6.5K



LONG LIFE
Long Life 12 V and 24 V

9003LL	H1LL
9004LL	H4 24V LL
9005LL	H7 24V LL
9006LL	H7LL
9007LL	H11LL
9012LL	

Long Life Miniature Bulbs

1003LL	3757NALL
1141LL	4114LL
1156LL	4157NALL
1157LL	7440LL
168LL	7440NALL
194LL	7443LL
2057LL	7444NALL
2057NALL	7506ALL
2357LL	7506LL
3047LL	921LL
3057LL	DE3175LL
3157LL	



A: Amber glass



NA: Natural Amber glass

The "Amber Crystal" bulbs have an amber tint on their crystal.
The "Natural amber glass" bulbs are made with a mixture of minerals that provide the amber color in the crystal.

Part No. Nomenclature

- A: Amber glass
- NA: Natural amber glass
- BL: Blue crystal
- R: Red crystal
- C: Clear glass, (transparent)
- CB: Light blue glass
- TCB: Light blue glass - two pieces
- P50: 50% more light than standard HELLA bulbs
- HD: Heavy equipment
- YL: Yellow glass
- TB: Blister Pack double
- ◆: New product

PERFORMANCE

+50 - 12V



PERFORMANCE

High Performance 2.0



Double Plastic Case

DESIGN

Optilux Extreme White XB - 12V



Box

H1P50
H4P50
H3P50
H7P50
H11P50
H13P50
9004P50
9005P50
9006P50
9007P50

Double Blister Pack

H1P50TB
H3P50TB
H4P50TB
H7P50TB
H11P50TB
H13P50TB
9004P50TB
9005P50TB
9006P50TB
9007P50TB

Double Blister Pack

H1 2.0TB	9004 2.0TB
H3 2.0TB	9003 2.0TB
H7 2.0TB	9005 2.0TB
H9 2.0TB	9006 2.0TB
H11 2.0TB	9007 2.0TB
H13 2.0TB	

880	32 W	H71071212
881	32 W	H71071222
893	37.5 W	H71071232
9004	65/45 W	H71071392
9005	65 W	H71071402
9005	65 W	H71071412
9005	100 W	H71071422
9006	55 W	H71071432
9006	55 W	H71071442
9006	80 W	H71071452
9007	65/55 W	H71071472
H1	55 W	H71071242
H10	65 W	H71071012
H10	42 W	H71071252
H11	80 W	H71071032
H11	55 W	H71071262
H13	100/80 W	H71071052
H13	60/55 W	H71071272
H16	35 W	H71071282
H2	100 W	H71070227
H3	100 W	H71070181
H3	55 W	H71071312
H3C	55 W	H71071322
H3C	80 W	H71071332
H4	100/80 W	H71070201
H4	60/55 W	H71071352
H7	100 W	H71070307
H7	55 W	H71071362
H8	55 W	H71070772
H8	35 W	H71071372
H9	100 W	H71070792
H9	65 W	H71071382
HB1	100/80 W	H71070327
HB3	100 W	H71070347
HB4	80 W	H71070367
HB5	100/80 W	H71070387

HIGH WATTAGE

High Wattage 12 V



LED

LED Retrofit

H3 LED	226971511
H7 LED	226971531
H8, H11, H16 LED	226971551
◆ H4 LED	226971521
◆ H1 LED	226971501
◆ H11 LED	226971541
◆ 9005/9006 / HB3	226971561
◆ HIR / 9012 LED	226971571
◆ HS1 LED	226971581
◆ M5 LED	226971591
◆ 7443 LED	226971151
◆ 7443 LED	226971161
◆ 1157 LED	226971181
◆ 1156 LED	226971201



Single box

H1 100W
H1 130W
H2 100W
H3 100W
H3 130W
H3 24V 100W
H4 100/55W
H4 100/80W
H4 130/90W
H4 24V 100/90W
H7 100W
H7 70W
9004 100/80W
9005 100W
9006 80W
9007 100/80W

Double Blister Pack

H1 100WTB
H3 100WTB
H3 130WTB
H4 100/55WTB
H4 100/80WTB
H4 130/90WTB
H7 100WTB
9004 100/80WTB
9005 100WTB
9006 80WTB
9007 100/80WTB
H3 24V 100WTB
H4 24V 100/90WTB

Single Blister Pack

H4 100/80WSB
9007 100/80WSB
9004 100/80WSB
9006 80WSB
9005 100WSB

Notice that due to the high consumption it can be generated on heating in the wiring of the headlight.

STANDARD

Motorcycle Bulbs



Double Plastic Case

DESIGN

Optilux Extreme Yellow XY - 12V



DOUBLE POWER

HEAVY-DUTY

Heavy-Duty - 12 V and 24 V

Halogen

H3HD
H3 24V HD
H4 24V HD
H1 24V DP
H3 24V DP
H4 24V DP
H7 24V DP
H11 24V DP

Miniature

198HD
5637HD
7510LTS

Single Blister Pack

H1 24V DPSB
H3 24V HDSB
H3 24V DPSB
H4 24V HDSB
H4 24V DPSB
H7 24V DPSB
H11 24V DPSB

Double Blister Pack

H3 24V HDTB
H4 24V HDTB



194
635
660
2721
3652
7441
7951
7952
194NA
7440LL
7440NA
H11
H11LL
H11P50
H21W
H6W
H9

880	27 W	H71071172
881	27 W	H71071182
893	37.5 W	H71071192
9006	55 W	H71071462
H1	55 W	H71070642
H10	42 W	H71071112
H11	55 W	H71071132
H13	60/55 W	H71071152
H16	35 W	H71071302
H3	55 W	H71070662
H3C	55 W	H71071342
H4	60/55 W	H71070682
H7	55 W	H71070702
H8	35 W	H71071072
H9	65 W	H71071092
HB1	65/45 W	H71070562
HB3	65 W	H71070582
HB4	55 W	H71070602
HB5	60/55 W	H71070622

LED Retrofit

Portfolio of headlamps and fog lamps



Stylish look with daylight effect

With our LED retrofits, vehicle lighting can be converted to the latest LED technology. The new LED retrofits offer exceptional brightness and, thanks to optimised light distribution, there is more light on the road where it is needed. A longer lifetime compared to halogen bulbs makes the LED retrofits attractive for all drivers. The stylish look with a cool white beam brings customers a daylight effect at night and more comfort and

pleasure when driving. Our new portfolio offers a comprehensive range of applications, including high beam, low beam, fog lamps and a broad coverage of different vehicles.

**LED
UPGRADE**

Product Video



<https://youtu.be/Sq61XhM67g4>



Standard halogen bulb



HELLA LED Retrofit



 12 V

LED (~H1)



LED RETROFIT

226971501

Set of 2

12 / 24

19 W

P14.5s

Up to 6500 K



LED (~H3)



LED RETROFIT

226971511

Set of 2

12 / 24

19 W

PK22s

Up to 6500 K



LED (~H4)



LED RETROFIT

226971521

Set of 2

12 / 24

24 W

P43t

Up to 6500 K



LED (~H7)



LED RETROFIT

226971531

Set of 2

12 / 24

24 W

PX26d

Up to 6500 K



LED-FOG (~H8/H11/H16)



LED RETROFIT

226971551

Set of 2

12 / 24

24 W

PGJ19-1/2/3 Up to 6500 K



LED (~9005/9006~HB3/HB4)



LED RETROFIT

226971561

Set of 2

12 / 24

24 W

P20d/P22d Up to 6500 K



LED (~9012 / HIR2)



LED RETROFIT

226971571

Set of 2

12 / 24

24 W

PX22d

Up to 6500 K



12 V

LED (~HS1/H4 Moto)



LED RETROFIT	226971581	Set of 2	12	6	P43t	Up to 6500 K
---------------------	-----------	----------	----	---	------	--------------

LED (~M5 Moto)



LED RETROFIT	226971591	Set of 2	12	6	P15d-25-1	Up to 6500 K
---------------------	-----------	----------	----	---	-----------	--------------

ACCESSORIES



Description	LED CANBUS Adapter for LED-HL (~ H7)	LED CANBUS Adapter for LED-Fog (~ H8, H11, H16)	LED LIGHT REPAIR CANBUS for LED-HL (~ H7)	Adapter Rings KIT
Part Number	226971611	226971631	226971621	226971641
Packaging Unit	Set of 2	Set of 2	Set of 2	Assortment

LED retrofit small lamps

Range for outdoor
lighting functions



Bright output for outdoor applications

HELLA LED Retrofit



HELLA LED Retrofit



12V
Catalog Part Number

6418 LED - Festoon 36 mm



MINI LED	6418LED 5K	178560551	Set of 2	12	1	SV8.5-8	White Light 5,000 K Replace: 6418
	6418LED 6.5K	178560561	Set of 2	12	1	SV8.5-8	White Light 6,500 K Replace: 6418

6411 LED - Festoon 41 mm



MINI LED	6411LED 5K	178560571	Set of 2	12	1	SV8.5-8	White Light 5,000 K Replace: 6411, 6413, 6451, 6475
	6411LED 6.5K	178560581	Set of 2	12	1	SV8.5-8	White Light 6,000 K Replace: 6411, 6413, 6451, 6475

921 LED - T10 White (~W5W)



MINI LED	921LED 5K	178560591	Set of 2	12	1	W2,1x9,5d	White Light 6,000 K Replace: 921, 158, 168, 194, 2820, 2821, 2825, 2827, 3652, 912
	921LED 6.5K	178560601	Set of 2	12	1	W2,1x9,5d	White Light 6,000 K Replace: 921, 158, 168, 194, 2820, 2821, 2825, 2827, 3652, 912

3157W LED (~P27/7W)



MINI LED	3157W LED	226971151	Set of 2	12	3	W2.5x16q	White Ligh 6,000 K. Replace: 3047, 3057, 3157, 3156, 3457, 4057, 4114, 4157
----------	-----------	-----------	----------	----	---	----------	---

7443W LED (~W21/5W)



MINI LED	7443W LED	226971161	Set of 2	12	3	W3x16q	White Ligh 6,000 K. Replace: 7443
----------	-----------	-----------	----------	----	---	--------	-----------------------------------

1157W LED (~P21/5W)



MINI LED	1157W LED	226971181	Set of 2	12	3	BAY15d	White Ligh 6,000 K. Replace: 1034, 1157, 2057, 2357, 2397, 3496, 7528, P21/5W
----------	-----------	-----------	----------	----	---	--------	---

1156W LED (~P21W)



MINI LED	1156W LED	226971201	Set of 2	12	3	BA15s	White Ligh 6,000 K. Replace: 1073, 1093, 1129, 1141, 1147, 1159, 1259, 1295, 3496, 5007, 5008, 7506, 1156, P21W
----------	-----------	-----------	----------	----	---	-------	---

HELLA HALOGEN BULBS

PRODUCT RANGE



Standard



+50



Long Life

STANDARD

HELLA standard halogen bulbs provide a quality of original equipment manufacturer and great value for your money. The optimal balance between performance and service life. With SAE / ECE and INMETRO approval (when applicable).

- Halogen and Miniature **See page 112**
- Emergency Set **See page 133**
- LED Miniature bulbs **See page 106**
- Bulbs for Motorcycles **See page 148**
- Halogen 12 V Blister Pack **See page 138**
- Miniature Blister Pack **See page 139**
- Halogen 24 V Blister Pack **See page 140**

PERFORMANCE

Our bulbs are establishing new reference points for halogen lighting, making driving safer and more pleasant, providing a beam of light with greater intensity compared to HELLA Standard bulbs. The opaque silver lid offers an elegant look in the clear glass headlights

- High Performance 2.0 **See page 142**
- +50 **See page 143**

LONG LIFE

HELLA Long Life halogen bulbs have a long service life up to 2 times longer than HELLA standard bulbs and are more environmentally friendly, as they do not have to be replaced frequently. Provides an optimal value for your money and the best selection for frequent travelers.

See page 141



Clear Blue

Xtreme Yellow

High Performance 2.0

OPTILUX Extreme White XB

HEAVY-DUTY / DOUBLE POWER

Double power of 24V produces the light by means of a single filament. Heavy-Duty bulbs offer more power, more safety, without dazzling traffic.

The double power reduces costs by increasing the life of up to 100%.

- Heavy-Duty See page 145
- Double Power See page 145

HIGH WATTAGE

It offers more light, with double brightness compared to HELLA standard halogen bulbs and greater luminous efficiency, its Special filament guarantees safety and relaxed driving in off-road conditions.

Note: Take into account that due to the high wattage it can generate on heating the wiring of the headlight.

See page 144







DESIGN

Our design bulbs meet special requirements regarding design and safety. The xenon-like effect makes whiter light the correct alternative for design-oriented drivers. Our range of products:

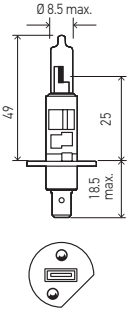
OPTILUX

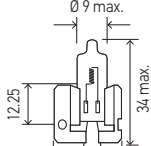
- Extreme Yellow XY See page 146
- Extreme White XB See page 147

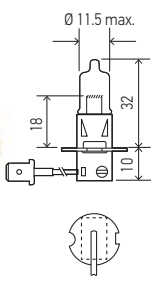

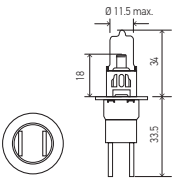
Product Image / Dimensions	Part Number	Voltage	Wattage	Base	Shape	Luminous Flux (lumens)	Kelvin	Content	Packaging	DOT	ECE	INMETRO	Features
H1  	H1	12	55 W	P14.5s	T2.5	1550		1	C	■	■	■	Standard
	H1 24V	24	70 W	P14.5s	T2.5	1900		1	C		■	■	Standard
	H1P50	12	55 W	P14.5s	T2.5	1700		1	C	■	■	■	+ 50
	H1P50TB	12	55 W	P14.5s	T2.5	1700		2	B	■	■	■	+ 50
	H1 24V DP	24	70 W	P14.5s	T2.5	1900		1	C		■	■	Double Power
	H1 100W	12	100 W	P14.5s	T2.5	1850		1	C				High Wattage
	H1 130W	12	130 W	P14.5s	T2.5	2400		1	C				High Wattage
	H1 2.0TB	12	55 W	P14.5s	T2.5	1550	3600	2	B	■	■	■	High Performance 2.0
	H1LL	12	55 W	P14.5s	T2.5	1550		1	C	■	■	■	Long Life
	H1 YL	12	55 W	P14.5s	T2.5	1550	2900	2	B				Xtreme Yellow
	H71070227*	12	100 W	P14.5s	T2.5			2	P				Extreme White XB
	H71071242*	12	55 W	P14.5s	T2.5			2	P				Extreme White XB
	H71070642*	12	55 W	P14.5s	T2.5			2	P				Extreme Yellow XY
	H1TB	12	55 W	P14.5s	T2.5	1550		2	B	■	■	■	Standard
	H1SB	12	55 W	P14.5s	T2.5	1550		1	B	■	■	■	Standard
	H1 100WTB	12	100 W	P14.5s	T2.5	1850		2	B				High Wattage
	H1 24VSB	24	70 W	P14.5s	T2.5			1	B		■	■	Standard
	H1 24VTB	24	70 W	P14.5s	T2.5			2	B		■	■	Standard
	H1 24V DPSB	24	70 W	P14.5s	T2.5			1	B		■	■	Double Power
	LOW BEAM, HIGH BEAM, FOG LIGHT (WHERE APPLICABLE)												
H2  	H2	12	55 W	X511	T3			1	C			■	Standard
	H2 100W	12	100 W	X511	T3			1	C				High Wattage
LOW BEAM, HIGH BEAM, FOG LIGHT (WHERE APPLICABLE)													
H3    <p>H3 BULLET</p>	H3	12	55 W	PK22s	T3.25	1450		1	C	■	■	■	Standard
	H3 BULLET	12	55 W	PK22s	T3.25	1450		1	C				Standard
	H3 35W	12	35 W	PK22s	T3.25	750		1	C				Standard
	H3 24V	24	70 W	PK22s	T3.25	1750		1	C		■	■	Standard
	H3P50	12	55 W	PK22s	T3.25	1600		1	C				+ 50
	H3P50TB	12	55 W	PK22s	T3.25	1600		2	B				+ 50
	H3XE-100CB	12	100 W	PK22s	T3.25	1600	3600	1	C				Clear Blue/High W
	H3 24V DP	24	70 W	PK22s	T3.25			1	C		■	■	Double Power
	H3 24V HD	24	70 W	PK22s	T3.25	1750		1	C		■	■	Heavy-Duty
	H3HD	12	55 W	PK22s	T3.25	1450		1	C	■	■	■	Heavy-Duty
	H3 100W	12	100W	PK22s	T3.25	1850		1	C				High Wattage
	H3 130W	12	130 W	PK22s	T3.25	2600		1	C				High Wattage
	H3 24V 100W	24	100 W	PK22s	T3.25	2500		1	C				High Wattage
	H3 100WTB	12	100 W	PK22s	T3.25	1850		2	B				High Wattage
	H3 130WTB	12	130 W	PK22s	T3.25	2600		2	B				High Wattage
	H3 2.0TB	12	55 W	PK22s	T3.25	1450	3600	2	B	■	■	■	High Performance 2.0
	H3 YL	12	55 W	PK22s	T3.25	1450	2900	2	B				Xtreme Yellow
	H71070181*	12	100 W	PK22s	T3.25			2	P				Extreme White XB
	H71071312*	12	55 W	PK22s	T3.25			2	P				Extreme White XB
	H71070662*	12	55 W	PK22s	T3.25			2	P				Extreme Yellow XY
H3TB	12	55 W	PK22s	T3.25	1450		2	B	■	■	■	Standard	
H3 35WTB	12	35 W	PK22s	T3.25	750		2	B				Standard	
H3SB	12	55 W	PK22s	T3.25	1450		1	B	■	■	■	Standard	
H3 35WSB	12	35 W	PK22s	T3.25	750		1	B				Standard	
H3 24V DPSB	24	70 W	PK22s	T3.25			1	B		■	■	Double Power	
H3 24V HDSB	24	70 W	PK22s	T3.25			1	B		■	■	Heavy-Duty	
H3 24VSB	24	70 W	PK22s	T3.25			1	B		■	■	Standard	
H3 24V 100WTB	24	100 W	PK22s	T3.25			2	B				High Wattage	
H3 24V HDTB	24	70 W	PK22s	T3.25			2	B		■	■	Heavy-Duty	
H3 24VTB	24	70 W	PK22s	T3.25			2	B		■	■	Standard	
H3C  	H71071322*	12	55 W	P22d	T3.25			2	P				Extreme White XB
	H71071332*	12	80 W	P22d	T3.25			2	P				Extreme White XB
	H71071342*	12	55 W	P22d	T3.25			2	P				Extreme Yellow XY
LOW BEAM, HIGH BEAM, FOG LIGHT (WHERE APPLICABLE)													

C = Box B = Blister Pack P = Plastic Case
 * = OPTILUX Product Range ◆ = New Product

Measures in millimeters







Product Image / Dimensions	Part Number	Voltage	Wattage	Base	Shape	Luminous Flux (lumens)	Kelvin	Content	Packaging	DOT	ECE	INMETRO	Features
H4 	H4	12	60/55 W	P43t	T4.625	1650/1000	3200	1	C		■	■	Standard
	H4 24V	24	75/70 W	P43t	T4.625	1900/1200		1	C		■	■	Standard
	H4 35/35W	12	35/35 W	P43t	T4.625	825/525		1	C				Standard
	H4 45/45W	12	45/45 W	P43t	T4.625			1	C				Standard
	H4 P45T	12	60/55 W	P45t	T4.625	1650/1000		1	C				Standard
	H4P50	12	60/55 W	P43t	T4.625	1815/1100		1	C		■	■	+ 50
	H4P50TB	12	60/55 W	P43t	T4.625	1815/1100		2	B		■	■	+ 50
	H4XE-CB	12	60/55 W	P43t	T4.625	1650/1000	3600	1	C				Clear Blue
	H4XE-100CB	12	100/80 W	P43t	T4.625	2000/1350	3600	1	C				Clear Blue/High W
	H4 24V DP	24	75/70 W	P43t	T4.625	1900/1200		1	C		■	■	Double Power
	H4 24V HD	24	75/70 W	P43t	T4.625	1900/1200		1	C		■	■	Heavy-Duty
	H4 100/55W	12	100/55 W	P43t	T4.625	2400/1000		1	C				High Wattage
	H4 100/80W	12	100/80 W	P43t	T4.625			1	C				High Wattage
	H4 130/90W	12	130/90 W	P43t	T4.625	3200/1600		1	C				High Wattage
	H4 24V 100/90W	24	100/90 W	P43t	T4.625			1	C				High Wattage
	H4 100/55WTB	12	100/55 W	P43t	T4.625	2400/1000		2	B				High Wattage
	H4 100/80WTB	12	100/80 W	P43t	T4.625			2	B				High Wattage
	H4 130/90WTB	12	130/90 W	P43t	T4.625	3200/1600		2	B				High Wattage
	H4 100/80WSB	12	100/80 W	P43t	T4.625			1	B				High Wattage
	H4 24V LL	24	75/70 W	P43t	T4.625	1900/1200		1	C				Long Life
	H4 YL	12	60/55 W	P43t	T4.625	1650/1000	2800	2	P				Xtreme Yellow
	H71070201*	12	100/80 W	P43t	T4.625			2	P				Extreme White XB
	H71071352*	12	60/55 W	P43t	T4.625			2	P				Extreme White XB
	H71070682*	12	60/55 W	P43t	T4.625			2	P				Extreme Yellow XY
	H4TB	12	60/55 W	P43t	T4.625	1650/1000	3200	2	B		■	■	Standard
	H4 35/35WTB	12	35/35 W	P43t	T4.625			2	B				Standard
	H4 45/45WTB	12	45/45 W	P43t	T4.625			2	B				Standard
	H4 P45TTB	12	60/55 W	P45t	T4.625			2	B				Standard
	H4SB	12	60/55 W	P43t	T4.625	1650/1000	3200	1	B		■	■	Standard
	H4 35/35WSB	12	35/35 W	P43t	T4.625			1	B				Standard
	H4 45/45WSB	12	45/45 W	P43t	T4.625			1	B				Standard
	H4 P45TSB	12	60/55 W	P45t	T4.625	1650/1000		1	B				Standard
	H4 24V 100/90WTB	24	100/90 W	P43t	T4.625			2	B				High Wattage
	H4 24V HDTB	24	75/70 W	P43t	T4.625			2	B		■	■	Heavy-Duty
	H4 24VTB	24	75/70 W	P43t	T4.625			2	B		■	■	Standard
H4 24V DPSB	24	75/70 W	P43t	T4.625			1	B		■	■	Double Power	
H4 24V HDSB	24	75/70 W	P43t	T4.625			1	B		■	■	Heavy-Duty	
H4 24VSB	24	75/70 W	P43t	T4.625			1	B		■	■	Standard	

LOW BEAM, HIGH BEAM, FOG LIGHT (WHERE APPLICABLE)

H7 	H7	12	55 W	PX26d	T4.625	1350		1	C	■	■	■	Standard
	H7 24V	24	70 W	PX26d	T4.625	1750		1	C		■	■	Standard
	H7P50	12	55 W	PX26d	T4.625	1560		1	C		■	■	+ 50
	H7P50TB	12	55 W	PX26d	T4.625	1560		2	B		■	■	+ 50
	H7 24V DP	24	70 W	PX26d	T4.625			1	C		■	■	Double Power
	H7 70W	12	70 W	PX26d	T4.625	1800		1	C				High Wattage
	H7 100W	12	100 W	PX26d	T4.625	2000		1	C				High Wattage
	H7 100WTB	12	100 W	PX26d	T4.625	2000		2	B				High Wattage
	H7 2.0TB	12	55 W	PX26d	T4.625	1500		2	P		■	■	High Performance 2.0
	H7 24V LL	24	70 W	PX26d	T4.625	1750		1	C		■	■	Long Life
	H7LL	12	55 W	PX26d	T4.625	1500	3700	1	C		■	■	Long Life
	H7 YL	12	55 W	PX26d	T4.625	1500		2	P				Xtreme Yellow
	H71070307*	12	100 W	PX26d	T4.625			2	P				Extreme White XB
	H71071362*	12	55 W	PX26d	T4.625			2	P				Extreme White XB
	H71070702*	12	55 W	PX26d	T4.625			2	P				Extreme Yellow XY
	H7TB	12	55 W	PX26d	T4.625	1350		2	B		■	■	Standard
	H7SB	12	55 W	PX26d	T4.625	1350		1	B		■	■	Standard
H7 24VSB	24	70 W	PX26d	T4.625			1	B		■	■	Standard	
H7 24VTB	24	70 W	PX26d	T4.625			2	B		■	■	Standard	
H7 24V DPSB	24	70 W	PX26d	T4.625			1	B		■	■	Double Power	

LOW BEAM, HIGH BEAM, FOG LIGHT (WHERE APPLICABLE)



Product Image / Dimensions	Part Number	Voltage	Wattage	Base	Shape	Luminous Flux (lumens)	Kelvin	Content	Packaging	DOT	ECE	INMETRO	Features	
H8  	H8	12	35 W	PGJ19-1	T4	800		1	C	■	■		Standard	
	H71070772*	12	55 W	PGJ19-1	T4			2	P				Extreme White XB	
	H71071072*	12	35 W	PGJ19-1	T4			2	P				Extreme Yellow XY	
	H71071372*	12	35 W	PGJ19-1	T4			2	P				Extreme White XB	
	H8TB	12	35 W	PGJ19-1	T4	800		2	B	■	■		Standard	
	H8SB	12	35 W	PGJ19-1	T4	800		1	B	■	■		Standard	
	H8B	12	35 W	PGJ19-1	T4	800		1	C		■		Standard	
	LOW BEAM, HIGH BEAM, FOG LIGHT (WHERE APPLICABLE)													
	H9  	H9	12	65 W	PGJ19-5	T4	2100		1	C	■	■		Standard
		H9 2.0TB	12	65 W	PGJ19-5	T4	2100	3700	2	P	■	■		High Performance 2.0
H71070792*		12	100 W	PGJ19-5	T4			2	P				Extreme White XB	
H71071092*		12	65 W	PGJ19-5	T4			2	P				Extreme Yellow XY	
H71071382*		12	65 W	PGJ19-5	T4			2	P				Extreme White XB	
H9TB		12	65 W	PGJ19-5	T4	2100		2	B	■	■		Standard	
H9SB		12	65 W	PGJ19-5	T4	2100		1	B				Standard	
H9 24VSB		24	80 W	PGJ19-5	T4			1	B				Standard	
H9 24VTB		24	80 W	PGJ19-5	T4			2	B				Standard	
H9B		12	65 W	PGJ19-5	T4	2100		1	C		■		Standard	
HIGH BEAM, WORK LIGHT														
H10 	H10	12	45 W	PY20d	T4	850		1	C		■		Standard	
	H71071012*	12	65 W	PY20d	T4			2	P				Extreme White XB	
	H71071112*	12	42 W	PY20d	T4			2	P				Extreme Yellow XY	
	H71071252*	12	42 W	PY20d	T4			2	P				Extreme White XB	
	H10TB	12	45 W	PY20d	T4	850		2	B		■		Standard	
	H10SB	12	45 W	PY20d	T4	850		1	B		■		Standard	
	LOW BEAM													
H11 	H11	12	55 W	PGJ19-2	T4	1350		1	C	■	■		Standard	
	H11 24V	24	70 W	PGJ19-2	T4	1600		1	C		■		Standard	
	H11P50	12	55 W	PGJ19-2	T4	1450		1	C	■	■		+ 50	
	H11P50TB	12	55 W	PGJ19-2	T4	1450		2	B				+ 50	
	H11XE-CB	12	55 W	PGJ19-2	T4	1350	3600	1	C				Clear Blue	
	H11 24V DP	24	70 W	PGJ19-2	T4			1	C		■		Double Power	
	H11 2.0TB	12	55 W	PGJ19-2	T4	1350	3700	2	P	■	■		High Performance 2.0	
	H11LL	12	55 W	PGJ19-2	T4	1350		1	C	■	■		Long Life	
	H11 YL	12	55 W	PGJ19-2	T4	1450	3000	2	B				Xtreme Yellow	
	H71071032*	12	80 W	PGJ19-2	T4			2	P				Extreme White XB	
	H71071132*	12	55 W	PGJ19-2	T4			2	P				Extreme Yellow XY	
	H71071262*	12	55 W	PGJ19-2	T4			2	P				Extreme White XB	
	H11TB	12	55 W	PGJ19-2	T4	1350		2	B	■	■		Standard	
	H11SB	12	55 W	PGJ19-2	T4	1350		1	B	■	■		Standard	
	H11 24V DPSB	24	70 W	PGJ19-2	T4			1	B		■		Double Power	
	H11 24VSB	24	70 W	PGJ19-2	T4			1	B		■		Standard	
H11 24VTB	24	70 W	PGJ19-2	T4			2	B		■		Standard		
LOW BEAM														

C = Box B = Blister Pack P = Plastic Case
 * = OPTILUX Product Range ◆ = New Product

Measures in millimeters

Product Image / Dimensions	Part Number	Voltage	Wattage	Base	Shape	Luminous Flux (lumens)	Kelvin	Content	Packaging	DOT	ECE	INMETRO	Features
H11B 	H11B	12	55 W	PGJY192	T3.25	1345	3100	1	C	■	■		Standard
	LOW BEAM, HIGH BEAM, FOG LIGHT (WHERE APPLICABLE)												
H12 	H12	12	55 W	PZ20d	T4	1050		1	C		■		Standard
	LOW BEAM, HIGH BEAM, FOG LIGHT (WHERE APPLICABLE)												
H13 9008 	H13	12	60/55 W	P26.4t	T4	1700/1100		1	C	■	■		Standard
	H13P50	12	60/55 W	P26.4t	T4	1650/1100		1	C	■	■		+ 50
	H13P50TB	12	60/55 W	P26.4t	T4	1650/1100		2	B	■	■		+ 50
	H13 2.0TB	12	60/55 W	P26.4t	T4	1700/1100	3700	2	P	■	■		High Performance 2.0
	H13 YL	12	60/55 W	P26.4t	T4	1700/1100	3100	2	B				Xtreme Yellow
	H71071052*	12	100/80 W	P26.4t	T4			2	P				Extreme White XB
	H71071272*	12	60/55 W	P26.4t	T4			2	P				Extreme White XB
	H71071152*	12	60/55 W	P26.4t	T4			2	P				Extreme Yellow XY
	H13TB	12	60/55 W	P26.4t	T4	1700/1100		2	B	■	■		Standard
	H13SB*	12	60/55 W	P26.4t	T4	1700/1100		1	B	■	■		Standard
	LOW BEAM, HIGH BEAM, FOG LIGHT (WHERE APPLICABLE)												
H15 	H15	12	15/55 W	PGJ23t-1	T4	1330	3100	1	C	■	■		Standard
	FOG LIGHT												
H16 	H16	12	19 W	PGJ19-3	T4		3700	1	C		■		Standard
	H16SB	12	19 W	PGJ19-3	T4		3700	1	B				Standard
FOG LIGHT													
HS1 	HS1	12	35/35 W	PX43t	T4.625			1	C		■		Standard
	HS1TB	12	35/35 W	PX43t	T4.625			2	B		■		Standard
	HS1SB	12	35/35 W	PX43t	T4.625			1	B		■		Standard
LOW BEAM, HIGH BEAM, FOG LIGHT (WHERE APPLICABLE)													



Product Image / Dimensions	Part Number	Voltage	Wattage	Base	Shape	Luminous Flux (lumens)	Kelvin	Content	Packaging	DOT	ECE	INMETRO	Features
----------------------------	-------------	---------	---------	------	-------	------------------------	--------	---------	-----------	-----	-----	---------	----------

**H20W
H5W**

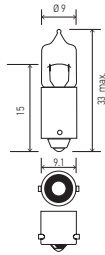

H20W	12	20 W	BA9s	T2.75	470			1	C				Standard
H5W	12	5 W	BA9s	T2.75	80			1	C				Standard

FLASHER LIGHT, REAR TURN SIGNAL, FRONT, SIDE AND TAIL LIGHT

H6W

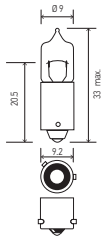

H6W	12	6 W	BAX9s	T2.75	125			1	C		■		Standard
------------	----	-----	-------	-------	-----	--	--	---	---	--	---	--	----------

PARKING LIGHT

H10W

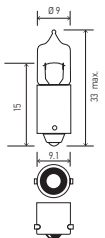

H10W	12	10 W	BA9s	T2.75				1	C			■	Standard
-------------	----	------	------	-------	--	--	--	---	---	--	--	---	----------

PARKING LIGHT

H21W

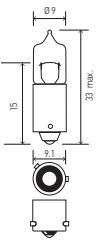

H21W	12	21 W	BAY9s	T2.75	600			1	C		■	■	Standard
H21W 24V	24	21 W	BAY9s	T2.75				1	C		■	■	Standard

FLASHER LIGHT, REAR TURN SIGNAL, FRONT, SIDE AND TAIL LIGHT

880

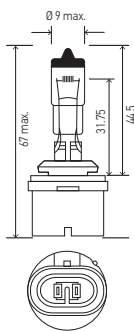

880	12	27 W	PG13	T3.25	540			1	C		■	■	Standard
H71071172*	12	27 W	PG13	T3.25				2	P				Extreme Yellow XY
H71071212*	12	32 W	PG13	T3.25				2	P				Extreme White XB
880 YL	12	27 W	PG13	T3.25				2	B				Xtreme Yellow

Many bulbs of the 800 series are physically interchangeable but not electrically. Serious damage and blinding by glare can result from misuse of the bulb, so it is important to use only the bulb that is specified for each application.

LOW BEAM, HIGH BEAM, FOG LIGHT (WHERE APPLICABLE)

881,896, 898

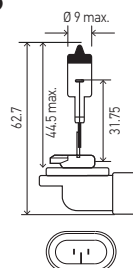

881	12	27 W	PGJ13	T3.25	540			1	C		■	■	Standard
896	12	37.5 W	PGJ13	T3.25	940	3100		1	C				Standard
898	12	37.5 W	PGJ13	T3.25	750	3100		1	C				Standard
H71071182*	12	27 W	PGJ13	T3.25				2	P				Extreme Yellow XY
H71071222*	12	32 W	PGJ13	T3.25				2	P				Extreme White XB

Many bulbs of the 800 series are physically interchangeable but not electrically. Serious damage and blinding by glare can result from misuse of the bulb, so it is important to use only the bulb that is specified for each application.

LOW BEAM, FOG LIGHT (WHERE APPLICABLE)

Product Image / Dimensions	Part Number	Voltage	Wattage	Base	Shape	Luminous Flux (lumens)	Kelvin	Content	Packaging	DOT	ECE	INMETRO	Features
----------------------------	-------------	---------	---------	------	-------	------------------------	--------	---------	-----------	-----	-----	---------	----------

884, 885, 887, 890, 892

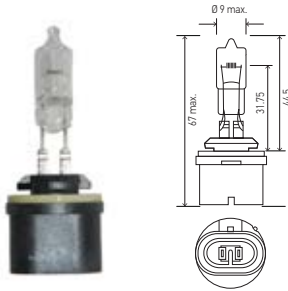

884	12	27 W	PG13	T3.25	540			1	C				Standard
885	12	50 W	PG13	T3.25	1250			1	C				Standard
887	12	50 W	PG13	T3.25	1190			1	C				Standard
890	12	27 W	PG13	T3.25	540	1100		1	C				Standard
892	12	16 W	PG13	T3.25	350			1	C				Standard

Many bulbs of the 800 series are physically interchangeable but not electrically. Serious damage and blinding by glare can result from misuse of the bulb, so it is important to use only the bulb that is specified for each application.

LOW BEAM, FOG LIGHT (WHERE APPLICABLE)

891

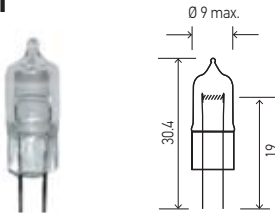

891	12	8 W	G4	T3.25	135	3100		1	C				Standard
------------	----	-----	----	-------	-----	------	--	---	---	--	--	--	----------

LOW BEAM, FOG LIGHT (WHERE APPLICABLE)

893

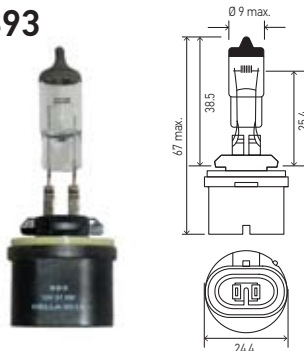

893	12	37.5 W	PG13	T3.25	940			1	C				Standard
H71071192*	12	37.5 W	PG13	T3.25				2	P				Extreme Yellow XY
H71071232*	12	37.5 W	PG13	T3.25				2	P				Extreme White XB

Many bulbs of the 800 series are physically interchangeable but not electrically. Serious damage and blinding by glare can result from misuse of the bulb, so it is important to use only the bulb that is specified for each application.

LOW BEAM, FOG LIGHT (WHERE APPLICABLE)

862, 886, 888, 889, 894

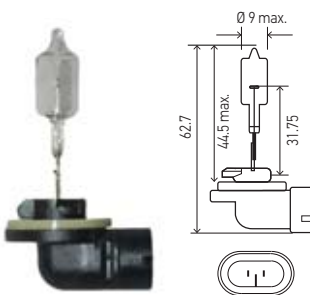

862	12	37.5 W	PGJ13	T3.25	750			1	C				Standard
886	12	50 W	PGJ13	T3.25	1190			1	C				Standard
888	12	50 W	PGJ13	T3.25	540			1	C				Standard
889	12	27 W	PGJ13	T3.25	540			1	C				Standard
889 YL	12	35 W	PGJ13	T3.25				2	B				Xtreme Yellow
894	12	37.5 W	PGJ13	T3.25	940			1	C				Standard

Many bulbs of the 800 series are physically interchangeable but not electrically. Serious damage and blinding by glare can result from misuse of the bulb, so it is important to use only the bulb that is specified for each application.

LOW BEAM, HIGH BEAM, FOG LIGHT (WHERE APPLICABLE)

9003

HB2

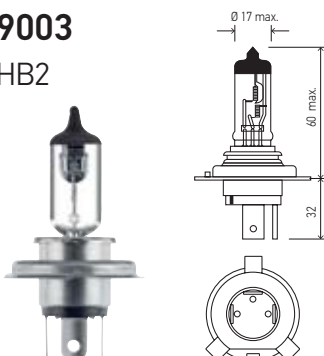

9003	12	60/55 W	P43t	T4.625	1500/910			1	C	■			Standard
9003LL	12	60/55 W	P43t	T4.625	1500/910			1	C	■			Long Life
9003 2.0TB	12	60/55 W	P43t	T4.625	1500/910	3600		2	P	■	■	■	High Performance 2.0
9003TB	12	60/55 W	P43t	T4.625	1500/910			2	B	■			Standard
9003SB	12	60/55 W	P43t	T4.625	1500/910			1	B	■			Standard

LOW BEAM, HIGH BEAM, FOG LIGHT (WHERE APPLICABLE)

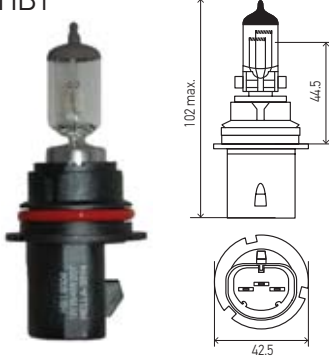

Product Image / Dimensions	Part Number	Voltage	Wattage	Base	Shape	Luminous Flux (lumens)	Kelvin	Content	Packaging	DOT	ECE	INMETRO	Features	
9004 HB1 	9004	12	65/45 W	P29t	T4.625	1200/700		1	C	■		■	Standard	
	9004P50	12	65/45 W	P29t	T4.625	1250/765		1	C	■		■	+ 50	
	9004P50TB	12	65/45 W	P29t	T4.625	1250/765		2	B	■		■	+50	
	9004XE-CB	12	65/45 W	P29t	T4.625	1100/700	3600	1	C				Clear Blue	
	9004XE-100CB	12	100/80 W	P29t	T4.625	1250/1100	3600	1	C				Clear Blue/High W	
	9004 100/80W	12	100/80 W	P29t	T4.625	1600/1300		1	C				High Wattage	
	9004 100/80WSB	12	100/80 W	P29t	T4.625	1600/1300		2	B				High Wattage	
	9004 2.0TB	12	65/45 W	P29t	T4.625	1200/700	3700	2	P	■		■	High Performance 2.0	
	9004LL	12	65/45 W	P29t	T4.625	1200/700		1	C				■	Long Life
	9004 YL	12	65/45 W	P29t	T4.625	1200/700	2800	2	B					Xtreme Yellow
	H71071392*	12	65/45 W	P29t	T4.625			2	P	■				Extreme White XB
	H71070327*	12	100/80 W	P29t	T4.625			2	P					Extreme White XB
	H71070562*	12	65/45 W	P29t	T4.625			2	P					Extreme Yellow XY
	9004TB	12	65/45 W	P29t	T4.625	1200/700		2	B	■		■		Standard
	9004SB	12	65/45 W	P29t	T4.625	1200/700		2	B	■		■		Standard

LOW BEAM, HIGH BEAM, FOG LIGHT (WHERE APPLICABLE)

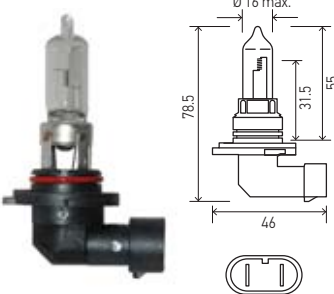
9005 HB3 	9005	12	65 W	P20d	T4	1860		1	C	■	■	■	Standard	
	9005P50	12	65 W	P20d	T4	2000		1	C	■	■	■	+ 50	
	9005P50TB	12	65 W	P20d	T4	2000		2	B	■	■	■	+ 50	
	9005XE-100CB	12	100 W	P20d	T4	1530	3600	1	C				Clear Blue/High W	
	9005 100W	12	100 W	P20d	T4	2200		1	C				High Wattage	
	9005 100WSB	12	100 W	P20d	T4	2200		2	B				High Wattage	
	9005 2.0TB	12	65 W	P20d	T4	1860	3700	2	P	■	■	■	High Performance 2.0	
	9005LL	12	65 W	P20d	T4	1860		1	C	■	■	■	Long Life	
	9005 YL	12	65 W	P20d	T4	1860	2900	2	B				Xtreme Yellow	
	H71071402*	12	65 W	P20d	T4			2	P					Extreme White XB
	H71070347*	12	100 W	P20d	T4			2	P					Extreme White XB
	H71070582*	12	65 W	P20d	T4			2	P					Extreme Yellow XY
	9005TB	12	65 W	P20d	T4	1860		2	B	■	■	■		Standard
	9005SB	12	65 W	P20d	T4	1860		1	B	■	■	■		Standard

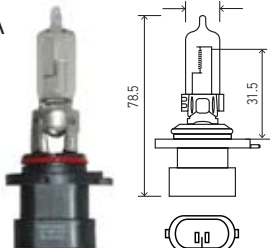

LOW BEAM, HIGH BEAM, FOG LIGHT (WHERE APPLICABLE)

9005XS HB3A 	9005XS	12	65 W	P20d	T4	1860		1	C	■	■	■	Standard	
	H71071412*	12	65 W	P20d	T4			2	P					Extreme White XB
	H71071422*	12	100 W	P20d	T4			2	P					Extreme White XB

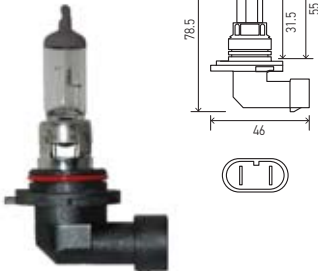





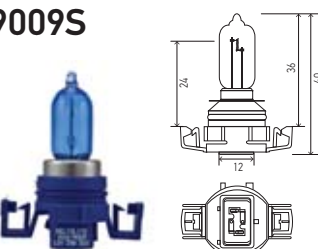
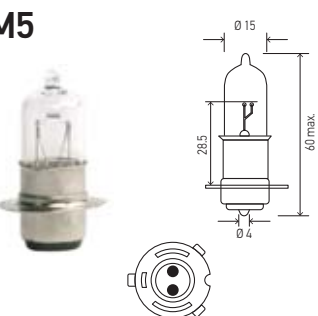

LOW BEAM, HIGH BEAM, FOG LIGHT (WHERE APPLICABLE)

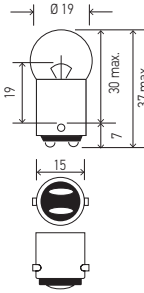
9006 HB4 	9006	12	55 W	P22d	T4	1095		1	C	■	■	■	Standard	
	9006P50	12	55 W	P22d	T4	1200		1	C	■	■	■	+ 50	
	9006P50TB	12	55 W	P22d	T4	1200		2	B	■	■	■	+ 50	
	9006XE-80CB	12	80 W	P22d	T4	1300	3600	1	C				Clear Blue/High W	
	9006 80W	12	80 W	P22d	T4	1650		1	C				High Wattage	
	9006 80WSB	12	80 W	P22d	T4	1650		2	B				High Wattage	
	9006 2.0TB	12	55 W	P22d	T4	1095	3700	2	P	■	■	■	High Performance 2.0	
	9006LL	12	55 W	P22d	T4	1095		1	C	■	■	■	Long Life	
	9006 YL	12	55 W	P22d	T4	1095	2900	2	B				Xtreme Yellow	
	H71071432*	12	55 W	P22d	T4			2	P					Extreme White XB
	H71070367*	12	80 W	P22d	T4			2	P					Extreme White XB
	H71070602*	12	55 W	P22d	T4			2	P					Extreme Yellow XY
	9006TB	12	55 W	P22d	T4	1095		2	B	■	■	■		Standard
	9006SB	12	55 W	P22d	T4	1095		1	B	■	■	■		Standard

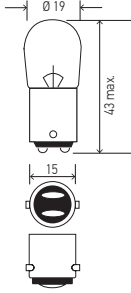
LOW BEAM, HIGH BEAM, FOG LIGHT (WHERE APPLICABLE)

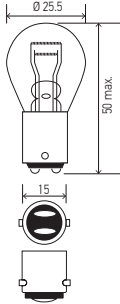
Product Image / Dimensions	Part Number	Voltage	Wattage	Base	Shape	Luminous Flux (lumens)	Kelvin	Content	Packaging	DOT	ECE	INMETRO	Features
9006XS HB4A 	9006XS	12	55 W	P22d	T4	1095		1	C	■	■	■	Standard
	H71071442*	12	55 W	P22d	T4			2	P				Extreme White XB
	H71071452*	12	80 W	P22d	T4			2	P				Extreme White XB
	H71071462*	12	55 W	P22d	T4			2	P				Extreme Yellow XY
	LOW BEAM, HIGH BEAM, FOG LIGHT (WHERE APPLICABLE)												
9007 HB5 	9007	12	65/55 W	PX29t	T4.625	1350/1000		1	C	■			Standard
	9007P50	12	65/55 W	PX29t	T4.625	1450/1100		1	C	■			+ 50
	9007P50TB	12	65/55 W	PX29t	T4.625	1450/1100		2	B	■			+ 50
	9007XE-CB	12	65/55 W	PX29t	T4.625	1350/1000	3700	1	C				Clear Blue
	9007 100/80W	12	100/80 W	PX29t	T4.625	1800/1500		1	C				High Wattage
	9007 100/80WSB	12	100/80 W	PX29t	T4.625	1800/1500		2	B	■			High Wattage
	9007 2.0TB	12	65/55 W	PX29t	T4.625	1350/1000	3700	2	P	■			High Performance 2.0
	9007LL	12	65/55 W	PX29t	T4.625	1350/1000		1	C				Long Life
	9007 YL	12	65/55 W	PX29t	T4.625	1350/1000	2800	2	B				Xtreme Yellow
	H71071472*	12	65/55 W	PX29t	T4.625			2	P				Extreme White XB
	H71070387*	12	100/80 W	PX29t	T4.625			2	P				Extreme White XB
	H71070622*	12	60/55 W	PX29t	T4.625			2	P				Extreme Yellow XY
	9007TB	12	60/55 W	PX29t	T4.625	1350/1000		2	B				Standard
9007SB	12	60/55 W	PX29t	T4.625	1350/1000		1	B				Standard	
LOW BEAM, HIGH BEAM, FOG LIGHT (WHERE APPLICABLE)													
9012 HIR2 	9012LL	12	55 W	PX22d	T4			1	C	■	■		Long Life
	LOW BEAM, HIGH BEAM												
9009S 	H71071282*	12	35 W	PG20-3	T4			2	P				Extreme White XB
	H71071302*	12	35 W	PG20-3	T4			2	P				Extreme Yellow XY
	LOW BEAM, HIGH BEAM, FOG LIGHT (WHERE APPLICABLE)												
M5 	◆ M5 35/35W	12	35/35 W	P15d-25-1		840/805		1	C				Standard
	◆ M5 35/35WTB	12	35/35 W	P15d-25-1		840/805		2	B				Standard
	◆ M5 35/35WSB	12	35/35 W	P15d-25-1		840/805		1	B				Standard
	◆ M5 35/35W1	12	35/35 W	BA20D		840/805		1	C	■			Standard
	◆ M5 25/25W	12	25/25 W	BA20D		540/540		1	C	■			Standard
	◆ M5 25/25W1	12	25/25 W	P15D-25-1		540/540		1	C	■			Standard
	◆ M5 18/18W	12	18/18 W	P15D-25-1		440/440		1	C	■			Standard
	◆ M5 35/35W3	12	35/35 W	P15D-25-3		840/805		1	C	■			Standard
	◆ M5 25/25W3	12	25/25 W	P15D-25-3		540/540		1	C	■			Standard
	LOW BEAM, HIGH BEAM, FOG LIGHT (WHERE APPLICABLE)												

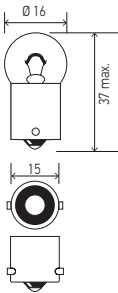

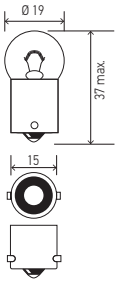
Product Image / Dimensions	Part Number	Voltage	Wattage	Base	Shape	Luminous Flux (lumens)	Kelvin	Content	Packaging	DOT	ECE	INMETRO	Features
 	90	12	8 W	BA15d	G6	125		10	C	■			Standard
	1224	32	5 W	BA15d	G6	125		10	C	■			Standard
STOP LIGHT, REAR POSITION LIGHT													
 	1004	12	12.8 W	BA15d	B6			10	C	■			Standard
	PARKING LIGHT, LICENSE PLATE LIGHT, GLOVE COMPARTMENT LIGHT, TRUNK LIGHT												
 	1176	12	17/8 W	BA15d	S8			10	C	■			Standard
	1176A	12	16/8 W	BA15d	S8			10	C	■			Standard (Amber)
	7240	12	21/5 W	BA15d	S8			10	C				Standard
	7533	12	15 W	BA15d	S8			10	C				Standard
	7534	24	21/5 W	BA15d	S8			10	C				Standard
	7534TB	24	21/5 W	BA15d	S8			2	B				Standard
STOP LIGHT, REAR POSITION LIGHT													
 	63	6	4 W	BA15s	G6			10	C	■			Standard
	631	12	9 W	BA15s	G6			10	C	■			Standard
	67	12	8 W	BA15s	G6			10	C	■			Standard
	89	12	8 W	BA15s	G6			10	C	■			Standard
	97	12	9 W	BA15s	G6			10	C	■			Standard
PARKING LIGHT, LICENSE PLATE LIGHT													
 	5007	12	5 W	BA15s	B6			10	C	■	■		Standard
	5007TB	12	5 W	BA15s	B6			2	B		■	■	Standard
	5007SB	12	5 W	BA15s	B6			1	B		■	■	Standard
	5008	12	10 W	BA15s	B6			10	C		■	■	Standard
	5008TB	12	10 W	BA15s	B6			2	B		■	■	Standard
	5008SB	12	10 W	BA15s	B6			1	B		■	■	Standard
	5627	24	5 W	BA15s	B6			10	C		■	■	Standard
	5627SB	24	5 W	BA15s	B6			1	B		■	■	Standard
	5627TB	24	5 W	BA15s	B6			2	B		■	■	Standard
	5637	24	10 W	BA15s	B6			10	C		■	■	Standard
	5637TB	24	10 W	BA15s	B6			2	B		■	■	Standard
5637HD	24	10 W	BA15s	B6			10	C		■	■	Heavy-Duty	
PARKING LIGHT, LICENSE PLATE LIGHT													

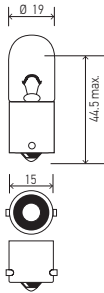

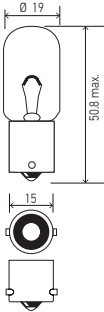

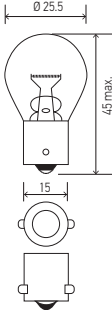

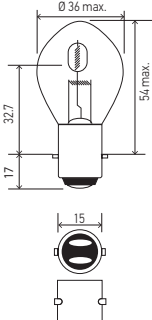

Product Image / Dimensions	Part Number	Voltage	Wattage	Base	Shape	Luminous Flux (lumens)	Kelvin	Content	Packaging	DOT	ECE	INMETRO	Features
BA15s  	1003	12	12 W	BA15s	B6			10	C	■			Standard
	1003LL	12	12 W	BA15s	B6			10	C	■			Long Life
	1308	24	16 W	BA15s	B6					■			Standard
PARKING LIGHT, LICENSE PLATE LIGHT, GLOVE COMPARTMENT LIGHT, TRUNK LIGHT													

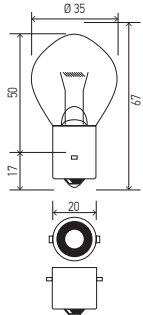
BA15s  	3497	12	25 W	BA15s	T6			10	C	■			Standard
	PARKING LIGHT, LICENSE PLATE LIGHT, GLOVE COMPARTMENT LIGHT, TRUNK LIGHT												

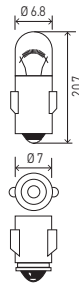
BA15s P21W PY21W  	93	12	13 W	BA15s	S8			10	C	■			Standard
	199	12	29 W	BA15s	S8			10	C	■			Standard (35 MSCP)
	1073	12	23 W	BA15s	S8			10	C	■			Standard
	1141	12	18 W	BA15s	S8			10	C	■			Standard
	1141TB	12	18 W	BA15s	S8			2	B	■			Standard
	1141 24V	24	18 W	BA15s	S8			10	C	■			Standard
	1141 24VSB	24	18 W	BA15s	S8			1	B				Standard
	1141 24VTB	24	18 W	BA15s	S8			2	B				Standard
	1141LL	12	18 W	BA15s	S8			10	C	■			Long Life
	1156	12	27 W	BA15s	S8			10	C	■			Standard
	1156LL	12	27 W	BA15s	S8			10	C	■			Long Life
	1156NA	12	27 W	BA15s	S8			10	C	■			Standard (Nat. amber)
	1683	24	29 W	BA15s	S8			10	C	■			Standard
	2396	12	29 W	BA15s	S8			10	C	■			Standard (40 MSCP)
	7506A	12	21 W	BA15s	S8			10	C			■	Standard (Amber)
	7506	12	21 W	BA15s	S8			10	C		■		Standard
	7506TB	12	21 W	BA15s	S8			2	B		■	■	Standard
	7506ATB	12	21 W	BA15s	S8			2	B		■	■	Standard
	7506ALL	12	21 W	BA15s	S8			10	C				Long Life
	7506LL	12	21 W	BA15s	S8			10	C				Long Life
	7511	24	21 W	BA15s	S8			10	C				Standard
7511TB	24	21 W	BA15s	S8			2	B		■	■	Standard	
7511SB	24	21 W	BA15s	S8			1	B		■	■	Standard	
7506NA	12	21 W	BA15s	S8			10	C		■	■	Standard (Nat. amber)	
FLASHING LIGHT, STOP LIGHT, REAR FOG LIGHT, REVERSE LIGHT, SIGNAL LIGHT													

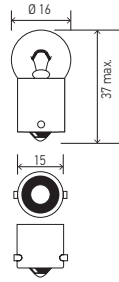
BA20d S2  	6235	12	35/35 W	BA20d	B11			1	C		■		Standard
	6235SB	12	35/35 W	BA20d	B11			1	B				Standard
	6245	12	45/40 W	BA20d	B11			1	C				Standard
	6260	12	60/60 W	BA20d	B11			1	C				Standard (High W.)
LOW BEAM, HIGH BEAM													

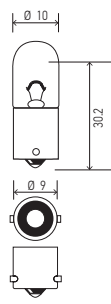

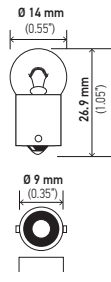
Product Image / Dimensions	Part Number	Voltage	Wattage	Base	Shape	Luminous Flux (lumens)	Kelvin	Content	Packaging	DOT	ECE	INMETRO	Features
BA20s  	660	12	60 W	BA20s	B11			1	C				Standard (High W.)
	635	12	35 W	BA20s	B11			1	C				Standard
LOW BEAM, HIGH BEAM													
BA7s  	3799	6	1 W	BA7s	T2			10	C				Standard
	3898	12	2 W	BA7s	T2			10	C				Standard
	3898TB	12	2 W	BA7s	T2			2	B				Standard
	3899	24	3 W	BA7s	T2			10	C				Standard
DASHBOARD LIGHT													
BA9s  	51	6	12 W	BA9s	G3.5			10	C	■			Standard
	53	12	2 W	BA9s	G3.5			10	C	■			Standard
	53TB	12	2 W	BA9s	G3.5			2	B				Standard
	57	12	3 W	BA9s	G4.5			10	C	■		■	Standard
	265	24	2 W	BA9s	G3.5			10	C	■			Standard
	1445	12	2 W	BA9s	G3.5			10	C	■			Standard
PARKING LIGHT, DASHBOARD LIGHT													
BA9s  	1816	12	4 W	BA9s	T3.25			10	C	■			Standard
	1891	12	3 W	BA9s	T3.25			10	C	■			Standard
	1893	12	5 W	BA9s	T3.25			10	C	■			Standard
PARKING LIGHT													
BA9s  	1895	12	4 W	BA9s	G4.5			10	C	■			Standard
PARKING LIGHT, DASHBOARD LIGHT													

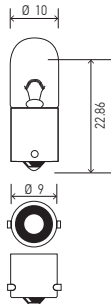
Product Image / Dimensions	Part Number	Voltage	Wattage	Base	Shape	Luminous Flux (lumens)	Kelvin	Content	Packaging	DOT	ECE	INMETRO	Features	
BA9s  	3796	12	2 W	BA9s	T2.75			10	C				Standard	
	3797	24	2 W	BA9s	T2.75			10	C				Standard	
	3797TB	24	2 W	BA9s	T2.75			2	B				Standard	
	3893	12	4 W	BA9s	T2.75			10	C	■	■		Standard	
	3893TB	12	4 W	BA9s	T2.75			2	B	■	■		Standard	
	3893SB	12	4 W	BA9s	T2.75			1	B	■	■		Standard	
	3930	24	4 W	BA9s	T2.75			10	C	■	■		Standard	
	3930TB	24	4 W	BA9s	T2.75			2	B	■	■		Standard	
	PARKING LIGHT													

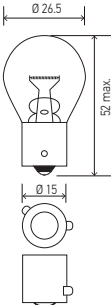
BAU15s P21W PY21W  	7507C	12	21 W	BAU15s	S8			10	C				Standard
	7507CTB	12	21 W	BAU15s	S8			2	B				Standard
	7507	12	21 W	BAU15s	S8			10	C	■	■		Standard
	7507TB	12	21 W	BAU15s	S8			2	B	■	■		Standard
	7510LTS	24	21 W	BAU15s	S8			10	C				Heavy-Duty
	7510LTSTB	24	21 W	BAU15s	S8			2	B				Standard
	9507	24	21 W	BAU15s	S8			10	C	■	■		Standard (Amber)
	9507TB	24	21 W	BAU15s	S8			2	B	■	■		Standard (Amber)
	5009	12	10 W	BAU15s	S8			10	C				Standard
	FLASHING LIGHT AND FRONT, REAR SIDE SIGNAL LIGHT												

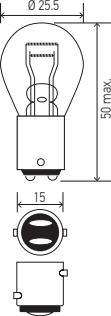
BAY15d  	198HD	12	29/10 W	BAY15d	S8			10	C	■			Heavy-Duty	
	1034	12	23/8 W	BAY15d	S8			10	C	■			Standard	
	1034A	12	23/8 W	BAY15d	S8			10	C	■			Standard (Amber)	
	1034NA	12	23/8 W	BAY15d	S8			10	C	■			Standard (Nat. amber)	
	1034TB	12	23/8 W	BAY15d	S8			2	B	■			Standard	
	1157	12	27/8 W	BAY15d	S8			10	C	■			Standard	
	1157TB	12	27/8 W	BAY15d	S8			2	B	■			Standard	
	1157LL	12	27/8 W	BAY15d	S8			10	C	■			Long Life	
	1157A	12	27/8 W	BAY15d	S8			10	C	■			Standard	
	1157NA	12	27/8 W	BAY15d	S8			10	C	■			Standard (Nat. amber)	
	2057	12	27/7 W	BAY15d	S8			10	C	■			Standard	
	2057LL	12	27/7 W	BAY15d	S8			10	C	■			Long Life	
	2057NA	12	27/7 W	BAY15d	S8			10	C	■			Standard (Nat. amber)	
	2057NALL	12	27/7 W	BAY15d	S8			10	C	■			Long Life (Nat. amber)	
	2357	12	29/8 W	BAY15d	S8			10	C	■			Standard	
	2357LL	12	29/8 W	BAY15d	S8			10	C	■			Long Life	
	2357NA	12	29/8 W	BAY15d	S8			10	C	■			Standard (Nat. amber)	
	2397	12	29/8 W	BAY15d	S8			10	C	■			Standard	
	STOP LIGHT, REAR POSITION LIGHT													

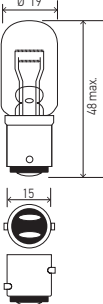
BAY15d  	3496	12	27/8 W	BAY15d	T6			10	C	■			Standard
LOW BEAM, HIGH BEAM, FOG LIGHT (WHERE APPLICABLE)													





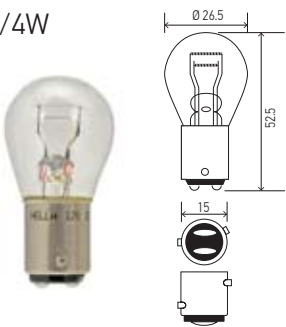

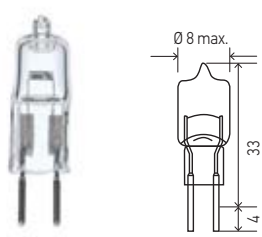

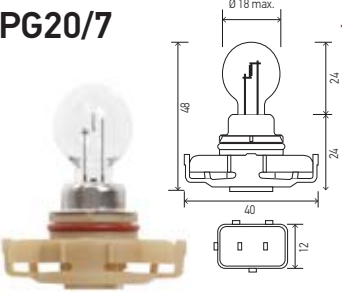

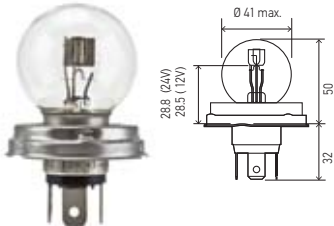

Product Image / Dimensions	Part Number	Voltage	Wattage	Base	Shape	Luminous Flux (lumens)	Kelvin	Content	Packaging	DOT	ECE	INMETRO	Features
BAY15d 	7528	12	21/5 W	BAY15d	S8			10	C	■	■		Standard
	7537	24	21/5 W	BAY15d	S8			10	C				Standard
	7537SB	24	21/5 W	BAY15d	S8			1	B	■	■		Standard
	7537TB	24	21/5 W	BAY15d	S8			2	B	■	■		Standard
	7528TB	12	21/5 W	BAY15d	S8			2	B				Standard
	7528SB	12	21/5 W	BAY15d	S8			1	B				Standard
STOP LIGHT, REAR POSITION LIGHT													

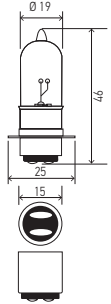
BAZ15d P21/4W 	7225	12	21/4 W	BAZ15d	S8			10	C	■	■		Standard
	7225TB	12	21/4 W	BAZ15d	S8			2	B	■	■		Standard
POSITION LIGHT, REAR FOG LIGHT, STOP LIGHT													

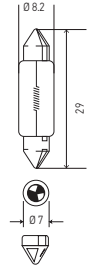
G4 	JC20	12	20 W	G4	T3			10	C				Standard
	JC5	12	5 W	G4	T3			10	C				Standard
	JC10	12	10 W	G4	T3			10	C				Standard
LOW BEAM, HIGH BEAM, FOG LIGHT (WHERE APPLICABLE)													

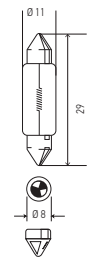
PG20/7 	PSX24W	12	24 W	PG20/7	S8			1	C	■			Standard
LOW BEAM, HIGH BEAM, FOG LIGHT (WHERE APPLICABLE)													

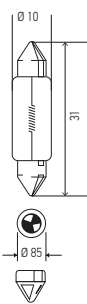
P45t R2 	7951	12	45/40 W	P45t	S13			10	C	■	■		Standard
	7951 55/50W	12	55/50 W	P45t	S13			10	C				Standard
	7952	24	55/50 W	P45t	S13			10	C		■		Standard
	7952TB	24	55/50 W	P45t	S13			2	B		■		Standard
LOW BEAM, HIGH BEAM, FOG LIGHT (WHERE APPLICABLE)													

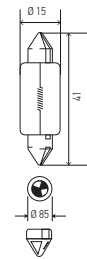
Product Image / Dimensions	Part Number	Voltage	Wattage	Base	Shape	Luminous Flux (lumens)	Kelvin	Content	Packaging	DOT	ECE	INMETRO	Features	
PX15d  	A3603	12	25/25 W	PX15d	T6			1	C				Standard	
	A3625	6	25/25 W	PX15d	T6			1	C				Standard	
LOW BEAM, HIGH BEAM, FOG LIGHT (WHERE APPLICABLE)														
SV7-8  	DE3021	12	3 W	SV7-8	T2.25			10	C	■			Standard (8x29mm)	
	DE3021TB	12	3 W	SV7-8	T2.25			2	B	■			Standard (8x29mm)	
	DE3021SB	12	3 W	SV7-8	T2.25			1	B	■			Standard (8x29mm)	
	DE3022	12	5 W	SV7-8	T2.25			10	C	■			Standard (8x29mm)	
PARKING LIGHT, LICENSE PLATE LIGHT, GLOVE COMPARTMENT LIGHT, INTERIOR LIGHT, TRUNK LIGHT														
SV7-8  	6428	12	3 W	SV7-8	T2.5			10	C				Standard (8x28mm)	
	6430	24	3 W	SV7-8	T2.5			10	C				Standard (8x29mm)	
	6438	12	10 W	SV7-8	T2.5			10	C				Standard (8x31mm)	
PARKING LIGHT, LICENSE PLATE LIGHT, GLOVE COMPARTMENT LIGHT, INTERIOR LIGHT, TRUNK LIGHT														
SV8.5-8  	DE3175	12	10 W	SV8.5-8	T3.25			10	C	■			Standard (10x31mm)	
	DE3175TB	12	10 W	SV8.5-8	T3.25			2	B	■			Standard (10x31mm)	
	DE3175SB	12	10 W	SV8.5-8	T3.25			1	B				Standard (10x31mm)	
	DE3175LL	12	10 W	SV8.5-8	T3.25			10	C				Long Life	
	DE3425	12	10 W	SV8.5-8	T3.25			10	C	■			Standard (13x37mm)	
	6411	12	10 W	SV8.5-8	T3.25			10	C				Standard (10x41mm)	
	6411TB	12	10 W	SV8.5-8	T3.25			2	B				Standard (10x41mm)	
	6411LED 6.5K	12	1 W	SV8.5-8	T3.25			1	B				LED	
	6411LED 5K	12	1 W	SV8.5-8	T3.25			1	B				LED	
	6418	12	5 W	SV8.5-8	T3.25			10	C		■	■	Standard (10x35mm)	
	6418TB	12	5 W	SV8.5-8	T3.25			2	B		■	■	Standard (10x35mm)	
	6418LED 6.5K	12	1 W	SV8.5-8	T3.25			1	B				LED	
	6418LED 5K	12	1 W	SV8.5-8	T3.25			1	B				LED	
	6423	24	5 W	SV8.5-8	T3.25			10	C		■	■	Standard (10x35mm)	
	6423TB	24	5 W	SV8.5-8	T3.25			2	B		■	■	Standard (10x35mm)	
	6429	24	10 W	SV8.5-8	T3.25			10	C				Standard (11x41mm)	
	6429TB	24	10 W	SV8.5-8	T3.25			2	B				Standard (11x41mm)	
	PARKING LIGHT, LICENSE PLATE LIGHT, GLOVE COMPARTMENT LIGHT, INTERIOR LIGHT, TRUNK LIGHT													
	SV8.5-8  	6451	12	15 W	SV8.5-8	T4.625			10	C				Standard (15x44mm)
6453		24	15 W	SV8.5-8	T4.625			10	C				Standard (15x44mm)	
6475		12	18 W	SV8.5-8	T4.625			10	C				Standard (15x41mm)	
6476		12	21 W	SV8.5-8	T4.75			10	C			■	Standard (15x43mm)	
6480		24	18 W	SV8.5-8	T4.625			10	C				Standard (15x43mm)	
PARKING LIGHT, LICENSE PLATE LIGHT, GLOVE COMPARTMENT LIGHT, INTERIOR LIGHT, TRUNK LIGHT														

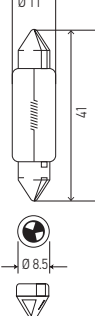

Product Image / Dimensions	Part Number	Voltage	Wattage	Base	Shape	Luminous Flux (lumens)	Kelvin	Content	Packaging	DOT	ECE	INMETRO	Features
SV8.5-8 C5W  	6413	12	5 W	SV8.5-8	T3.25			10	C				Standard (11x41mm)
	6424	24	5 W	SV8.5-8	T3.25			10	C				Standard (11x41mm)
PARKING LIGHT, LICENSE PLATE LIGHT, GLOVE COMPARTMENT LIGHT, INTERIOR LIGHT, TRUNK LIGHT													

W2.1x4.9d

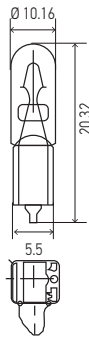

17	24	2 W	W2.1x4.9d	T1.75				10	C	■			Standard
73	12	1.1 W	W2.1x4.9d	T1.75				10	C	■			Standard
73TB	12	1.1 W	W2.1x4.9d	T1.75				2	B	■			Standard
74	12	1.4 W	W2.1x4.9d	T1.75				10	C	■	■		Standard
DASHBOARD LIGHT													

W2.1x9.5d

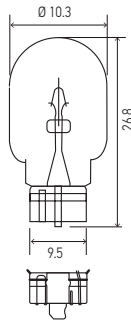





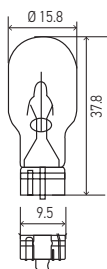



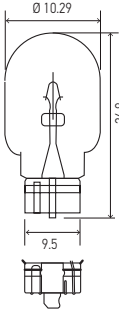

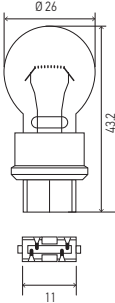

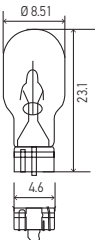

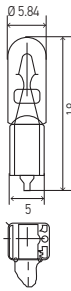

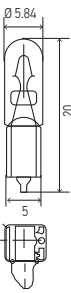

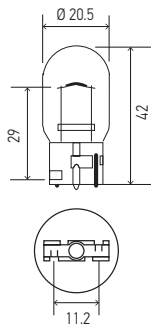

158	12	3 W	W2.1x9.5d	T3.25				10	C	■			Standard
158A	12	3 W	W2.1x9.5d	T3.25				10	C	■			Standard (Amber)
158TB	12	3 W	W2.1x9.5d	T3.25				2	B	■			Standard
168	12	5 W	W2.1x9.5d	T3.25				10	C	■			Standard
168LL	12	5 W	W2.1x9.5d	T3.25				10	C	■			Long Life
168TB	12	5 W	W2.1x9.5d	T3.25				2	B	■			Standard
194	12	4 W	W2.1x9.5d	T3.25				10	C	■			Standard
194B	12	4 W	W2.1x9.5d	T3.25				10	C	■			Standard (Blue)
194NA	12	4 W	W2.1x9.5d	T3.25				10	C	■			Standard (Nat. amber)
194R	12	4 W	W2.1x9.5d	T3.25				10	C	■			Standard (Red)
194LL	12	4 W	W2.1x9.5d	T3.25				10	C	■			Long Life
400	24	3 W	W2.1x9.5d	T3.25				10	C	■			Standard
2840	24	2 W	W2.1x9.5d	T3.25				10	C	■			Standard
DASHBOARD LIGHT													

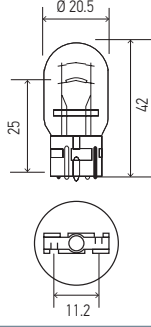
W2.1x9.5d

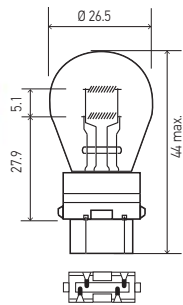

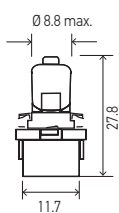
912	12	13 W	W2.1x9.5d	T5				10	C	■			Standard
921	12	16 W	W2.1x9.5d	T5				10	C	■	■		Standard
921NA	12	18 W	W2.1x9.5d	T5				10	C	■	■		Standard
921TB	12	16 W	W2.1x9.5d	T5				2	B	■	■		Standard
921SB	12	16 W	W2.1x9.5d	T5				1	B	■	■		Standard
921LL	12	16 W	W2.1x9.5d	T5				10	C				Long Life
921LED 6.5K	12	1 W	W2.1x9.5d	T5				2	B				LED
921LED 5K	12	1 W	W2.1x9.5d	T5				2	B				LED
PARKING LIGHT													

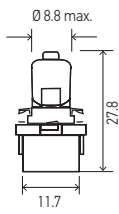

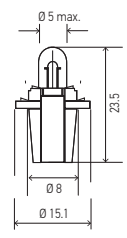



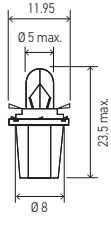

Product Image / Dimensions	Part Number	Voltage	Wattage	Base	Shape	Luminous Flux (lumens)	Kelvin	Content	Packaging	DOT	ECE	INMETRO	Features	
W2.1x9.5d  	2820	12	2 W	W2.1x9.5d	T3.25			10	C				Standard	
	2821	12	3 W	W2.1x9.5d	T3.25			10	C		■	■	Standard	
	2821TB	12	3 W	W2.1x9.5d	T3.25			2	B		■	■	Standard	
	2821SB	12	3 W	W2.1x9.5d	T3.25			1	B		■	■	Standard	
	2825	12	5 W	W2.1x9.5d	T3.25			10	C		■	■	Standard	
	2825BL	12	5 W	W2.1x9.5d	T3.25			10	C				Standard (Blue)	
	2825TB	12	5 W	W2.1x9.5d	T3.25			2	B				Standard	
	2825SB	12	5 W	W2.1x9.5d	T3.25			1	B		■		Standard	
	2827NA	12	5 W	W2.1x9.5d	T3.25			10	C		■	■	Standard (Nat. amber)	
	2827NATB	12	5 W	W2.1x9.5d	T3.25			2	B		■	■	Standard	
	2841	24	3 W	W2.1x9.5d	T3.25			10	C		■	■	Standard	
	2841TB	24	3W	W2.1x9.5d	T3.25			2	B		■	■	Standard	
	2845	24	5 W	W2.1x9.5d	T3.25			10	C				Standard	
	2845SB	24	5 W	W2.1x9.5d	T3.25			1	B		■	■	Standard	
	2845TB	24	5 W	W2.1x9.5d	T3.25			2	B		■	■	Standard	
	3652	12	5 W	W2.1x9.5d	T3.25			10	C				Standard	
	PARKING LIGHT, DASHBOARD LIGHT, LICENSE PLATE LIGHT, GLOVE COMPARTMENT LIGHT, FLASHING LIGHT ADDITIONAL, INTERIOR LIGHT													
	W2.5x16d  	3156	12	27 W	W2.5x16d	S8			10	C	■	■		Standard
3047		12	21/7 W	W2.5x16q	S8			10	C	■			Standard	
3047LL		12	21/7 W	W2.5x16q	S8			10	C	■			Long Life	
3057		12	27/7 W	W2.5x16q	S8			10	C	■			Standard	
3057LL		12	27/7 W	W2.5x16q	S8			10	C	■			Long Life	
3157		12	27/7 W	W2.5x16q	S8			10	C	■	■		Standard	
3157LL		12	27/7 W	W2.5x16q	S8			10	C	■			Long Life	
3157TB		12	27/7 W	W2.5x16q	S8			2	B		■		Standard	
3157NA		12	27/7 W	W2.5x16q	S8			10	C	■			Standard (Nat. amber)	
3457		12	29/8 W	W2.5x16q	S8			10	C	■			Standard	
3457NA		12	29/8 W	W2.5x16q	S8			10	C				Standard (Nat. amber)	
4114LL		12	32/9 W	W2.5x16q	S8			10	C				Long Life	
4157NALL	12	27/7 W	W2.5x16q	S8			10	C				Long Life		
FLASHING LIGHT, REAR SIGNAL LIGHT														
W2x4.6d  	24	12	3 W	W2x4.6d	T2.75			10	C	■			Standard	
	24NA	12	3 W	W2x4.6d	T2.75			10	C	■			Standard (Nat. amber)	
LOW BEAM, HIGH BEAM, FOG LIGHT (WHERE APPLICABLE)														
W2x4.6d  	37	12	1.3 W	W2x4.6d	T1.75			10	C	■			Standard	
	LOW BEAM, HIGH BEAM, FOG LIGHT (WHERE APPLICABLE)													
W2x4.6d  	2721	12	1.2 W	W2x4.6d	T1.5			10	C	■		■	Standard	
	2721TB	12	1.2 W	W2x4.6d	T1.5			2	B	■		■	Standard	
	2722	12	21 W	W2x4.6d	T1.5			10	C			■	Standard	
	2723	12	2.3 W	W2x4.6d	T1.5			10	C		■		Standard	
	2741	24	1.2 W	W2x4.6d	T1.5			10	C				Standard	
	2741TB	24	1.2 W	W2x4.6d	T1.5			2	B				Standard	
DASHBOARD LIGHT														

Product Image / Dimensions	Part Number	Voltage	Wattage	Base	Shape	Luminous Flux (lumens)	Kelvin	Content	Packaging	DOT	ECE	INMETRO	Features
W3x16d  	7440	12	21 W	W3x16d	T6.5			10	C	■	■	■	Standard
	7440LL	12	21 W	W3x16d	T6.5			10	C	■	■	■	Long Life
	7440NA	12	21 W	W3x16d	T6.5			10	C	■	■		Standard (Nat. amber)
	7440NALL	12	21 W	W3x16d	T6.5			10	C	■			Long Life
	7440TB	12	21 W	W3x16d	T6.5			2	B	■			Standard
	7441	12	27 W	W3x16d	T6.5			10	C	■			Standard
	7444NALL	12	21 W	W3x16d	T6.5			10	C	■			Long Life
REAR POSITION LIGHT, STOP LIGHT													
W3x16d  	7443	12	21/5 W	W3x16d	T6.5			10	C	■	■	■	Standard
	7443LL	12	21/5 W	W3x16d	T6.5			10	C	■	■	■	Long Life
	7443A	12	21/5 W	W3x16d	T6.5			10	C	■			Standard (Amber)
	7443NA	12	21/5 W	W3x16d	T6.5			10	C	■			Standard (Nat. amber)
	7443TB	12	21/5 W	W3x16d	T6.5			2	B	■	■	■	Standard
FLASHING LIGHT AND REAR SIGNAL LIGHT, ADDITIONAL FLASHING LIGHT, STOP LIGHT													
W2.5x16q  	3757A	12	27/7 W	W2.5x16q	S8			10	C	■			Standard (Amber)
	3757NALL	12	27/7 W	W2.5x16q	S8			10	C	■			Long Life (Amber)
FLASHING LIGHT AND REAR SIGNAL LIGHT, STOP LIGHT													
B10d  	007997101	12	3 W	B10d				10	C				Brown base
	DASHBOARD LIGHT												
B10d  	007997111	12	5 W	B10d				10	C				Black base
	DASHBOARD LIGHT												
B8.3d  	007997061	24	1.2 W	B8.3d				10	C				Grey base
	DASHBOARD LIGHT												

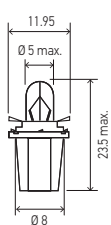

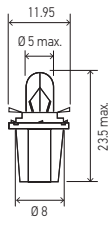
Product Image / Dimensions	Part Number	Voltage	Wattage	Base	Shape	Luminous Flux (lumens)	Kelvin	Content	Packaging	DOT	ECE	INMETRO	Features
B8.3d 	007997001	12	2 W	B8.3d				10	C				White base
	DASHBOARD LIGHT												
B8.5d 	007997031	12	1.2 W	B8.5d				10	C				Black base
	DASHBOARD LIGHT												
B8.3d 	007997041	12	1.2 W	B8.3d				10	C				Black base
	DASHBOARD LIGHT												
B8.5d 	007997071	24	1.2 W	B8.5d				10	C				Grey base
	DASHBOARD LIGHT												
B8.5d 	007997081	12	2 W	B8.5d				10	C				Green base
	DASHBOARD LIGHT												
B8.7d 	007997051	12	2 W	B8.7d				10	C				Grey base
	DASHBOARD LIGHT												
B8.7d 	007997091	12	2 W	B8.7d				10	C				Green base
	DASHBOARD LIGHT												

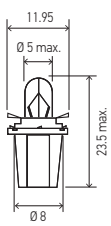

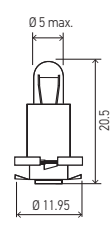
Product Image / Dimensions	Part Number	Voltage	Wattage	Base	Shape	Luminous Flux (lumens)	Kelvin	Content	Packaging	DOT	ECE	INMETRO	Features
BG8.5-5.5d 	007997231	12	1.2 W	BG8.5-5.5d				10	C				Black base
	DASHBOARD LIGHT												
BG8-5.5d 	007997241	12	1.2 W	BG8-5.5d				10	C				Black base
	DASHBOARD LIGHT												
BG8.5-S/40 	007997251	12	1.2 W	BG8.5-S/40				10	C				Black base
	DASHBOARD LIGHT												
BX8.4d  	007997121	12	1.2 W	BX8.4d				10	C				Black base
	DASHBOARD LIGHT												
BX8.4d  	007997131	12	1.5 W	BX8.4d				10	C				Green base
	DASHBOARD LIGHT												
BX8.4d  	007997141	12	1.5 W	BX8.4d				10	C				Beige base
	DASHBOARD LIGHT												
BX8.4d  	007997171	12	1.1 W	BX8.4d				10	C				Orange base
	DASHBOARD LIGHT												

Product Image / Dimensions	Part Number	Voltage	Wattage	Base	Shape	Luminous Flux (lumens)	Kelvin	Content	Packaging	DOT	ECE	INMETRO	Features
BX8.5d  	007997151	12	0.36 W	BX8.5d				10	C				Violet base
DASHBOARD LIGHT													
BX8.5d  	007997161	12	1.5 W	BX8.5d				10	C				Beige base
DASHBOARD LIGHT													
BX8.5d  	007997211	12	1.2 W	BX8.5d				10	C				Blue base
DASHBOARD LIGHT													
BX8.5d  	007997221	12	2 W	BX8.5d				10	C				Light Green base
DASHBOARD LIGHT													
BX8.5d  	007997261	24	1.2 W	BX8.5d				10	C				Brown base
DASHBOARD LIGHT													
EBS N10 	007997272	24	1.2 W	EBS N10				10	C				Grey base
DASHBOARD LIGHT													
EBS R4  	007997191	24	1.2 W	EBS R4				10	C				Yellow base
DASHBOARD LIGHT													

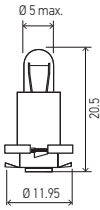

Product Image / Dimensions	Part Number	Voltage	Wattage	Base	Shape	Luminous Flux (lumens)	Kelvin	Content	Packaging	DOT	ECE	INMETRO	Features
EBS R6  	007997201	24	1.2 W	EBS R6				10	C				Brown base
	DASHBOARD LIGHT												
W2x4.6d 	007997011	12	1.2 W	W2x4.6d		T1.5		10	C				White base
	DASHBOARD LIGHT												
W2x4.6d 	007997021	24	1 W	W2x4.6d		T1.5		10	C				White base
	DASHBOARD LIGHT												

SEE THE WORLD WITH DIFFERENT LIGHTS





Mercury Free



With a color temperature of 4300K, twice as bright as halogen bulbs and with about three times their luminous efficiency, the white light of these new generation xenon bulbs ensures safety and relaxed driving.

The new HELLA XENON +30 bulbs have a color temperature of up to 5000K, which rivals white LED daytime running lights, offer maximum illumination and visibility similar to daylight. With a low power consumption of 35W, resistance to vibrations and a long service life.

High Intensity Discharge Lamps (HID)

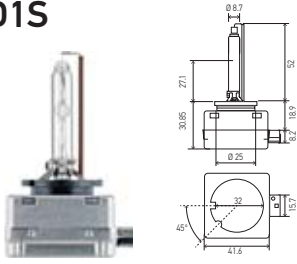
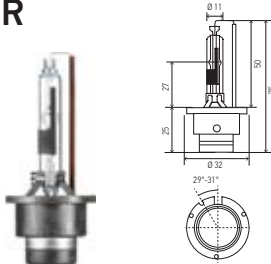
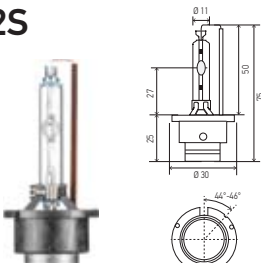
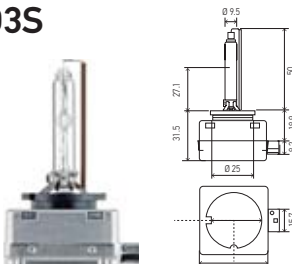
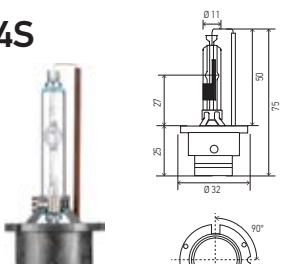
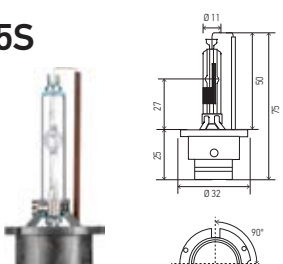
Product Image / Dimensions	Part Number	Voltage	Wattage	Base	Shape	Luminous Flux (lumens)	Kelvin	Content	Packaging	DOT	ECE	INMETRO	Features
	D1S 4300 K	12/24	35 W	PK32d-2	T3	3,200	4300	1	C		■		Standard
	D1S 5000 K	12/24	35 W	PK32d-2	T3		5000	1	C		■		Performance +30
	LOW BEAM, HIGH BEAM												
	D2R 4300 K	12/24	35 W	P32d-3	T3	3,200	4300	1	C		■		Standard
	D2R 5000 K	12/24	35 W	P32d-3	T3	2,800	5000	1	C	■	■		Performance +30
	LOW BEAM, HIGH BEAM												
	D2S 4300 K	12/24	35 W	P32d-2	T2-3/4	3,200	4300	1	C				Standard
	D2S 5000 K	12/24	35 W	P32d-2	T2-3/4		5000	1	C				Performance +30
	LOW BEAM, HIGH BEAM												
	D3S 4300 K	12/24	35 W	P32d-2	T3	3,200	4300	1	C		■		Standard
	LOW BEAM, HIGH BEAM												
		D4S 4300 K	12/24	35 W	P32d-5	T2-3/4	2,800	4300	1	C			
LOW BEAM, HIGH BEAM													
		◆ D5S 4300 K	12/24	25 W	PK32d	T2-3/4	2,800	4300	1	C			
	LOW BEAM, HIGH BEAM												

HELLA BULBS

BLISTER PACKS



HALOGEN SPECIAL BULBS

HELLA develops and manufactures light bulbs for the automotive industry and also has one of the largest retail organizations for auto parts. Our new range of blister packs lets you choose between different styles of light bulbs in a striking design for retail.



STANDARD

STANDARD

- 12 V and 24 V, double and individual blister
- Exclusive high-quality quartz crystal halogen gas formulation
- Original equipment quality
- Excellent luminous efficiency, quality / price
- Complies with global standards (ECE R37, SAE / DOT and INMETRO regulations)



PERFORMANCE

HELLA +50

- 12 V, double blister pack
- Up to 50% more light than standard HELLA bulbs
- Exclusive high-quality quartz crystal halogen gas formulation
- Meets global standards (ECE R37, SAE / DOT and INMETRO regulations).



PERFORMANCE

HIGH PERFORMANCE 2.0

- 12 V, double blister pack
- Up to 100% more light than standard HELLA bulbs
- Exclusive halogen gas and high quality quartz crystal formulation with blue coating
- Meets global standards (ECE R37, SAE / DOT and INMETRO regulations).



DESIGN

XTREME YELLOW

- Improved visibility under foggy, hail and rain conditions, due to its color temperature reduces reflection on objects
- 12 V - Double blister pack
- Exclusive high-quality halogen gas and quartz crystal formulation with yellow coating
- Recommended for vehicles in rural and off-road areas
- For off-road use.



HIGH WATTAGE

HIGH WATTAGE

- 12 V - double and single blister pack
- More light output compared to standard HELLA bulbs
- Excellent luminous efficiency, quality / price ratio
- For off-road use only



HEAVY-DUTY

HEAVY-DUTY / DOUBLE POWER

- 12 V and 24 V- Box, double and single blister pack
- Greater durability and resistance to vibrations compared to standard HELLA bulbs
- Heavy-duty bulbs offer more power and durability by reducing replacement times.



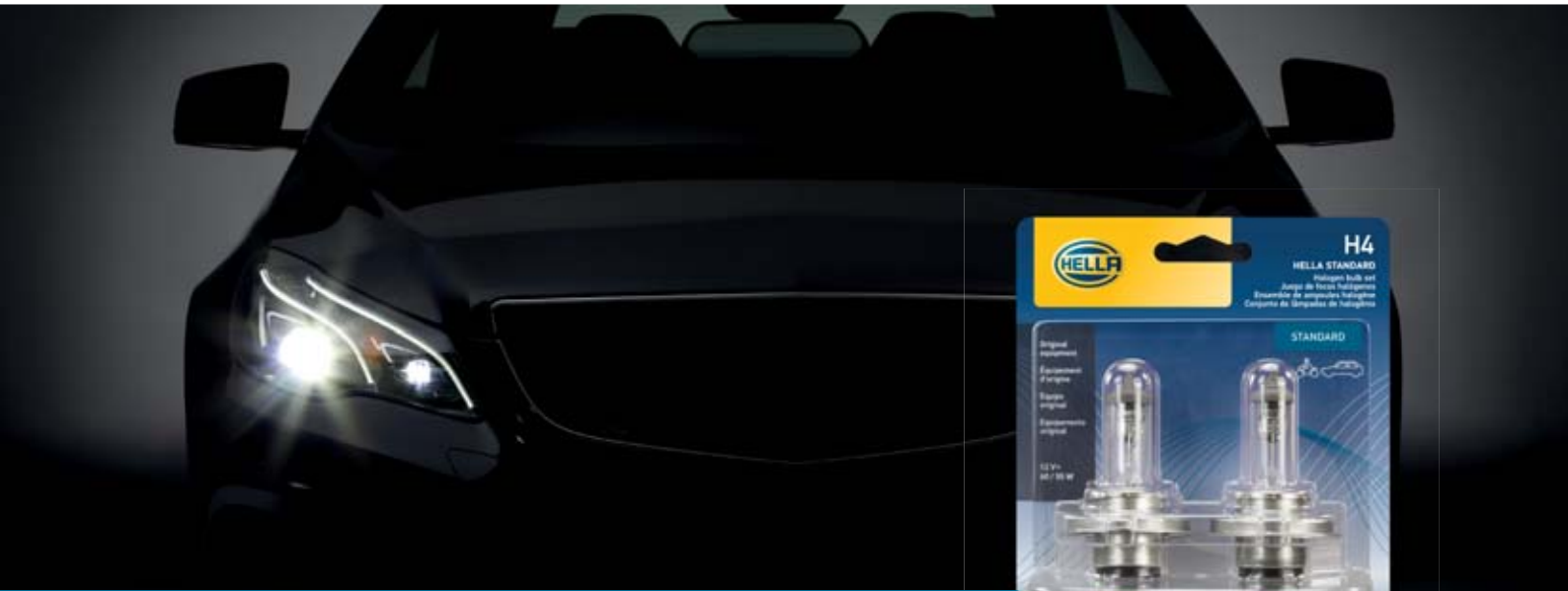

HELLA STANDARD - HALOGEN

HELLA Standard halogen lamps provide original equipment manufacturer quality and a great value for your money. DOT, ECE and inmetro certified*

Note: Please note that bulbs with too high of a wattage can cause the overheating of the wiring and damage to the headlight.

Features:

- Best mixture of light output and reliability
- Original equipment quality
- Excellent luminous efficiency.
- Excellent quality / price

HELLA STANDARD - HALOGEN 12 V

Double Blister Pack



Part Number	Type	Voltage	Wattage	Base	Content	Packaging
9003TB	9003/HB2	12 V	60/55 W	P43t	2	B
9004TB	9004/HB1	12 V	65/45 W	P29t	2	B
9005TB	9005/HB3	12 V	65 W	P20d	2	B
9006TB	9006/HB4	12 V	55 W	P22d	2	B
9007TB	9007/HB5	12 V	65/55 W	PX29t	2	B
H1TB	H1	12 V	55 W	P14.5s	2	B
H10TB	H10	12 V	45 W	PY20d	2	B
H11TB	H11	12 V	55 W	PGJ19-2	2	B
H13TB	H13	12 V	60/55 W	P26.4t	2	B
H3TB	H3	12 V	55 W	PK22s	2	B
H3 35WTB	H3	12 V	35 W	PK22s	2	B
H4TB	H4	12 V	60/55 W	P43t	2	B
H4 35/35WTB	H4	12 V	35/35 W	P43t	2	B
H4 45/45WTB	H4	12 V	45/45 W	P43t	2	B
H4 P45TTB	H4	12 V	60/55 W	P45t	2	B
H7TB	H7	12 V	55 W	PX26d	2	B
H8TB	H8	12 V	35 W	PGJ19-1	2	B
H9TB	H9	12 V	65 W	PGJ19-5	2	B
HS1TB	HS1	12 V	35/35 W	PX43t	2	B
M5 35/35WTB	M5	12 V	35/35 W	P15d-25-1	2	B

Single Blister Pack



Part Number	Type	Voltage	Wattage	Base	Content	Packaging
9003SB	9003/HB2	12 V	60/55 W	P43t	1	B1
9004SB	9004/HB1	12 V	65/45 W	P29T	1	B1
9005SB	9005/HB3	12 V	65 W	P20d	1	B1
9006SB	9006/HB4	12 V	55 W	P22d	1	B1
9007SB	9007/HB5	12 V	65/55 W	PX29t	1	B1
H1SB	H1	12 V	55 W	P14.5s	1	B1
H10SB	H10/9145	12 V	45 W	PY20d	1	B1
H11SB	H11	12 V	55 W	PGJ19-2	1	B1
H13SB	H13	12 V	60/55 W	P26.4t	1	B1
H3SB	H3	12 V	55 W	PK22s	1	B1
H3 35WSB	H3	12 V	35 W	PK22s	1	B1
H4SB	H4	12 V	60/55 W	P43T	1	B1
H4 35/35WSB	H4	12 V	35/35 W	P43T	1	B1
H4 45/45WSB	H4	12 V	45/45 W	P43T	1	B1
H4 P45TSB	H4	12 V	60/55 W	P45t	1	B1
H7SB	H7	12 V	55 W	PX26d	1	B1
H8SB	H8	12 V	35 W	PGJ19-1	1	B1
H9SB	H9	12 V	65 W	PGJ19-5	1	B1
HS1SB	HS1	12 V	35/35 W	PX43t	1	B1
M5 35/35WSB	M5	12 V	35/35 W	P15d-25-1	1	B1
H16SB	H16	12 V	19 W	PGJ19-3	1	B1



HELLA STANDARD - MINIATURE BULBS

Miniature bulbs cover a wide range of mostly low voltage bulb types with unique shapes and bases. HELLA miniature bulbs are manufactured with precise lighting requirements to fit a wide variety of brake lamp, stop lamp, turn signal, and reverse lamp applications. DOT, ECE and inmetro certified*

Features:

- Fits a wide variety of applications
- Excellent luminous efficiency.
- Excellent quality / price

HELLA STANDARD MINIATURE:

Double Blister Pack.



Part Number	Type	Voltage	Wattage	Base	Content	Packaging
7506TB	7506	12 V	21 W	BA15s	2	B
1034TB	1034	12 V	23/8 W	BAY15D	2	B
2825TB	2825	12 V	5 W	W2.1x9.5d	2	B
7528TB	7528	12 V	21/5 W	BAY15d	2	B
921TB	921	12 V	16 W	W2.1x9.5d	2	B
7443TB	7443	12 V	21/5 W	W3X16q	2	B
158TB	158	12 V	3 W	W2.1x9.5d	2	B
5007TB	5007	12 V	5 W	BA15s	2	B
67TB	67	12 V	8 W	BA15s	2	B
3898TB	3898	12 V	2 W	BA7s	2	B
3157TB	3157	12 V	27/7 W	W2.5x16q	2	B
5008TB	5008	12 V	10 W	BA15s	2	B
5637TB	5637	24 V	10 W	BA15s	2	B
3893TB	3893	12 V	4 W	BA9s	2	B
7440TB	7440	12 V	21 W	W3X16d	2	B
7507TB	7507	12 V	21 W	BAU15s	2	B
DE3175TB	3175	12 V	10 W	SV8.5-8	2	B
6411TB	6411	12 V	10 W	SV8.5-8	2	B
2721TB	2721	12 V	1.2 W	W2x4.6d	2	B
168TB	168	12 V	5 W	W2.1x9.5d	2	B

Single Blister Pack.



Part Number	Type	Voltage	Wattage	Base	Content	Packaging
73TB	73	12 V	1.1 W	W2.1x4.9d	2	B
53TB	53	12 V	2 W	BA9s	2	B
1157TB	1157	12 V	27/8 W	BA9s	2	B
7507CTB	7507C	12 V	21 W	BAU15S	2	B
1141TB	1141	12 V	18 W	BA15s	2	B
7506ATB	7506A	12 V	21 W	BA15s	2	B
6418TB	6418	12 V	5 W	SV8.5-8	2	B
DE3021TB	3021	12 V	3 W	SV7-8	2	B
7225TB	7225	12 V	21/4 W	BAZ15d	2	B
2827NATB	2827NA	12 V	5 W	W2.1x9.5d	2	B
2821TB	2821	12 V	3 W	W2.1x9.5d	2	B
2825SB	2825	12 V	5 W	W2.1x9.5d	1	B1
7528SB	7528	12 V	21/5 W	BAY15d	1	B1
921SB	921	12 V	16 W	W2.1x9.5d	1	B1
5007SB	5007	12 V	5 W	BA15s	1	B1
5008SB	5008	12 V	10 W	BA15s	1	B1
3893SB	3893	12 V	4 W	BA9s	1	B1
DE3175SB	3175	12 V	10 W	SV8.5-8	1	B1
6235SB	6235	12 V	35/35 W	BA20d	1	B1
DE3021SB	3021	12 V	35/35 W	SV7-8	1	B1
2821SB	2821	12 V	3 W	W2.1x9.5d	1	B1



HELLA STANDARD - 24 V

In a convenient presentation, HELLA presents its range of 24 V products in plastic blister packs with the same Original Equipment quality in both halogen bulbs and miniature bulbs.

Features:

- Double blister pack and single blister
- Original equipment quality
- Excellent luminous efficiency. Excellent quality / price
- Meets global standards (ECE R37, SAE / DOT and INMETRO)

HELLA STANDARD 24 V:

Double Blister Pack.



Part Number	Type	Voltage	Wattage	Base	Content	Packaging
1141 24VTB	1141	24 V	18 W	BA15s	2	B
2741TB	2741	24 V	1.2 W	W2x4.6d	2	B
2841TB	2841	24 V	3 W	W2.1x9.5d	2	B
2845TB	2845	24 V	5 W	W2.1x9.5d	2	B
3797TB	3797	24 V	2 W	BA9s	2	B
3930TB	3930	24 V	4 W	BA9s	2	B
5627TB	5627	24 V	5 W	BA15s	2	B
6423TB	6423	24 V	5 W	SV8.5-8	2	B
6429TB	6429	24 V	10 W	SV8.5-8	2	B
7510LTSTB	7510LTS	24 V	21 W	BAU15s	2	B
7511TB	7511	24 V	21 W	BA15s	2	B
7534TB	7534	24 V	21/5 W	BA15d	2	B
7537TB	7537	24 V	21/5 W	BAY15d	2	B
7952TB	7952	24 V	55/50 W	P45t	2	B
9507TB	9507	24 V	21 W	BAU15s	2	B
H1 24VTB	H1	24 V	70 W	P14.5s	2	B
H11 24VTB	H11	24 V	70 W	PGJ19-2	2	B
H3 24VTB	H3	24 V	70 W	PK22s	2	B
H4 24VTB	H4	24 V	75/70 W	P43t	2	B
H7 24VTB	H7	24 V	70 W	PX26d	2	B
H9 24VTB	H9	24 V	80 W	PGJ19-5	2	B

Single Blister Pack.



Part Number	Type	Voltage	Wattage	Base	Content	Packaging
1141 24VSB	1141	24 V	18 W	BA15s	1	B1
2845SB	2845	24 V	5 W	W2.1x9.5d	1	B1
5627SB	5627	24 V	5 W	BA15s	1	B1
7511SB	7511	24 V	21 W	BA15s	1	B1
7537SB	7537	24 V	21/5 W	BAY15d	1	B1
H1 24VSB	H1	24 V	70 W	P14.5s	1	B1
H11 24VSB	H11	24 V	70 W	PGJ19-2	1	B1
H3 24VSB	H3	24 V	70 W	PK22s	1	B1
H4 24VSB	H4	24 V	75/70 W	P43t	1	B1
H7 24VSB	H7	24 V	70 W	PX26d	1	B1
H9 24VSB	H9	24 V	80 W	PGJ19-5	1	B1



LONG LIFE

The special design of Long Life bulbs for passenger cars guarantees a longer service life, more light performance and reduced energy consumption, making them ideal for frequent drivers and permanent use of daytime running lights. Long Life represents bright but glare-free light. Good performance under extreme conditions for construction machinery or off-road vehicles.

Long Life combines unusual sturdiness and vibration resistance with convincing brightness and long service life.

Features:

- Up to 200% longer life time than HELLA standard bulbs.
- Special mixture of halogen gases to achieve high durability and increase life time
- Meets global standard (ECE R37 & SAE/DOT regulation).
- Color temperature 3,200 K

Some examples of the product range:



H4 24LL



H13LL

HELLA LONG LIFE:

Part Number	Type	Voltage	Wattage	Base	Shape	Luminous Flux (lumens)	Content	Packaging	DOT	ECE	INMETRO
H1LL	H1	12 V	55 W	P14.5s	T2.5	1550	1	C	■	■	■
H4 24V LL	H4	24 V	75/70 W	P43t	T4.625	1900/1200	1	C	■	■	■
H7 24V LL	H7	24 V	70 W	PX26d	T4.625	1750	1	C	■	■	■
H7LL	H7	12 V	55 W	PX26d	T4.625	1500	1	C	■	■	■
H11LL	H11	12 V	55 W	PGJ19-2	T4	1350	1	C	■	■	
9003LL	9003	12 V	60/55 W	P43t	T4.625	1500/910	1	C	■		
9004LL	9004	12 V	65/45 W	P29t	T4.625	1200/700	1	C	■		■
9005LL	9005	12 V	65 W	P20d	T4	1860	1	C	■	■	■
9006LL	9006	12 V	55 W	P22d	T4	1095	1	C	■	■	■
9007LL	9007	12 V	65/55 W	PX29t	T4.625	1350/1000	1	C	■		
1003LL	1003	12 V	12 W	BA15s	B6		1	C	■		
1141LL	1141	12 V	18 W	BA15s	S8		1	C	■		
1156LL	1156	12 V	27 W	BA15s	S8		1	C	■		
1157LL	1157	12 V	27/8 W	BAY15d	S8		1	C	■		
2057LL	2057	12 V	27/7 W	BAY15d	S8		1	C	■		
2057NALL	2057	12 V	27/7 W	BAY15d	S8		1	C	■		
2357LL	2357	12 V	29/8 W	BAY15d	S8		1	C	■		
3047LL	3047	12 V	21/7 W	W2.5X16q	S8		1	C	■		
3157LL	3157	12 V	27/7 W	W2.5x16q	S8		1	C	■	■	
7440LL	7440	12 V	21 W	W3X16d	T6.5		1	C	■	■	■
7443LL	7443	12 V	21/5 W	W3X16q	T6.5		1	C	■	■	■
9012LL	9012	12 V	55 W	PX22d	T4		1	C	■	■	
◆ 3757NALL	3757	12 V	27/7 W	W2.5X16q	S8		1	C	■	■	



HIGH PERFORMANCE 2.0

HELLA's HP 2.0 Bulbs have been re-engineered to produce a brighter, whiter light which allows the driver to see more contrast in objects on the road, increasing safety and reaction time. These DOT compliant bulbs have been manufactured under strict HELLA guidelines and are an optimal balance of bulb performance and bulb life. The new HP 2.0 kits contain everything you need to get the job done.

Features:

- 12 V - Double Blister Pack
- Up to 100% more light than HELLA standard bulbs
- Meets global standard (ECE R37 & SAE/DOT and INMETRO regulation).
- Specially designed by halogen mixing gas & filament.
- Color temperature: 3,600 K

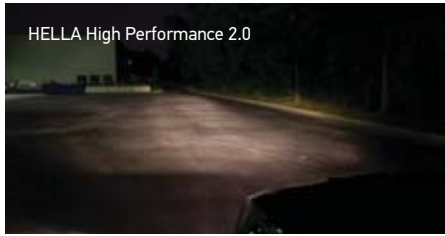

HELLA HIGH PERFORMANCE 2.0:

Part Number	Type	Voltage	Wattage	Base	Content	Packaging	DOT	ECE	INMETRO
H1 2.0TB	H1	12 V	55 W	P14.5s	2	B	■	■	007691/2013
H3 2.0TB	H3	12 V	55 W	PK22s	2	B	■	■	007696/2013
9003 2.0TB	H4 HB2 9003	12 V	60/55 W	P43t	2	B	■	■	007697/2013
H7 2.0TB	H7 12V	12 V	55 W	PX26d	2	B	■	■	007698/2013
H9 2.0TB	H9 12V	12 V	65 W	PGJ19-5	2	B	■	■	-
H11 2.0TB	H11 12V	12 V	55 W	PGJ19-2	2	B	■	■	-
H13 2.0TB	H13 9008	12 V	60/55 W	P26.4t	2	B	■	■	-
9004 2.0TB	9004 HB1	12 V	65/45W	P29t	2	B	■	■	007699/2013
9005 2.0TB	9005 HB3	12 V	65 W	P20d	2	B	■	■	007700/2013
9006 2.0TB	9006 HB4	12 V	55 W	P22d	2	B	■	■	007701/2013
9007 2.0TB	9007 HB5	12 V	65/55W	PX29t	2	B	■	■	-





HELLA +50

The HELLA +50 version produces 50 percent more light (compared to standard bulbs*) and extends the light cone, giving performance-oriented drivers additional safety time in case of an emergency situation.

Features:

- Up to 50% more light output than HELLA standard bulbs
- Meets global standard (ECE R37 & SAE/DOT and INMETRO regulation).
- Filament design optimized
- Wider and brighter light
- OE quality
- With silver top coating to be invisible in the headlight

Some examples of the product range:

HELLA +50:

Part Number	Type	Voltage	Wattage	Base	Shape	Luminous Flux (lumens)	Content	Packaging	DOT	ECE	INMETRO
H1P50	H1	12 V	55 W	P14.5s	T2.5	1700	1	C	■	■	■
H1P50TB	H1	12 V	55 W	P14.5s	T2.5	1700	2	B	■	■	■
H3P50	H3	12 V	55 W	PK22s	T3.25	1600	1	C	■	■	■
H3P50TB	H3	12 V	55 W	PK22s	T3.25	1600	2	B	■	■	■
H4P50	H4	12 V	60/55 W	P43t	T4.625	1815/1100	1	C		■	■
H4P50TB	H4	12 V	60/55 W	P43t	T4.625	1815/1100	2	B		■	■
H7P50	H7	12 V	55 W	PX26d	T4.625	1560	1	C	■	■	■
H7P50TB	H7	12 V	55 W	PX26d	T4.625	1560	2	B	■	■	■
H11P50	H11	12 V	55 W	PGJ19-2	T4	1450	1	C	■	■	
H11P50TB	H11	12 V	55 W	PGJ19-2	T4	1450	2	B	■	■	
H13P50	H13	12 V	60/55 W	P26.4t	T4	1650/1100	1	C	■	■	
H13P50TB	H13	12 V	60/55 W	P26.4t	T4	1650/1100	2	B	■	■	
9004P50	9004	12 V	65/45 W	P29t	T4.625	1250/765	1	C	■		■
9004P50TB	9004	12 V	65/45 W	P29t	T4.625	1250/765	2	B	■		■
9005P50	9005	12 V	65 W	P20d	T4	2000	1	C	■	■	■
9005P50TB	9005	12 V	65 W	P20d	T4	2000	2	B	■	■	■
9006P50	9006	12 V	55 W	P22d	T4	1200	1	C	■	■	■
9006P50TB	9006	12 V	55 W	P22d	T4	1200	2	B	■	■	■
9007P50	9007	12 V	65/55 W	PX29t	T4.625	1450	1	C	■		
9007P50TB	9007	12 V	65/55 W	PX29t	T4.625	1450	2	B	■		



H4P50



H13P50



HIGH WATTAGE

The ideal bulbs for professionals who travel off-road, or have a special demand for high power. Such as those in agriculture or forestry, or on building sites. In addition, HELLA bulbs have been involved in many victories in 24-hour races.

Note: Please note that bulbs with too high of a wattage can cause the overheating of the wiring and damage to the headlight.

Features:

- Box, double and single blister pack
- Longer service life compared to standard HELLA bulbs
- Environmentally friendly, because they do not have to be replaced as often.
- Excellent luminous efficiency.
- Excellent quality / price
- For off-road use only

HELLA HIGH WATTAGE:

Part Number	Type	Voltage	Wattage	Base	Shape	Luminous Flux (lumens)	Content	Packaging	DOT	ECE	INMETRO
H1 100W	H1	12 V	100 W	P14.5s	T2.5	1850	1	C			
H1 100WTB	H1	12 V	100 W	P14.5s	T2.5	1850	2	B			
H1 130W	H1	12 V	130 W	P14.5s	T2.5	2400	1	C			
H2 100W	H2	12 V	100 W	X511	T3		1	C			
H3 100W	H3	12 V	100 W	PK22s	T3.25	1850	1	C			
H3 100WTB	H3	12 V	100 W	PK22s	T3.25	1850	2	B			
H3 130W	H3	12 V	130 W	PK22s	T3.25	2600	1	C			
H3 130WTB	H3	12 V	130 W	PK22s	T3.25	2600	2	B			
H3 24V 100W	H3	24 V	100 W	PK22s	T3.25	2500	1	C			
H4 100/55W	H4	12 V	100/55 W	P43t	T4.625	2400/1000	1	C			
H4 100/55WTB	H4	12 V	100/55 W	P43t	T4.625	2400/1000	2	B			
H4 100/80W	H4	12 V	100/80 W	P43t	T4.625		1	C			
H4 100/80WTB	H4	12 V	100/80 W	P43t	T4.625		2	B			
H4 130/90W	H4	12 V	130/90 W	P43t	T4.625	3200/1600	1	C			
H4 130/90WTB	H4	12 V	130/90 W	P43t	T4.625	3200/1600	2	B			
H4 24V 100/90W	H4	24 V	100/90 W	P43t	T4.625		1	C			
H7 100W	H7	12 V	100 W	PX26d	T4.625	2000	1	C			
H7 100WTB	H7	12 V	100 W	PX26d	T4.625	2000	2	B			
H7 70W	H7	12 V	70 W	PX26d	T4.625	1800	1	C			
9004 100/80W	9004	12 V	100/80 W	P29t	T4.625	1600/1300	1	C			
9005 100W	9005	12 V	100 W	P20d	T4	2200	1	C			
9006 80W	9006	12 V	80 W	P22d	T4	1650	1	C			
9007 100/80W	9007	12 V	100/80 W	PX29t	T4.625	1800/1500	1	C			
H4 100/80WSB	H4	12 V	100/80 W	P43t	T4.625		1	B1			
9007 100/80WSB	9007	12 V	100/80 W	PX29t	T4.625	1800/1500	1	B1			
9004 100/80WSB	9004	12 V	100/80 W	P29t	T4.625	1600/1300	1	B1			
9006 80WSB	9006	12 V	80 W	P22d	T4	1650	1	B1			
9005 100WSB	9005	12 V	100 W	P20d	T4	2200	1	B1			

C = Box B = Blister Pack B1 = Single Blister Pack P = Plastic Case ◆ = New Product

Some examples of the product range:



9005 100W



9004 100/80W



HEAVY-DUTY | DOUBLE POWER

Durability, resistance to vibration with 24V power produces excellent light in a single filament. Heavy-Duty bulbs offer more power, more safety, without dazzling vehicles. Thanks to its power and increased lifespan, the replacement costs are reduced drastically.

Features:

- Increased vibration resistance
- All advantages of standard bulbs
- Reduced downtime cost due to less bulb changes

Some examples of the product range:

HELLA HEAVY-DUTY:

Part Number	Type	Voltage	Wattage	Base	Shape	Luminous Flux (lumens)	Content	Packaging	DOT	ECE	INMETRO
198HD	198	12 V	29/10 W	BAY15d	S8		10	C	■		
5637HD	5637	24 V	10 W	BA15s	B6		10	C		■	■
7510LTS	PY21W	24 V	21 W	BAU15s	S8		10	C			
H3 24V HD	H3	24 V	70 W	PK22s	T3.25	1750	1	C		■	■
H3HD	H3	12 V	55 W	PK22s	T3.25	1450	1	C	■	■	■
H3 24V HDSB	H3	24 V	70 W	P43t	T3.25	1900/1200	1	B		■	■
H3 24V HDTB	H3	24 V	70 W	P43t	T3.25		2	B		■	■
H4 24V HD	H4	24 V	75/70 W	PK22s	T4.625		1	C		■	■
H4 24V HDSB	H4	24 V	75/70 W	PK22s	T4.625		1	B		■	■
H4 24V HDTB	H4	24 V	75/70 W	PK22s	T4.625		2	B		■	■



H4 24V HD

HELLA DOUBLE POWER:

H1 24V DP	H1	24 V	70 W	P14.5s	T2.5		1	C		■	■
H3 24V DP	H3	24 V	70 W	PK22s	T3.25		1	C		■	■
H4 24V DP	H4	24 V	70/75 W	P43t	T4.625		1	C		■	■
H7 24V DP	H7	24 V	70 W	PX26d	T4.625		1	C		■	■
H11 24V DP	H11	24 V	70 W	PGJ19-2	T4		1	C		■	
H1 24V DPSB		24 V	70 W	P14.5s	T2.5		1	B		■	■
H3 24V DPSB		24 V	70 W	PK22s	T3.25		1	B		■	■
H4 24V DPSB		24 V	75/70 W	P43t	T4.625		1	B		■	■
H7 24V DPSB		24 V	70 W	PX26d	T4.625		1	B		■	■
H11 24V DPSB		24 V	70 W	PGJ19-2	T4		1	B		■	



H3HD



OPTILUX EXTREME YELLOW XY - 12V

The XY Optilux bulbs are designed to give better visibility in extreme weather conditions. Pilots races prefer a yellow light beam, which provides better color contrast in rain and fog situations. The XY Optilux bulbs produce a clear yellow light their filament is made of specific measures to provide the exact amount of light needed in the way.

Features:

- All bulbs are Optilux 12V.
- Two bulbs packed in hard plastic.
- For off-road use

Some examples of the product range:



Part Number	Type	Voltage	Wattage	Base
H71071172	880	12V	27 W	PG13
H71071182	881	12V	27 W	PGJ13
◆ H71071192	893	12V	37.5 W	PG13
◆ H71071462	9006	12V	55 W	P22d**
H71071532	9011	12V	65 W	PX20d
H71071542	9012	12V	55 W	PX22d
H71070642	H1	12V	55 W	P14.5s
◆ H71071112	H10	12V	42 W	PY20d
H71071132	H11	12V	55 W	PGJ19-2
H71071552	H11B	12V	65W	PGJY19-2
H71071152	H13	12V	60/55 W	P26.4t
H71071302	H16	12V	35 W	PG20-3
H71070662	H3	12V	55 W	PK22s
H71071342	H3C	12V	55 W	P22d
H71070682	H4/9003	12V	60/55 W	P43t
H71070702	H7	12V	55 W	PX26d
H71071072	H8	12V	35 W	PGJ19-1
H71071092	H9	12V	65 W	PGJ19-5
H71070562	HB1	12V	65/45 W	P29t
H71070582	HB3	12V	65 W	P20d
H71070602	HB4	12V	55 W	P22d
H71070622	HB5	12V	60/55 W	PX29t



OPTILUX EXTREME WHITE XB - 12V

See the light!

Extreme White bulbs XB Optilux give a radical look at the xenon light in a halogen bulb, with its blue coating. These bulbs incorporate gas xenon bulb improved performance

Features:

- All bulbs are Optilux 12V.
- Two bulbs packed in hard plastic.
- For off-road use



Part Number	Type	Voltage	Wattage	Base	Part Number	Type	Voltage	Wattage	Base
H71071212	880	12V	32 W	PG13	◆ H71071052	H13	12V	100/80 W	P26.4t
H71071222	881	12V	32 W	PGJ13	H71071272	H13	12V	60/55 W	P26.4t
H71071232	893	12V	37.5 W	PG13	H71071282	H16	12V	35 W	PG20-3
H71071392	9004	12V	65/45 W	P29t	H71070227	H2	12V	100 W	P14.5s
H71071402	9005	12V	65 W	P20d	H71070181	H3	12V	100 W	PK22s
H71071412	9005	12V	65 W	P20d**	H71071312	H3	12V	55 W	PK22s
H71071422	9005	12V	100 W	P20d**	H71071322	H3C	12V	55 W	P22d
H71071432	9006	12V	55 W	P22d	H71071332	H3C	12V	80 W	P22d
H71071442	9006	12V	55 W	P22d**	H71070201	H4/9003	12V	100/80 W	P43t
H71071452	9006	12V	80 W	P22d**	H71071352	H4/9003	12V	60/55 W	P43t
H71071472	9007	12V	65/55 W	PX29t	H71070307	H7	12V	100 W	PX26d
H71071492	9011	12V	65 W	PX20d	H71071362	H7	12V	55 W	PX26d
H71071502	9012	12V	55 W	PX22d	H71070772	H8	12V	55 W	PGJ19-1
H71071242	H1	12V	55 W	P14.5s	H71071372	H8	12V	35 W	PGJ19-1
H71071012	H10	12V	65 W	PY20d	H71070792	H9	12V	100 W	PGJ19-5
H71071252	H10	12V	42 W	PY20d	H71071382	H9	12V	65 W	PGJ19-5
H71071032	H11	12V	80 W	PGJ19-2	H71070327	HB1	12V	100/80 W	P29t
H71071262	H11	12V	55 W	PGJ19-2	H71070347	HB3	12V	100 W	P20d
H71071512	H11B	12V	65W	PGJY19-2	H71070367	HB4	12V	80 W	P22d
					H71070387	HB5	12V	100/80 W	PX29t





LIGHT UP THE WAY

TWO WHEELERS



1 FRONT LIGHT LOW BEAM HIGH BEAM

HS1	H3 35W	H8 H8XE-DB	H4 35/35W M H4 60/55W M	H7
H8	H9	H11 H11P50 H11LL	M5	HS1 / H4
6235	M5 25/25W3	M5 35/35W3	M5 35/35W1	M5 25/25W
H21W	M5 18/18W M5 35/35W	M5 25/25W1		

2 SIGNAL LIGHT FRONT REAR

H21W	921 W16W	2821	2825 W5W	7440 W21W	7440NA WY21W	7443	1157LED
1891	5007 R5W	5008 R10W	5009A R10W	7506 1141 P21W	7528 1034 P21/5W	7507 1034A PY21W	

3 FRONTAL PARKING LIGHT

3893 T4W	5007 R5W	5008 R10W	H6W	194 W3W	2845 W5W	921 W16W



4 STOP LIGHT

7528 P21/5W	7506 P21W	921 W16W	7443 W21/5W	5007 R5W
1157RLED	7443WLED	194WLED	1141	1034 A

5 LICENSE PLATE LIGHT

6413 C5W	H6W	5007 R5W	194 W3W	2825 W5W	5008 R10W	3893 T4W



7 POSITION LIGHT

7528 P21/5W	7507	2721	3796	DE3175	6413	7537 P21/5W	7506 P21W	7443 W21/5W	194 W3W	2845 W5W	3893 T4W	5007 R5W	5008 R10W



HELLA has the most complete line of lighting for cars, trucks, buses and now for motorcycles, scooters, mopeds and ATVs.

As original equipment, HELLA is found in most of the car manufacturers, this means that we guarantee 100% light according to the technical standards, offering a long life and in perfect harmony with the whole vehicle. In addition, HELLA halogen bulbs have a UV filter that protects the headlight lens by blocking UV rays, which prevents yellowing of the lens.

BULBS FOR MOTORCYCLES



BULBS FOR MOTORCYCLES

For the wide range of motorcycles, scooters, mopeds and ATVs, HELLA offers precise solutions according to the requirements of original equipment.

Because it is particularly important for drivers of two-wheel vehicles to see and be seen...

Note:

In headlights, particularly in the case of motorcycles large motor or large displacement is common to find halogen bulbs with identical specification to those of automotive application (H4 60/55, H7 55W, 9006 55W, 9006 HXS 55W, etc.)



Part Number	Type	Voltage	Wattage	Base	Shape	Luminous Flux (lumens)	Content	Packaging	DOT	ECE	INMETRO
880XE-35DB	880	12 V	35 W	PG13	T3.25		1	C			
889XE-35DB	894	12 V	35 W	PGJ13	T3.25		1	C			
H3 35W	H3	12 V	35 W	PK22s	T3.25		1	C			
H8	H8	12 V	35 W	PGJ19-1	T4		1	C	■	■	
H8XE-DB	H8	12 V	35 W	PGJ19-1	T4		1	C			
HS1	HS1	12 V	35 / 35 W	PX43t	T4.625		1	C		■	
H4 35/35W	H4	12 V	35/35 W	P43t	T4.625		1	C			
H4 45/45W	H4	12 V	45/45 W	P43t	T4.625		1	C			
6235	S2	12 V	35/35 W	BA20d	B11		1	C			■
6245	S2	12 V	45/40 W	BA20d	B11		1	C			
A3603	3603	12 V	25/25 W	PX15d	T6		1	C			
6260	S2	12 V	60/60 W	BA20d	B11		1	C			
A3625	3625	6 V	25/25 W	PX15d	T6		1	C			
635	F2	12 V	35 W	BA20s	B11		1	C			
660	660	12 V	60 W	BA20s	B11		1	C			
7951	R2	12 V	45/40 W	P45t	S13		1	C			
7952	R2	24 V	55/50 W	P45t	S13		1	C			
H9	H9	12 V	65 W	PGJ19-5	T4		1	C	■	■	
H11	H11	12 V	55 W	PGJ19-2	T4		1	C	■	■	
H11P50	H11	12 V	55 W	PGJ19-2	T4		1	C	■	■	
H11LL	H11	12 V	55 W	PGJ19-2	T4		1	C	■	■	
H21W	H21W	12 V	21 W	BAY9s	T2.75		1	C		■	■
H6W	H6W	12 V	6 W	BAX9s	T2.75		1	C		■	
2820	2820	12 V	2 W	W2.1x9.5d	T3.25		10	C			
2821	2821	12 V	3 W	W2.1x9.5d	T3.25		10	C		■	■
2825	2825	12V	5 W	W2.1x9.5d	T3.25		10	C		■	■
2825BL	2825BL	12 V	5 W	W2.1x9.5d	T3.25		10	C			
2827NA	2827NA	12 V	5 W	W2.1x9.5d	T3.25		10	C			
3652	3652	12 V	5 W	W2.1x9.5d	T3.25		10	C		■	■
7440	7440	12 V	21 W	W3X16d	T6.5		10	C	■	■	■
7440LL	7440	12 V	21 W	W3X16d	T6.5		10	C	■	■	■
7440NA	7440	12 V	21 W	W3X16d	T6.5		10	C	■	■	■
7441	7441	12 V	27 W	W3X16d	T6.5		10	C	■	■	
3893	3893	12 V	4 W	BA9s	T2.75		10	C	■	■	
194	194	12 V	4 W	W2.1x9.5d	T3.25		10	C	■		
194NA	194	12 V	4 W	W2.1x9.5d	T3.25		10	C	■		
7507C	7507	12 V	21 W	BAU15s	S8		10	C		■	■
7507	7507	12 V	21 W	BAU15s	S8		10	C		■	■
2721	2721	12 V	1.2 W	W2x4.6d	T1.5		10	C	■		■

Some examples of the product range:



6235



660



7951

LED Retrofit

Motorcycle range

Elegant look with daylight effect

With our LED Retrofit program, motorcycle lighting can be converted to the latest LED technology. The new LED Retrofits offer exceptional luminosity, and thanks to the optimized light distribution, there is more light on the road where it is needed. A longer service life than halogen headlights makes LED Retrofits attractive to all motorcyclists.

The stylish image with a cool white beam gives motorcyclists a daylight effect at night and more comfort and fun when riding. Our LED Retrofit range includes low and high beams for motorcycle headlights. See and be seen – that's our motto!

Standard lamp



HELLA LED lamp



LED
UPGRADE



Product Range



LED (~ HS1 / H4 Moto)

226971581 1 piece. 12V 6W P43t 6.500 K

LED (~ M5 Moto)

226971591 1 piece 12V 6W P15d-25-1 6.500 K



ADDITIONAL INFORMATION



Displays



Pre-stocked bulb display

Ask your sales representative for the new HELLA displays and get them now!

- Metal frame with 4 shelves and acrylic window
- Shelving is adjustable inside the cabinet
- Durable and elegant design
- Contents: H7 (24 packs), H3 24V (4 packs), 9003 (6 packs), H11 (4 packs), H1 (4 packs), H3 (4 packs), 2 boxes of 10 pcs of the following bulbs: 3157, 194, 7506, 921 and 3898

Part Number	Description
999942461	Pre-stocked bulb display. Dimensions: 44.5x 17.5x 54 cm (17.5 x 6.88 x 21.2")



Bulbs cabinet for miniature bulbs

Ask your sales representative for the new HELLA displays and get them now!

- Manufactured in semi-matte black steel.
- Its compartments come in stackable and individual shapes to maximize organization.
- The miniature bulb dispenser cabinet includes 4 plastic drawers, dividers to make 28 slots for light bulbs
- Storage space "behind" the label
- Durable and elegant design

Part Number	Description
999141848	Cabinet Display. Dimensions: 48.2 x 10.1 x 68.5 cm (18.97 x 3.97 x 26.9")



Blister display

- Manufactured in semi-matte black steel.
- Its 8 hooks allow you to hang up to 40 blisters in total.

Part Number	Description
999942713	Hanging blister display.
999942615	Counter top blister display
	Dimensions: 52 x 22 x 55.5 cm (20.47 x 8.66 x 21.85")

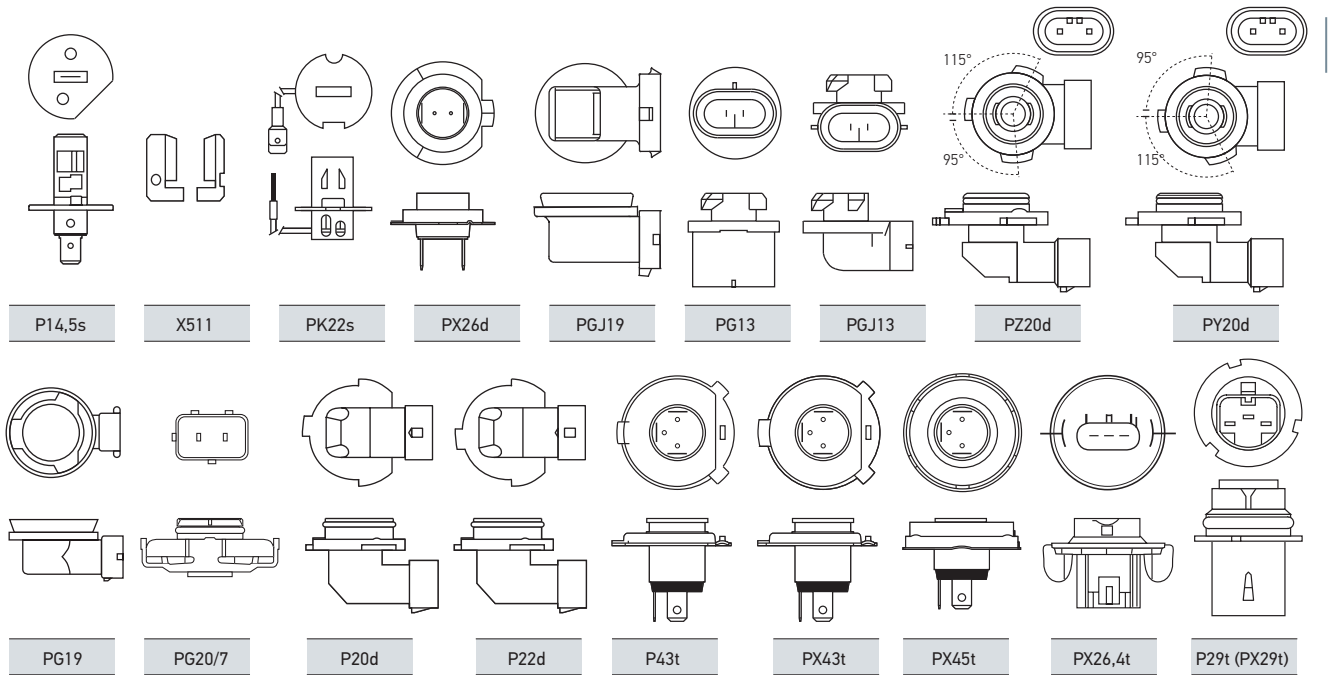
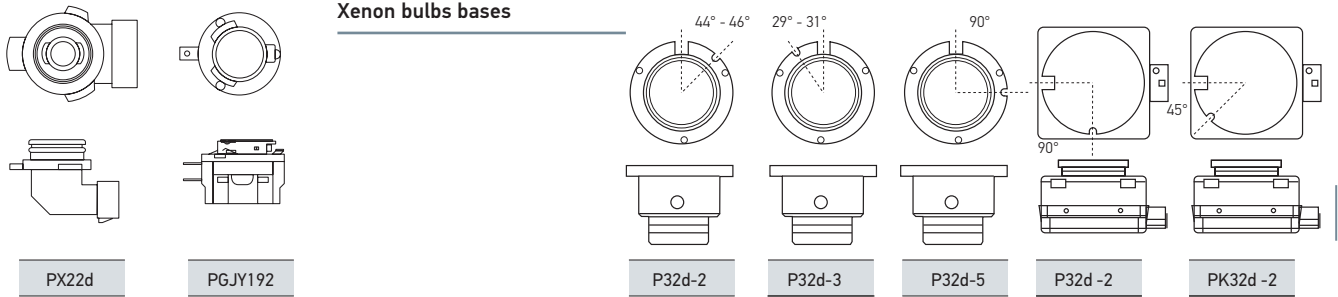
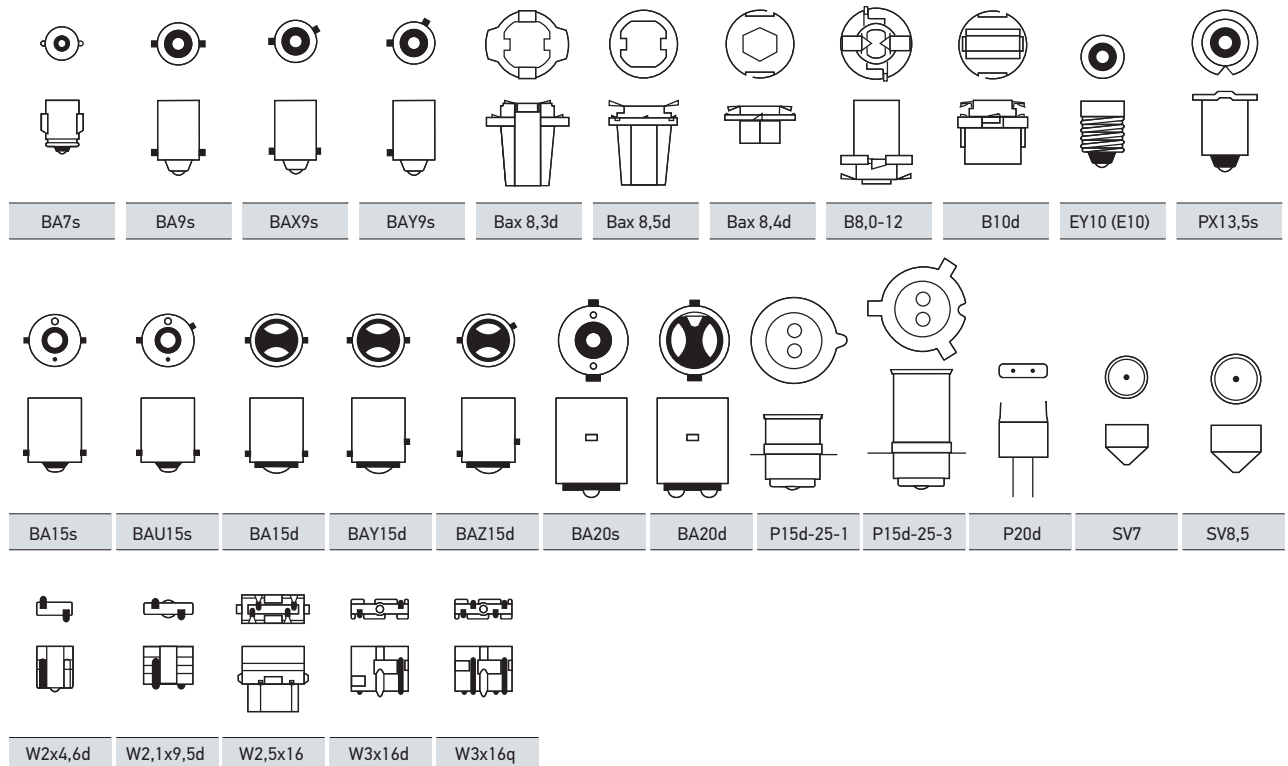
Halogen bulbs bases

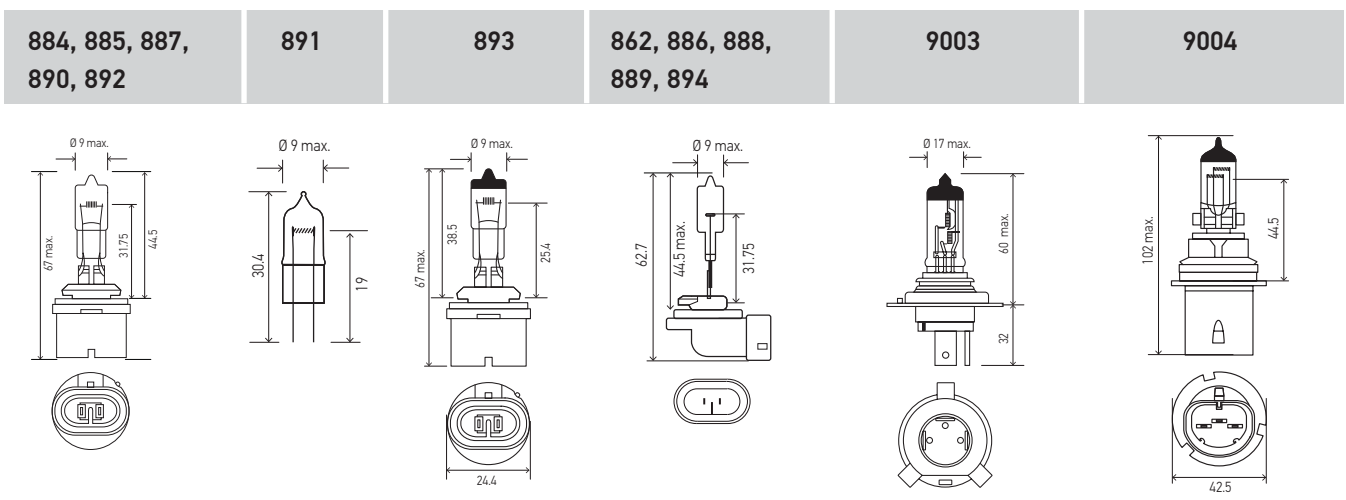
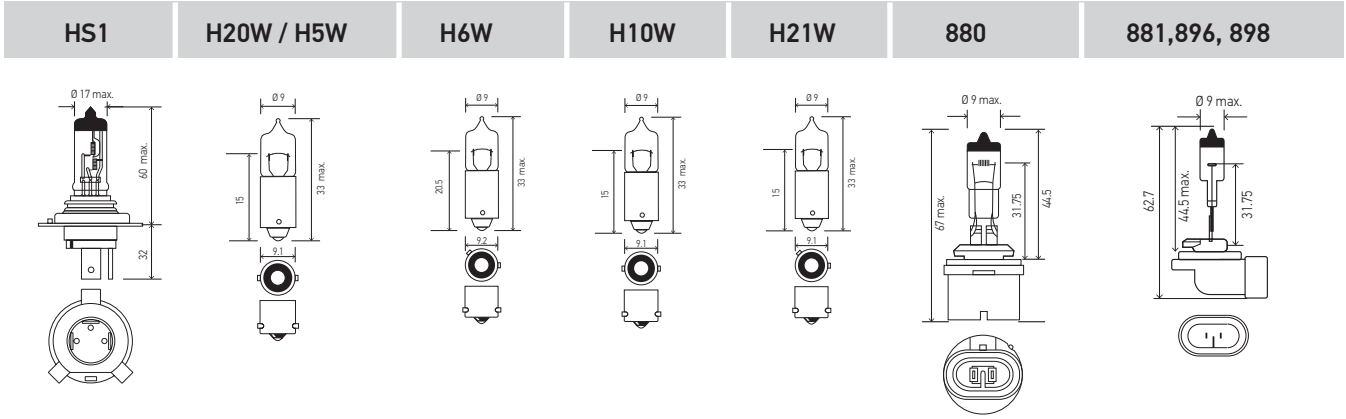
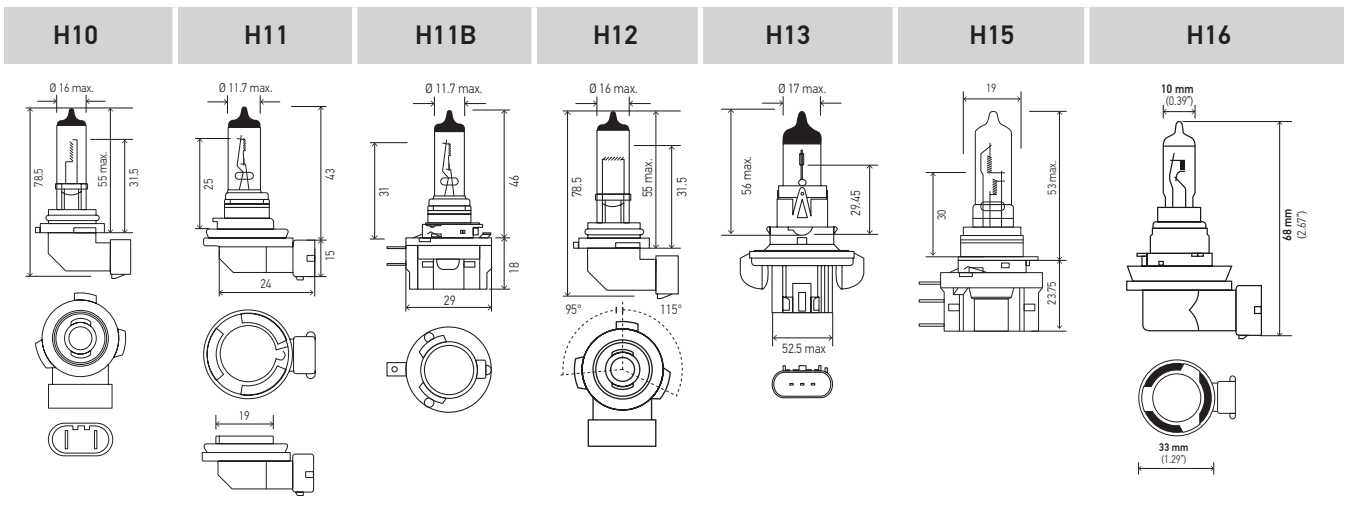
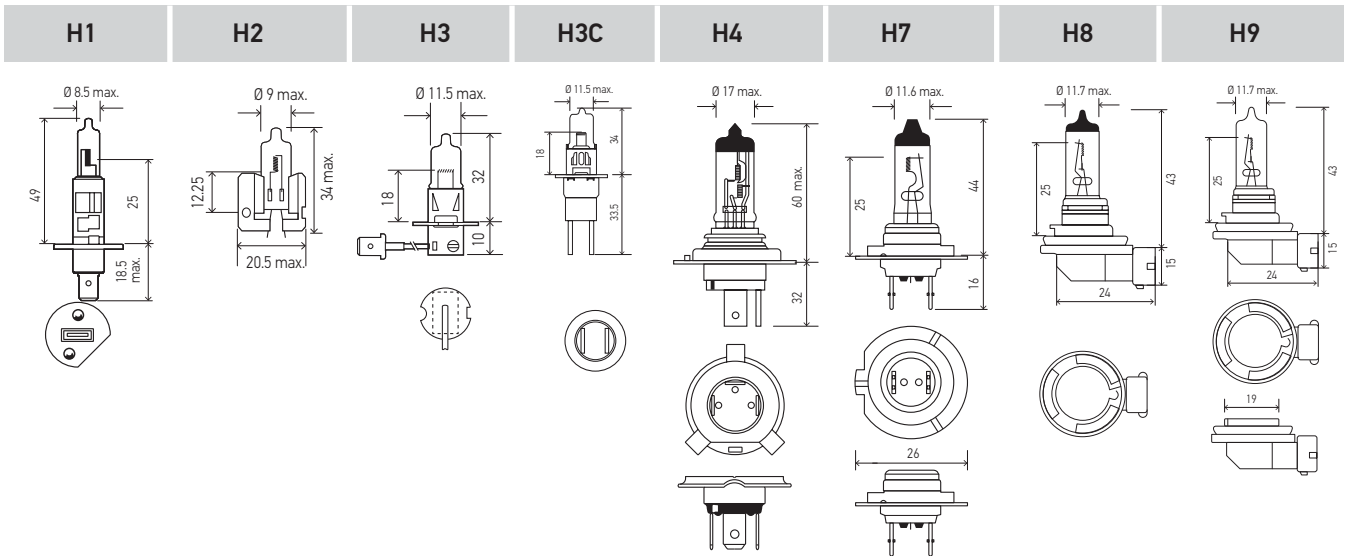
Xenon bulbs bases

Miniature bulbs bases



9005	9005XS	9006	9006XS	9007	HIR2 / 9012	9009S

M5	BA15d	BA15d	BA15d	BA15s	BA15s	BA15s	BA15s

BA15s P21W / PY21W	BA20d S2	BA20s	BA7s	BA9s	BA9s	BA9s	BA9s

BAU15s P21W/PY21W	BAY15d	BAY15d	BAY15d	BAZ15d	G4	P45t / R2



PX15d	SV7-8	SV7-8	SV8.5-8	SV8.5-8	SV8.5-8 / C5W	W2.1x4.9d
-------	-------	-------	---------	---------	---------------	-----------

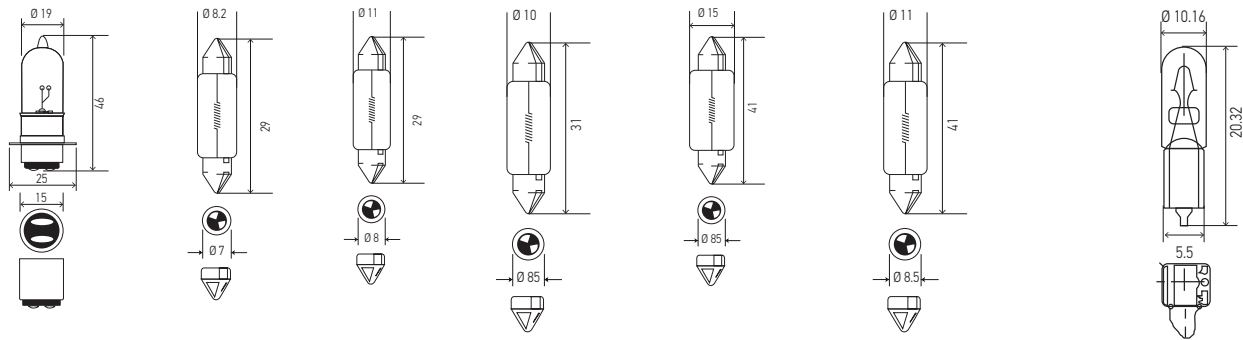

W2.1x9.5d	W2.1x9.5d	W2.1x9.5d	W2.5x16d	W2x4.6d	W2x4.6d	W2x4.6d
-----------	-----------	-----------	----------	---------	---------	---------

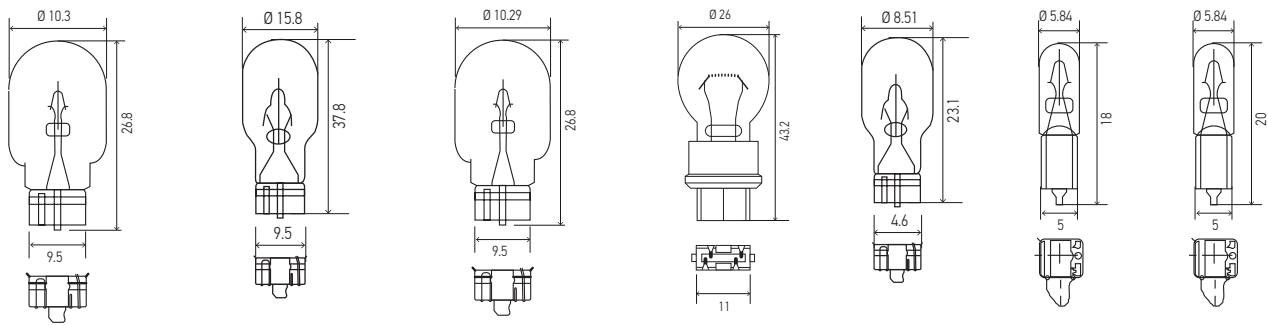

W3x16d	W3x16d	W2.5x16q	B10d	B8.3d	B8.5d	B8.5d
--------	--------	----------	------	-------	-------	-------

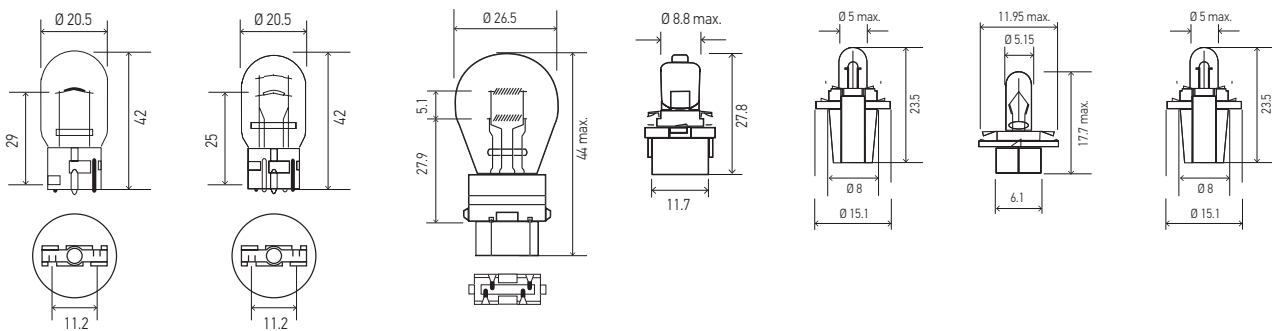

BX8.4d	EBS R4	W2x4.6d	6411 LED	6418 LED	921 LED
--------	--------	---------	----------	----------	---------

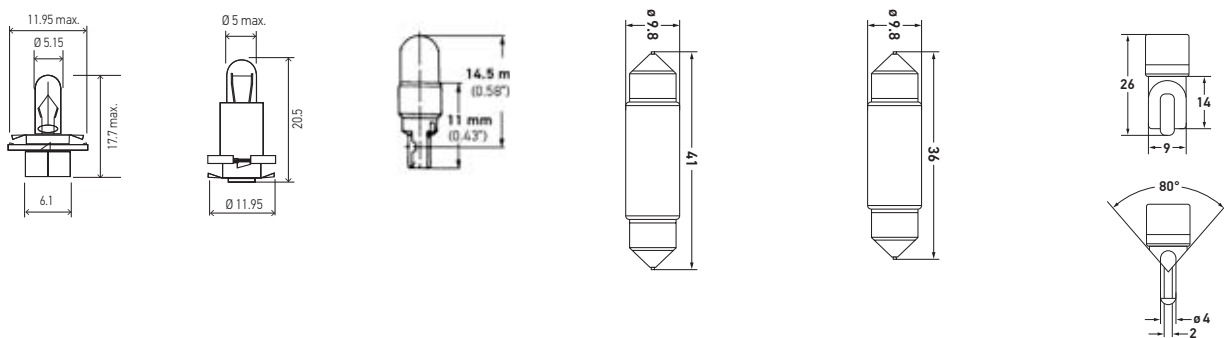

D1S	D2R	D2S	D3S	D4S
-----	-----	-----	-----	-----

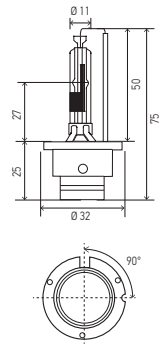
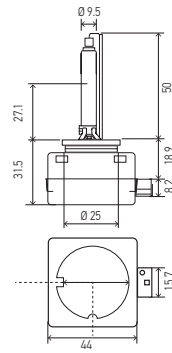
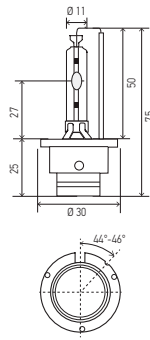
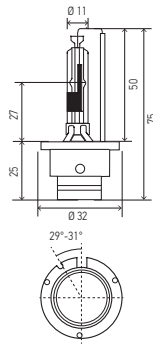
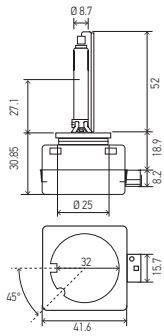



**YOUR EXPERT
FOR VISIBILITY**

HELLA – WIPER BUSINESS. SIMPLIFIED



BEST IN CLASS
MORE THAN 120 YEARS OF
GERMAN INNOVATION



**QUALITY WITHOUT
COMPROMISE**
CONSISTENTLY TESTED

APPLICATIONS
FIND APPLICATIONS CHART
AND INSTALLATION VIDEOS



HELLA
RECOGNIZED BRAND



**SATISFIED
CUSTOMERS**
MILLIONS OF BLADES
SOLD EVERY YEAR



www.hella.com/wiperblades

SATISFY THE CUSTOMERS NEEDS

DISTRIBUTOR



INSIGHTS

- Many over distributed brands
- Too much stock / too many PN 's
- More cars with more connections
- Staying profitable is a challenge

MECHANIC



- Quick selection and easy-fit
- Latest coverage
- Easy to sell to end-users
- Competitive pricing

RETAIL



NEEDS

- Easy to buy → easy to sell
- Small ranges / maximum coverage
- More profit
- Latest connections & applications

- Find right PN fast → fit fast
 - Silent and long lasting
 - Cool design
 - Pricing
- Easy to handle
 - Lasting performance
 - Trusted brand
 - OE design (upgrade)
 - Right price



HELLA WIPER BLADES PROGRAM

NEW AND SIMPLIFIED

MUST HAVE



METAL WIPER

High coverage
Value for money



CLEANTECH 2.0

Flat-Blade Technology
Multi-clips = High coverage



ADDED VALUE



REARS PLASTIC/FLAT

High coverage
Multi-clips



EXTENDED COVERAGE



HYBRID

Specific technology



WINTER

Specific technology for harsh winters



HEAVY DUTY

Built tough for professionals

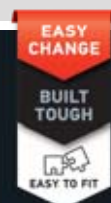

TRUCKS



METAL WIPER (STANDARD)

FULL COVERAGE – RIGHT PRICE – VALUE FOR MONEY

METAL WIPERS BLISTER PACK

You can always rely on metal wiper blades from HELLA. The blades' rubber lips are coated with graphite so that they can be constantly exposed to the most intense stresses. In addition, the design

minimises annoying wind noise. This means smooth and quiet operation with longer lasting performance, which in return improves safety and driving comfort.

PROPERTIES

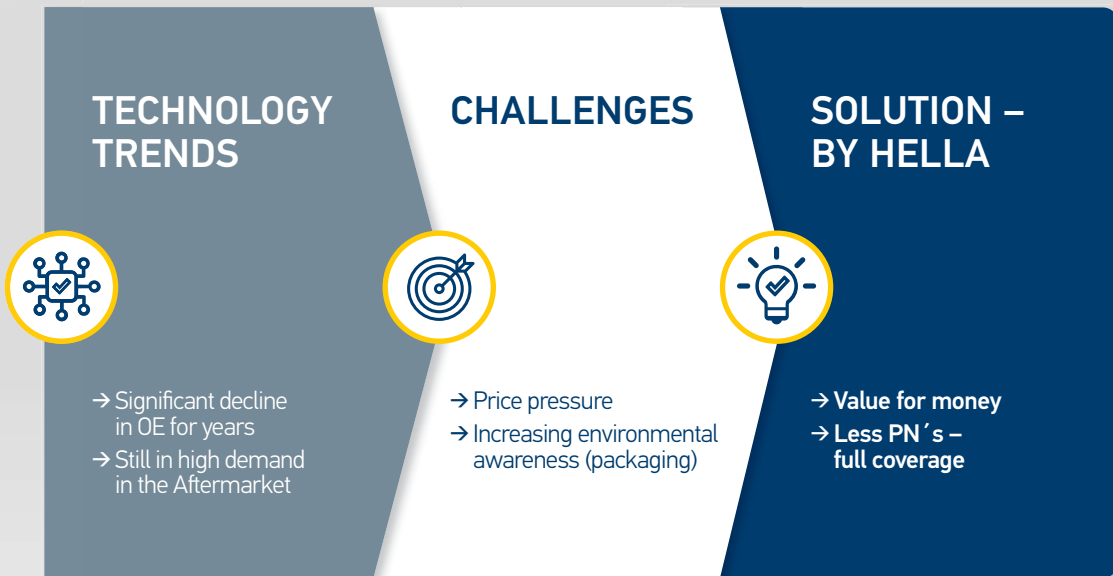

BENEFITS

- EASY CHANGE**
- EASY TO FIT**
- STREAK-FREE RUBBER**
- STREAK-FREE SILENT**
- ALL-WEATHER SAFETY**

ADAPTERS & HOOK-TYPES



SHORT CODES

SHORT CODE	CATALOG P/N	HELLA P/N	LENGTH	ADAPTERS
S11P	9XW398114011	858083111	11"	E3, B, E, V9
S13	9XW398114013	858083131	13"	E3, B, A2-1
S14	9XW398114014	858083141	14"	E3, B, V9
S14P	9XW398114014/14	858083831	14/14"	E3, B, V9
S15	9XW398114015	858083151	15"	E3, B, V9
S16P	9XW398114016	858083801	16"	E3, B, V9
S16	9XW398114016/I	858083161	16"	E3, B, V9
S18P	9XW398114018	858083811	18"	E3, B, V9
S18	9XW398114018/I	858083181	18"	E3, B, V9
S19	9XW398114019	858083191	19"	E3, B, V9
S19/21P	9XW398114019/21	858083821	19/21"	E3, B, V9
S20	9XW398114020	858083201	20"	E3, V9
S20P	9XW398114020/20	858083841	20/20"	E3, V9
S21	9XW398114021	858083211	21"	E3, V9
S22	9XW398114022	858083221	22"	E3, V9
S22P	9XW398114022/22	858083851	22/22"	E3, V9
S24	9XW398114024	858083241	24"	E3, V9
S26	9XW398114026	858083261	26"	E3, V9
S28	9XW398114028	858083281	28"	E3



CLEANTECH

MORE FLEXIBILITY FOR STYLISH AERODYNAMIC FLAT BLADE DESIGN

CLEANTECH 2.0 BLISTER PACK

High tech for the windscreen: the hingeless Clean-Tech 2.0 aerodynamic wiper blades ensure superior wiping results. The aerodynamic spoiler prevents the windscreen wiper from being lifted by the airstream. The nano-coated flat bar wipers glide smoothly over

the glass with even contact pressure. The nano-coating makes the wipers long-lasting. Various adapters ensure a high level of vehicle coverage and easy installation.

PROPERTIES

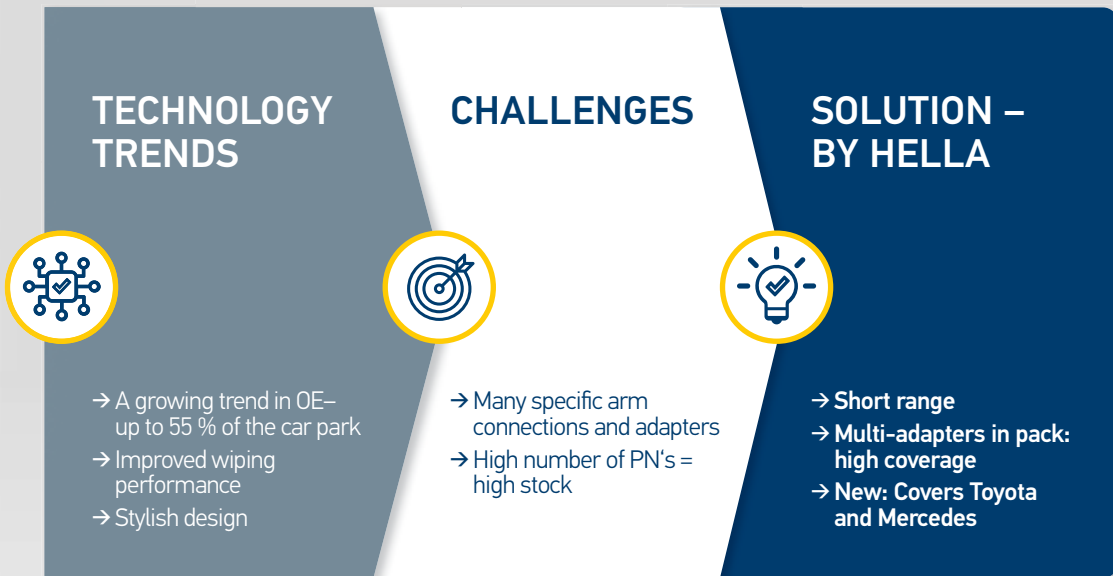

BENEFITS

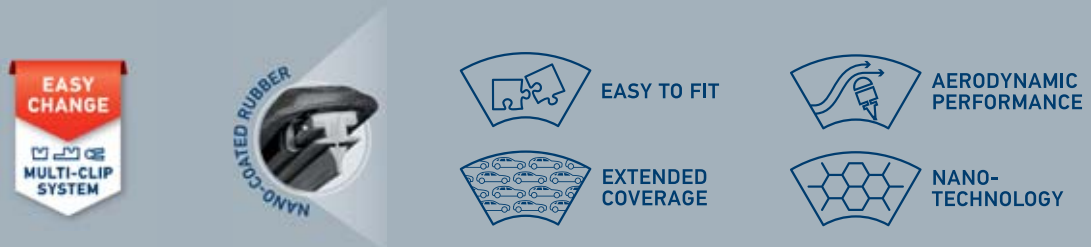

ADAPTERS & HOOK-TYPES

ADAPTERS HOOKS

3A

PINCH TAB

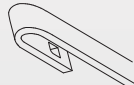
BAYONET

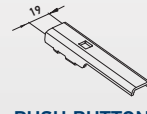
HOOK
 9 mm x 4 mm
 9 mm x 3 mm

3H-8

PUSH BUTTON
 19 mm

PUSH BUTTON
 22 mm

3B-2

SIDE LOCK
 19 mm

SIDE LOCK
 22 mm

3H-9

PUSH BUTTON
 15.5 mm

3C-B

AUDI & OLD
 Mercedes Type

RENAULT
 Scenic Type

3T

PUSH BUTTON
 FZ

3F

MULTI HOOK

INSERT LOCK
3U

LIFT & SLIDE

SHORT CODES

SHORT CODE	CATALOG & HELLA P/N	LENGTH	ADAPTERS
CT14	358054141	14"	3A, 3F, 3H-8, 3T
CT15	358054151	15"	3A, 3H-8
CT16	358054161	16"	3A, 3B-2, 3F, 3H-8, 3T
CT17	358054171	17"	3A, 3B-2, 3F, 3H-8, 3H-9
CT18	358054181	18"	3A, 3B-2, 3F, 3H-8, 3T, 3U, 3H-9
CT19	358054191	19"	3A, 3B-2, 3F, 3H-8, 3U, 3H-9
CT20	358054201	20"	3A, 3B-2, 3F, 3H-8, 3T
CT21	358054211	21"	3A, 3B-2, 3F, 3H-8, 3H-9
CT22	358054221	22"	3A, 3B-2, 3C, 3F, 3H-8, 3U, 3T, 3H-9
CT23	358054231	23"	3A, 3B-2, 3F, 3H-8
CT24	358054241	24"	3A, 3B-2, 3C, 3F, 3H-8, 3T, 3U, 3H-9
CT26	358054261	26"	3A, 3B-2, 3F, 3H-8, 3T, 3U
CT28	358054281	28"	3A, 3B-2, 3H-8, 3T, 3U
CT30	358054301	30"	3A, 3B-2, 3F, 3H-8, 3T
CT32	358054321	32"	3B-2, 3F, 3H-8



REAR PLASTIC

MORE FLEXIBILITY FOR REAR-SPECIFIC OE-LIKE DESIGN

REAR PLASTIC BLISTER PACK

For optimum visibility out of the rear window: HELLA Rear-Flat Plastic Wiper Blades are the ideal solution for numerous vehicles and cover up to 20 % of the vehicle fleet. The special nano-coating not only ensures an optimal, streak-free wiping result, even under adverse conditions, but also guarantees a very long service life. The specially developed, lightweight material

is exceptionally robust and resistant. The modern aerodynamic flat bar design is inspired by original wipers. Thanks to the innovative multi-adapter system, the wipers can be used universally on many vehicles and, thanks to Easy-Fit, can be fitted in just a few simple steps.



PROPERTIES

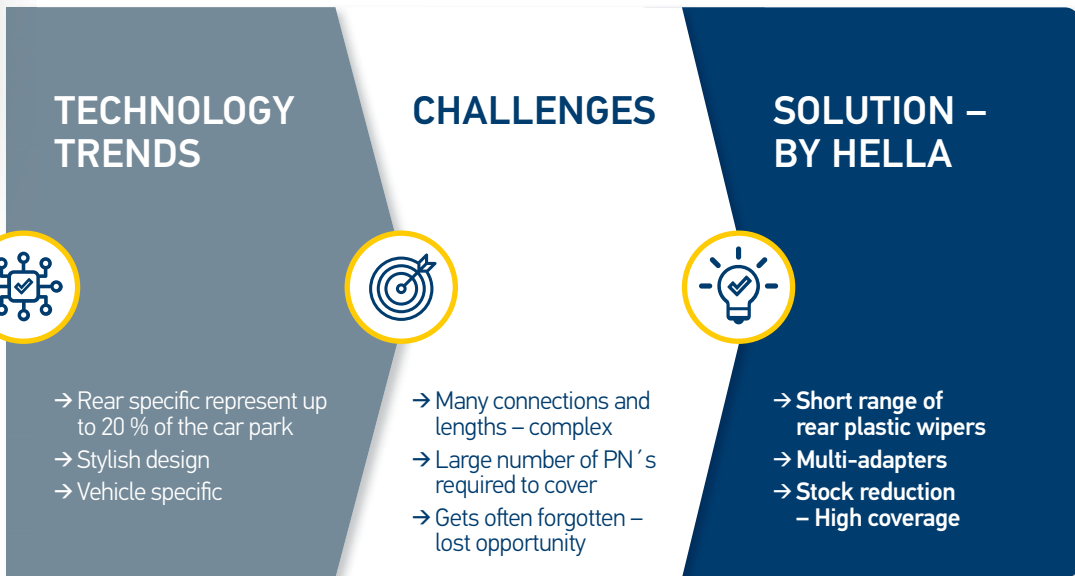

BENEFITS

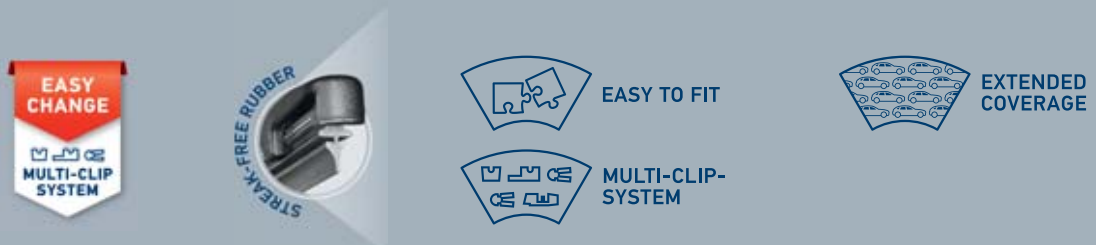

ADAPTERS & HOOK-TYPES

ADAPTERS

HOOKS

5A

ROCK LOCK 2

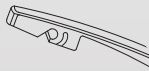
5B

ROCK LOCK 3

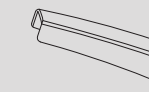
5C

SLIDE PINCH

ADAPTERS

HOOKS

5D

SNAP CLAW L

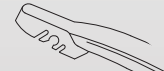
5E

SNAP CLAW H

REAR PLASTIC

SHORT CODE	CATALOG P/N	HELLA PN	LENGTH	ADAPTERS	APPLICATIONS
RP10	9XW358182101	358182101	10"	5A, 5B	Jeep Compass, Toyota Highlander, Honda HR-V
RP11	9XW398114011T	358112911	11"	5A, 5B	Nissan Rogue, Jeep Grand Cherokee, Kia Soul
RP12	9XW398114012T	358112921	12"	5A, 5B, 5E	Toyota RAV4, Honda CR-V, Ford Escape
RP14	9XW398114014T	358112931	14"	5A, 5B, 5C, 5D	Honda CR-V, Jeep Grand Cherokee, Mazda CX-5
RP16	9XW398114016T	358112941	16"	5A, 5B, 5E	Toyota Prius, Honda Odyssey, Dodge Grand Caravan

REAR OE

SHORT CODE	CATALOG P/N	HELLA PN	LENGTH	APPLICATIONS
ROE10	9XW398115010T	358112951	10"	Chevrolet Traverse, Ford Escape, Jeep Liberty, Kia Soul
ROE12	9XW398115012T	358112961	11"	BMW X5, Mazda CX-3, Nissan Kicks
ROE13	9XW398115013T	358112971	12"	Chrysler Pacifica, Ford Crown Victoria, Nissan Pathfinder
ROE14	9XW398115014T	358112981	14"	Chevrolet Blazer, Nissan Versa
ROE15	9XW398115015T	358114151	15"	BMW X5
ROE16	9XW398115016T	358112991	16"	Chevrolet Equinox, Ford Explorer





REAR FLAT

MORE FLEXIBILITY FOR REAR SPECIFIC OE-LIKE FLAT DESIGN

REAR FLAT BLISTER PACK

State-of-the-art technology for the rear window: thanks to their nano-coating, the HELLA Rear Flat Wiper Blades ensure outstanding wiping results in rain, snow and spray water, and all that with extremely low wear. The extremely flat, aerodynamic wiper blades are based on the design of modern

original equipment wipers, so they cut a fine figure at the rear of any vehicle. Thanks to the Easychange system with modular adapters, the wipers can be mounted in just a few simple steps and used on numerous different vehicles.

PROPERTIES

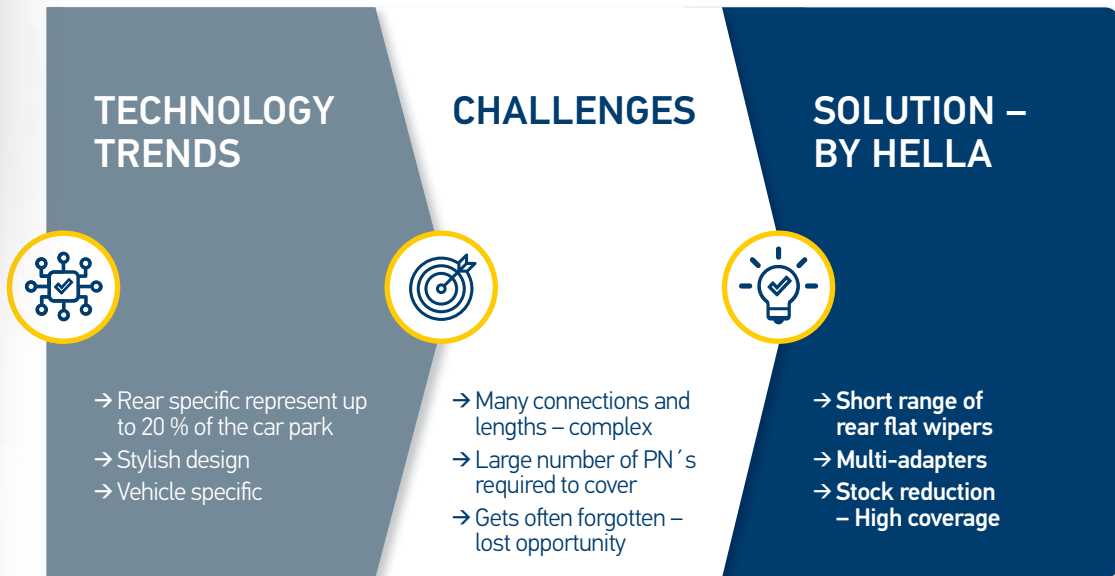

BENEFITS

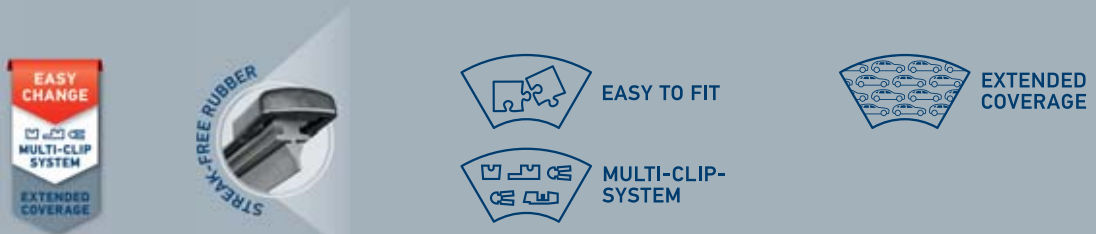

ADAPTERS & HOOK-TYPES

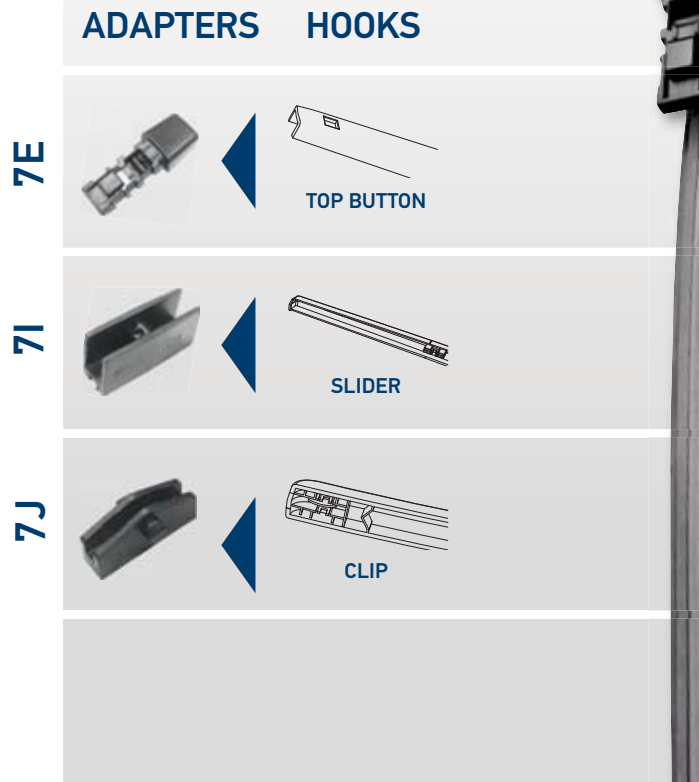

SHORT CODES

SHORT CODE	CATALOG P/N	HELLA P/N	LENGTH	ADAPTERS	APPLICATIONS
RF10	9XW358179101	358179101	10"	7A, 7C, 7E	Lincoln Corsair, Mini Cooper Countryman
RF11	9XW358179111	358179111	11"	7A, 7C, 7D, 7E	Ford Escape, VW Atlas, BMW X3
RF13	9XW358179131	358179131	13"	7A, 7C, 7D, 7E, 7J	MB GLC300, BMW X3, VW Tiguan
RF14	9XW358179141	358179141	14"	7A, 7B, 7I	Volvo V90, Volvo XC40, Volvo XC60
RF15	9XW358179151	358179151	15"	7A, 7C, 7D, 7J	VW Touareg, Volvo XC60
RF16	9XW358179161	358179161	16"	7A, 7D, 7E, 7J	Ford Expedition, Audi Q7, BMW X7
RF17	9XW358179171	358179171	17"	7A, 7C	Land Rover Range Rover
RF18	9XW358179181	358179181	18"	7A, 7D	-



HYBRID

MORE FLEXIBILITY FOR STYLISH OE-LIKE ALL-WEATHER DESIGN

HYBRID CARTON

Hybrid technology integrates the best design features of a conventional frame with a flat blade design giving enhanced wiping performance and therefore increasing driving safety in all weathers. Fast and easy exchange

of old wiper blades thanks to the Easy-Fit system adaptors – very popular on Asian vehicle brands

PROPERTIES

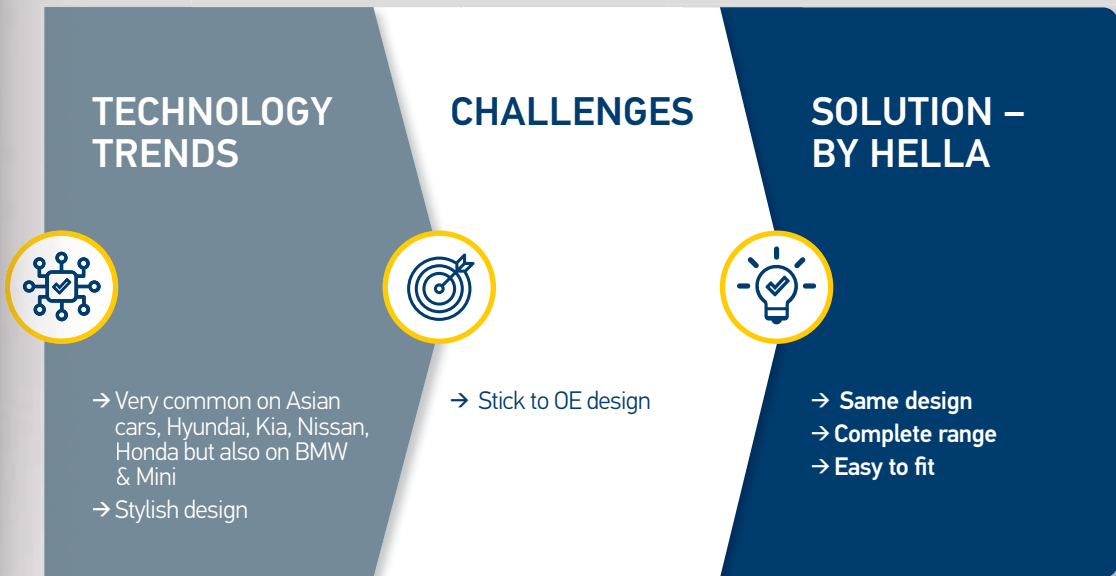

BENEFITS

-  **EASY CHANGE**
-  **ORIGINAL DESIGN**
-  **ANTI-CLINGING TECHNOLOGY**
-  **STREAK-FREE RUBBER**
-  **ALL-WEATHER SAFETY**
-  **LASTING PERFORMANCE**
-  **OE-LIKE DESIGN**

ADAPTERS & HOOK-TYPES

ADAPTERS

HOOKS

V11

HOOK
9 mm x 3 mm

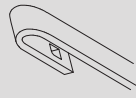
T10+

HOOK
9 mm x 3 mm

SHORT CODES

SHORT CODE	HELLA P/N	LENGTH	ADAPTERS
H35	204584141	14"	V11, T10
H40	204584161	16"	V11, T10
H43	204584171	17"	V11, T10
H45	204584181	18"	V11, T10
H48	204584191	19"	V11, T10
H50	204584201	20"	V11, T10
H53	204584211	21"	V11, T10
H55	204584221	22"	V11, T10
H60	204584241	24"	V11, T10
H65	204584261	26"	V11, T10
H70	204584281	28"	V11, T10





WINTER

MORE FLEXIBILITY WITH WINTER CONDITIONS PERFORMANCE

WINTER CARTON

The extremely resistant HELLA Winter Wiper Blades are optimised for adverse conditions, such as snow, sleet and road salt, and always ensure a perfect view, even in winter. The wiper lips' special rubber compound is particularly resistant and offers a streak-free wiping experience even in sleet. The robust wiper construction, based on the design of

original wipers, guarantees long durability and perfect function at all times. The easy-to-fit HELLA Winter Wiper Blades are available for various vehicle types.

PROPERTIES

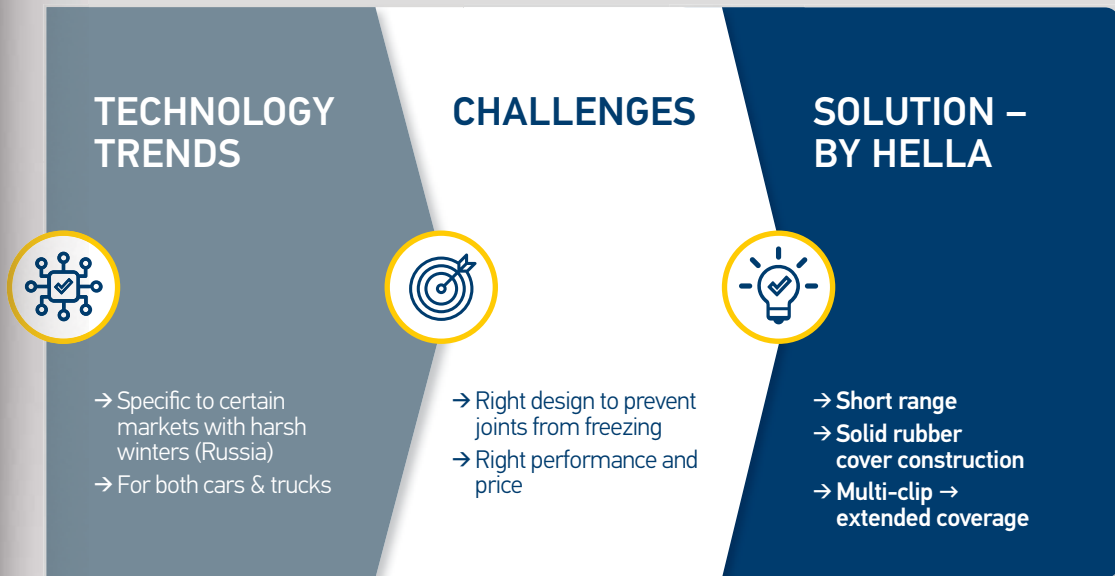

BENEFITS



ADAPTERS & HOOK-TYPES

ADAPTERS HOOKS

3A

PINCH TAB **BAYONET** **HOOK**
 9 mm x 3 mm
 9 mm x 4 mm

3B-2

SIDE LOCK **SIDE LOCK**
 19 mm 22 mm

3C-B

AUDI & OLD **RENAULT**
 Mercedes Type Scenic Type

ADAPTERS HOOKS

3H-8

PUSH BUTTON **PUSH BUTTON**
 19 mm 22 mm

3F

MULTI HOOK **INSERT LOCK**

SHORT CODES

SHORT CODE	CATALOG P/N	HELLA P/N	LENGTH	ADAPTERS
W35	9XW358004141	358004141	14"	3A, 3B-2, 3H-8, 3C, 3F
W40	9XW358004161	358004161	16"	3A, 3B-2, 3H-8, 3C, 3F
W45	9XW358004181	358004181	18"	3A, 3B-2, 3H-8, 3C, 3F
W48	9XW358004191	358004191	19"	3A, 3B-2, 3H-8, 3C, 3F
W50	9XW358004201	358004201	20"	3A, 3B-2, 3H-8, 3C, 3F
W53	9XW358004211	358004211	21"	3A, 3B-2, 3H-8, 3C, 3F
W55	9XW358004221	358004221	22"	3A, 3B-2, 3H-8, 3C, 3F
W60	9XW358004241	358004241	24"	3A, 3B-2, 3H-8, 3C, 3F
W65	9XW358004261	358004261	26"	3A, 3B-2, 3H-8, 3C, 3F





HEAVY DUTY

MORE FLEXIBILITY FOR LASTING PERFORMANCE

HEAVY DUTY CARTON

HELLA Heavy Duty Wipers defy even the most adverse conditions and heavy loads when used continuously every day on the road or in agriculture, and they reliably ensure a clear view in every situation. Nothing can shake the wipers that easily, thanks to the sturdy, high-quality steel frame. The reinforced

heavy-duty rubber compound ensures long durability and optimum wiping results even in harsher environmental conditions, important attributes for agricultural vehicles in particular. Also available with an integrated spray nozzle for an even better wiping experience.



PROPERTIES



BENEFITS



LASTING PERFORMANCE



HIGH QUALITY STEEL FRAME

ADAPTERS & HOOK-TYPES

E3		 HOOK 9 mm x 3 mm	 HOOK 9 mm x 4 mm	 BAYONET 7 mm x 2.6 mm	 PIN 4.8 mm x 6.3 mm	
	ADAPTERS	HOOKS	ADAPTERS	HOOKS	ADAPTERS	
F1		 HOOK 9 mm x 4 mm	M1	 SADDLE 13.6, 17 mm	T5	 BAYONET
F5		 HOOK 12 mm x 4 mm	M3	 SADDLE 21, 24, 26, 27 mm	T8	 SADDLE With screws
F7	 SADDLE With screws	 SADDLE With screws	M8	 SADDLE 26 mm	TR4	 SADDLE 13.6 mm
F10	 HOOK	 HOOK	TR2-1	 SADDLE 7/32", 1/4"	TR9	 BAYONET 8.5 mm

SHORT CODES

SHORT CODE	CATALOG P/N	HELLA P/N	LENGTH	ADAPTERS
HD20	9XW191398201	191398201	20"	E3, B, A2-1, TR9+SCREW
HD22	9XW191398221	191398221	22"	E3, B, A2-1, F1, TR4, T5 +SCREW
HD24	9XW191398241	191398241	24"	F5, F10, T8-1+(M9) SCREW, T9
HD26	9XW191398261	191398261	26"	F5, F10, T8-1+(M9) SCREW
HD28	9XW191398281	191398281	28"	F5, F10, T8-1+(M9), G1, F9
HD32	9XW191398321	191398321	32"	M, M1+SCREW, M7+SCREW, M8+SCREW
HD36	9XW191398361	191398361	36"	M2, M3-1 +SCREW, M6+SCREW
HD40SP	9XW191398401	191398401	40"	M2, M3-1 +SCREW, M6+SCREW
HS40SH	9XW191398402	191398402	40"	F7 (HOOK)

SPECIFIC (NEW)

HDT15	9XW358178151	358178151	15"	TR2-1
HDT16	9XW358178161	358178161	16"	TR2-1
HDT18	9XW358178181	358178181	18"	TR2-1
HDT20	358178201	358178201	20"	TR2-1
HDT22	358178221	358178221	22"	TR2-1

ELECTRICAL WATER PUMPS, 12V

Part Number	Function	Voltage (V)	Design	Delivery flow g / min(l/min)	Pressure (bar)	Cap Part Number	Housing diameter inches (mm)	Inlet diameter inches(mm)	Outlet diameter inches(mm)
004223031	Headlight / windshield	12	Single	0.264 (1)	2	008151021	1.378 (35)	0.276 (7)	0.236 (6)
005496011	Headlight / windshield	12	Single	0.264 (1)	2		1.378 (35)	0.276 (7)	0.236 (6)
005206031	Windshield cleaning	12	Double	0.264 (1)	2	008151021	1.378 (35)	0.276 (7)	0.236 (6)
007540211	Windshield cleaning	12	Single	1.902 (7.2)	2.5	008151021	1.378 (35)	0.453 (11.5)	0.433 (11)
004764021	Headlight cleaning	12	Single	1.902 (7.2)	2.5	008151021	1.378/1.811 (35/46)	0.413 (10.5)	0.433 (11)



ELECTRICAL WATER PUMPS, 24V

Part Number	Function	Voltage (V)	Design	Delivery flow g / min(l/min)	Pressure (bar)	Cap Part Number	Housing diameter inches (mm)	Inlet diameter inches (mm)	Outlet diameter inches(mm)
004764041	Headlight / windshield	24	Single	1.902 (7.2)	2.5	008151021	1.378/1.811 (35/46)	0.413 (10.5)	0.433 (11)
005496051	Windshield cleaning	24	Single	0.264 (1)	2	008151021	1.378 (35)	0.276 (7)	0.236 (6)
007540231	Windshield cleaning	24	Single	1.902 (7.2)	2.5	008151021	1.378 (35)	0.413 (10.5)	0.433 (11)



HEADLIGHT CLEANING SYSTEMS

Part Number	Function	Voltage (V)	Spare part: Pump
008549001	Headlight cleaning system with fixed nozzles	12V	007540211
008549501	Headlight cleaning system with fixed nozzles	24V	007540231

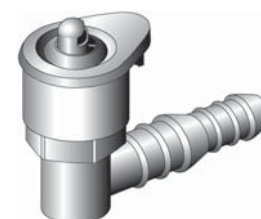

RELAY

Part Number	Function	Voltage (V)	Number of polos	Temperature range °F (°C)	Notes
003620091	Cleaning / Washing Interval	12V	6	-22/185° (-30/+85°)	Without holder

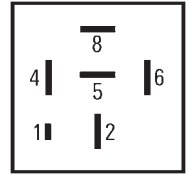

YOUR SAFETY IS OUR PRIORITY



MICROSITE: Find out about
HELLA Electrics range



www.hellahd.com

Quality is extremely important in electric HELLA products such as relays, speakers, switches, flashing lights, electric vacuum pumps, plugs, sockets and much more, due to their high precision and reliability. HELLA products not only comply with the strict legal regulatory requirements but also with the much more demanding requirements made by vehicle manufacturers and the aftermarket.



RELAYERS, FLASHERS, FUSES AND CONTROL DEVICES

Our relays, flashers and controllers are designed to do their job reliably for a long time. And because perfection and durability is one of our strengths to the smallest detail, HELLA offers the most reliable products and one of the widest ranges in this sector: mini-relays, high performance relays, micro relays, relays battery disconnection and solid state relays, for cars, commercial vehicles and trucks; flashers with the classification of a single circuit, flashers of two and three circuits for trucks, vans, commercial vehicles, agricultural and construction machines, time control units and LED light, as well as light switch modules..



ACOUSTIC SIGNAL UNITS

A security product that does not require many words: horns, bugles and trumpets. Whether you choose the harmonic sound of the two-tone electric disc horn or the penetrating sound of our supertone bugles, your customers will surely be able to be noticed.

The trumpets of pressurized air; Our warning signs are always at the forefront. We have been integrating reliability and precision for over 100 years. At HELLA, security simply has tradition.

HORNS APP - Online tool to compare the different acoustic signal units



www.hella.com/apps



EXPLORE THE POSSIBILITIES PRODUCT RANGE

ESSENTIAL HORNS

HEAVY DUTY HORNS

STYLE HORNS

COMPRESSED AIR HORNS

PERFORMANCE HORNS

BACK-UP ALARMS

OE-CONNECT HORNS

MOTORCYCLE HORNS

ENJOY YOUR
URBAN JUNGLE
HEAR THE ROAR



LOUD

HARMONIC



BLASTER

PRODUCT OVERVIEW

Short code	Part no.	Quantity								
Cars										
TE40 Set	007728981	1 set (2 pcs)	400 / 500 Hz	112 ± 3 dB (A)	2 x 48 W	12 V	≤ 4.0 A	IP 65	ECE-R28	500,000x
TE20 Set	011225831	1 set (2 pcs)	400 / 500 Hz	110 ± 3 dB (A)	2 x 72 W	12 V	≤ 6.0 A	IP 65	ECE-R28	100,000x
TE20 Set, Blister	012010971	1 set (2 pcs)	400 / 500 Hz	110 ± 3 dB (A)	2 x 72 W	12 V	≤ 6.0 A	IP 65	ECE-R28	100,000x
S77 Set, Classic	012588151	1 set (2 pcs)	360 / 430 Hz	110 ± 3 dB (A)	2 x 48 W	12 V	≤ 4.0 A	IP 65	ECE-R28	80,000x
S77, Classic	012588351	1 piece	430 Hz	110 ± 3 dB (A)	48 W	12 V	≤ 4.0 A	IP 65	ECE-R28	80,000x
S92 Set	011225871	1 set (2 pcs)	335 / 435 Hz	113 ± 3 dB (A)	2 x 60 W	12 V	≤ 5.0 A	IP 65	ECE-R28	100,000x
S92 Set, Blister	012588071	1 set (2 pcs)	435 Hz	113 ± 3 dB (A)	2 x 60 W	12 V	≤ 5.0 A	IP 65	ECE-R28	100,000x
	012588141	1 set (2 pcs)	335 Hz	113 ± 3 dB (A)	2 x 60 W	12 V	≤ 5.0 A	IP 65	ECE-R28	100,000x
TE24 Set Red, includes 4-pin relay	007424801	1 set (2 pcs)	400 / 500 Hz	110 ± 3 dB (A)	2 x 72 W	12 V	≤ 6.0 A	IP 65	ECE-R28	100,000x
TE24 Set Blue	012010801	1 set (2 pcs)	400 / 500 Hz	110 ± 3 dB (A)	2 x 72 W	12 V	≤ 6.0 A	IP 65	ECE-R28	100,000x
TE24 Set Yellow	012010821	1 set (2 pcs)	400 / 500 Hz	110 ± 3 dB (A)	2 x 72 W	12 V	≤ 6.0 A	IP 65	ECE-R28	100,000x
TE24 Red	007424001	1 piece	400 Hz	110 ± 3 dB (A)	72 W	12 V	≤ 6.0 A	IP 65	ECE-R28	100,000x
TE24 Red	007424011	1 piece	500 Hz	110 ± 3 dB (A)	72 W	12 V	≤ 6.0 A	IP 65	ECE-R28	100,000x
S108 Set	922000731	1 set (2 pcs)	350 / 415 Hz	115 ± 3 dB (A)	2 x 42 W	12 V	≤ 3.5 A	IP 65	ECE-R28	100,000x
S98 Set	012588341	1 set (2 pcs)	335 / 400 Hz	115 ± 3 dB (A)	2 x 54 W	12 V	≤ 4.5 A	IP 65	ECE-R28	80,000x
S98	012588291	1 piece	400 Hz	115 ± 3 dB (A)	54 W	12 V	≤ 4.5 A	IP 65	ECE-R28	80,000x
TE30 Set, chrome	007728883	1 set (2 pcs)	410 / 510 Hz	112 ± 3 dB (A)	2 x 60 W	12 V	≤ 5.0 A	IP 54	ECE-R28	100,000x
TE30 Set, gold	007728893	1 set (2 pcs)	410 / 510 Hz	112 ± 3 dB (A)	2 x 60 W	12 V	≤ 5.0 A	IP 54	ECE-R28	100,000x
S130 Set	004811091	1 set (2 pcs)	280 / 380 Hz	118 ± 3 dB (A)	2 x 60 W	12 V	≤ 5.0 A	IP 54	ECE-R28	100,000x
S140 Set	004811101	1 set (2 pcs)	280 / 380 Hz	118 dB (A)	2 x 60 W	12 V	≤ 5.0 A	IP 54	ECE-R28	100,000x
S140 Set, 24 V	004811081	1 set (2 pcs)	280 / 380 Hz	118 dB (A)	2 x 60 W	24 V	≤ 5.0 A	IP 54	ECE-R28	100,000x
B133 Set, includes 4-pin relay	003399801	1 set (2 pcs)	300 / 500 Hz	118 ± 3 dB (A)	2 x 66 W	12 V	≤ 5.5 A	IP 65	ECE-R28	100,000x
B133	358114051	1 piece	500 Hz	118 ± 3 dB (A)	66 W	12 V	≤ 5.5 A	IP 65	ECE-R28	100,000x
S77 Set										
For TOYOTA	011225881	1 set (2 pcs)	350 / 420 Hz	111 ± 3 dB (A)	2 x 48 W	12 V	≤ 4.0 A	IP 65	ECE-R28	100,000x
For HONDA	011225891	1 set (2 pcs)	350 / 420 Hz	111 ± 3 dB (A)	2 x 48 W	12 V	≤ 4.0 A	IP 65	ECE-R28	100,000x
TE26 Set										
For AUDI, SEAT, VW	011225841	1 set (2 pcs)	400 / 500 Hz	110 ± 3 dB (A)	2 x 72 W	12 V	≤ 6.0 A	IP 65	ECE-R28	100,000x
For BMW	012010881	1 set (2 pcs)	400 / 500 Hz	110 ± 3 dB (A)	2 x 72 W	12 V	≤ 6.0 A	IP 65	ECE-R28	100,000x
For FORD	011225921	1 set (2 pcs)	400 / 500 Hz	110 ± 3 dB (A)	2 x 72 W	12 V	≤ 6.0 A	IP 65	ECE-R28	100,000x
For HONDA	012010911	1 set (2 pcs)	400 / 500 Hz	110 ± 3 dB (A)	2 x 72 W	12 V	≤ 6.0 A	IP 65	ECE-R28	100,000x
For HYUNDAI	011225901	1 set (2 pcs)	400 / 500 Hz	110 ± 3 dB (A)	2 x 72 W	12 V	≤ 6.0 A	IP 65	ECE-R28	100,000x
For PEUGEOT	012010891	1 set (2 pcs)	400 / 500 Hz	110 ± 3 dB (A)	2 x 72 W	12 V	≤ 6.0 A	IP 65	ECE-R28	100,000x
For TOYOTA	012010901	1 set (2 pcs)	400 / 500 Hz	110 ± 3 dB (A)	2 x 72 W	12 V	≤ 6.0 A	IP 65	ECE-R28	100,000x
For VW	011225851	1 set (2 pcs)	400 / 500 Hz	110 ± 3 dB (A)	2 x 72 W	12 V	≤ 6.0 A	IP 65	ECE-R28	100,000x

eLONG-LIFE HORNS

PERFORMANCE HORNS

COMPRESSED AIR HORNS

ESSENTIAL HORNS

OE-CONNECT HORNS

BACK-UP ALARMS

STYLE HORNS

HEAVY DUTY HORNS

MOTORCYCLE HORNS

Short code	Part no.	Quantity								
Commercial Vehicles										
TE30 Set	940800821	1 set (2 pcs)	410 / 510 Hz	110±3 dB (A)	2x72 W	24 V	≤3.0 A	IP 65	ECE-R28	100,000x
S92 Set	002768821	1 set (2 pcs)	335 / 435 Hz	113±3 dB (A)	2x72 W	24 V	≤3.0 A	IP 65	ECE-R28	100,000x
S130 Set	004811071	1 set (2 pcs)	280 / 380 Hz	118±3 dB (A)	2x72 W	24 V	≤3.0 A	IP 54	ECE-R28	100,000x
B133 Set	003399101	1 set (2 pcs)	375 / 500 Hz	118 dB (A)	2x84 W	24 V	≤3.5 A	IP 65	ECE-R28	100,000x
B133	003399061	1 piece	375 Hz	118 dB (A)	84 W	24 V	≤3.5 A	IP 65	ECE-R28	100,000x
	003399071	1 piece	500 Hz	118 dB (A)	84 W	24 V	≤3.5 A	IP 65	ECE-R28	100,000x
DL50 Set	004811042	1 set (2 pcs)	310 / 380 Hz	114±3 dB (A)	2x72 W	12 V	≤3.5 A	IP 54	ECE-R28	100,000x
DL50	004811001	1 piece	310 Hz	114±3 dB (A)	72 W	12 V	≤3.5 A	IP 54	ECE-R28	100,000x
	004811011	1 piece	380 Hz	114±3 dB (A)	72 W	12 V	≤3.5 A	IP 54	ECE-R28	100,000x
DL50 Set	004811132	1 set (2 pcs)	310 / 380 Hz	114±3 dB (A)	2x84 W	24 V	≤6.0 A	IP 54	ECE-R28	100,000x
DL50	004811021	1 piece	310 Hz	114±3 dB (A)	84 W	24 V	≤6.0 A	IP 54	ECE-R28	100,000x
	004811031	1 piece	380 Hz	114±3 dB (A)	84 W	24 V	≤6.0 A	IP 54	ECE-R28	100,000x
B36	002768082	1 piece	335 Hz	116±2 dB (A)	72 W	12 V	≤6.0 A	IP 65	ECE-R28	100,000x
	002768551	1 piece	400 Hz	116±2 dB (A)	72 W	12 V	≤6.0 A	IP 65	ECE-R28	100,000x
	002768382	1 piece	335 Hz	116±2 dB (A)	72 W	24 V	≤6.0 A	IP 65	ECE-R28	100,000x
	002768431	1 piece	400 Hz	116±2 dB (A)	72 W	24 V	≤6.0 A	IP 65	ECE-R28	100,000x
M26	002952861	1 piece	335 Hz	115 dB (A)	66 W	12 V	≤5.5 A	IP 54	ECE-R28	100,000x
	002952811	1 piece	400 Hz	115 dB (A)	66 W	12 V	≤5.5 A	IP 54	ECE-R28	100,000x
	006958901	1 piece	335 Hz	115 dB (A)	80 W	12 V	≤5.5 A	IP 54	ECE-R28	100,000x
CA10 Set	003001651	1 set	600 / 756 Hz	≥115 dB (A)	-	12 V	-	IP 54	ECE-R28	50,000x
	003001661	1 set	600 / 756 Hz	≥115 dB (A)	-	24 V	-	IP 54	ECE-R28	50,000x
CA12 Set	003001981	1 set	780 / 820 / 880 Hz	≥115 dB (A)	-	12 V	-	IP 54	ECE-R28	50,000x
	003001671	1 set	630 / 795 / 840 Hz	≥115 dB (A)	-	24 V	-	IP 54	ECE-R28	50,000x
CA20	013410011	1 piece	400 Hz	≥118 dB (A)	-	12-24 V	-	IP 54	ECE-R28	50,000x
CA26	013410081	1 piece	600 / 756 Hz	≥120 dB (A)	-	12 V	-	IP 54	ECE-R28	80,000x
	013410091	1 piece	600 / 756 Hz	≥120 dB (A)	-	24 V	-	IP 54	ECE-R28	80,000x
CA30	013410001	1 piece	370 Hz	≥120 dB (A)	-	12 V	-	IP 54	ECE-R28	50,000x
	013410021	1 piece	370 Hz	≥120 dB (A)	-	24 V	-	IP 54	ECE-R28	50,000x
CA34	005411001	1 piece	300 / 350 Hz	≥122 dB (A)	-	12-24 V	-	IP 54	ECE-R28	80,000x
BM10	009148141	1 piece	-	110±3 dB (A)	12 W	12-48 V	≤0.6 A	IP 67	ECE-R10	300,000x
BM10, Blister	009148142	1 piece	-	110±3 dB (A)	12 W	12-48 V	≤0.6 A	IP 67	ECE-R10	300,000x
BM10, ground plate	009148161	1 piece	-	110±3 dB (A)	12 W	12-48 V	≤0.6 A	IP 67	ECE-R10	300,000x
BM10, SAE J994	009148221	1 piece	-	110±3 dB (A)	12 W	12-48 V	≤0.6 A	IP 67	ECE-R10	300,000x
BM20	009148001	1 piece	-	90 dB (A)	12 W	12-24 V	≤0.2 A	IP 67	ECE-R10	300,000x
	009148011	1 piece	-	97 dB (A)	12 W	12-24 V	≤0.4 A	IP 67	ECE-R10	300,000x
	009148021	1 piece	-	107 dB (A)	12 W	12-24 V	≤0.7 A	IP 67	ECE-R10	300,000x
BM30	996139301	1 piece	-	112±3 dB (A)	12 W	12-48 V	≤0.6 A	IP 67	ECE-R10	500,000x
Motorcycles										
S70 Set	012588011	1 set (2 pcs)	380 / 480 Hz	108±3 dB (A)	2x18 W	12 V	≤1.5 A	IP 65	-	50,000x
S70	012588061	1 piece	460 Hz	108±3 dB (A)	18 W	12 V	≤1.5 A	IP 65	-	50,000x

Frequency [Hz]

Current consumption [A]

Sound pressure level @ 2m [dB (A)]

IP rating

Power consumption [W]

Type approval

Rated voltage [V]

Service life (ECE)

Cars

Passenger Car

Offroad Car

Motorcycles

Motorcycles

Commercial Vehicles

Truck more 3.5 t

Truck up to 3.5 t

Bus

Tractor

Product image / Dimensions	Features
----------------------------	----------

S70M SERIES

MOTORCYCLE HORNS

108 ± 3 dB (A)
 (2 x) 18 W
 12 V
 ≤ 1.5 A
 IP 65
 50,000x



Recommend for motorcycle.
 Compact and lightweight
 Good price-performance ratio
 Housing and bracket in black galvanized metal.
 Level of acoustic intensity at 2 m distance: 108 dB (A).
 Energy consumption: 16 W.
 M8 screw horn bracket.
 Operating Temperature: -40° C a 90° C (-40°F a 194°F)
 Approval: ECE



2 Pieces

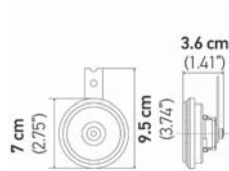

Part Number	Quantity	Description
012588011	2 Pieces	Horns Box (graphic) 12 V, 2 x 16 W, 380 / 480 Hz - Universal Diameter Measurements: 7 cm 7 x 9.5 cm
012588061	1 Piece	High Tone - Box (graphic) Horn 12 V, 16 W, 460 Hz - Universal Diameter Measurements: 7 cm 7 x 9.5 cm

S77 SERIES

DISC HORN | CLASSIC

1x 360 Hz / 1x 430 Hz
 110 ± 3 dB (A)
 2 x 42 W
 12 V
 ≤ 4.0 A
 IP 65
 ECE R28
 80,000x



Housing and bracket in black galvanized metal.
 Level of acoustic intensity at 2 m distance: 111 dB (A).
 Energy consumption: 2 x 42 W
 M8 screw horn bracket.
 Operating Temperature: -40° C a 90° C (-40°F a 194°F)
 With flat connections of 6.3 mm, open, blade type
 With Teflon gasket as protection against moisture.
 Approval: ECE R28

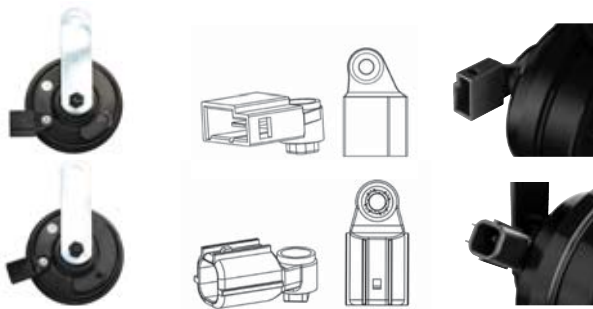

Part Number	Quantity	Description
012588151	2 Pieces	Box (graphic) Horns 12 V, 2 x 42 W, 360/430 Hz - Universal Diameter Measurements: 7.7 cm 4.7 x 10.5 cm
012588351	1 Piece	High Tone - Plastic blister Horn 12 V, 1 x 42 W, 430 Hz - Universal Diameter Measurements: 7.7 cm 4.7 x 10.5 cm Individual presentation in blister pack
011225881	2 Pieces	Horns 12 V, 2 x 42 W, 350/420 Hz - TOYOTA Diameter Measurements: 7.7 cm 4.7 x 10.5 cm With specific connector for Toyota
011225891	2 Pieces	Horns 12 V, 2 x 42 W, 350/420 Hz - HONDA Diameter Measurements: 7.7 cm 4.7 x 10.5 cm With specific connector for Honda



2 Pieces

1 Piece

1 Piece

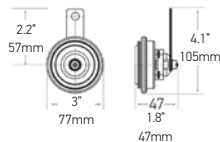

Product image / Dimensions	Features
----------------------------	----------

S92 SERIES

DISC HORN | STRONG TONE



Housing, diaphragm and bracket in black galvanized metal.
 Level of acoustic intensity at 2 m distance: 113 dB(A).
 Energy consumption: 2 x 60 W @ 12 V | 2 x 72 W @ 24 V
 M8 screw horn bracket.
 Operating Temperature: -40° C a 90° C (-40°F a 194°F).
 With flat connections of 6.3 mm, open, blade type.
 Approval: CCC



Part Number	Quantity	Description
011225871	2 Pieces	Box (graphic) Horns 12 V, 2 x 60 W, 335/435 Hz - Universal Diameter Measurements: 9.2 cm 9.2 x 5.6 cm
002768821	2 Pieces	Box (graphic) Horns 24 V, 2 x 72 W, 335/435 Hz - Universal Diameter Measurements: 9.2 cm 9.2 x 5.6 cm
012588071	1 Piece	High Tone - Plastic blister Horn 12 V, 1 x 60 W, 435 Hz - Universal Diameter Measurements: 9.2 cm 9.2 x 5.6 cm
012588141	1 Piece	Low Tone - Plastic blister Horn 12 V, 1 x 60 W, 335 Hz - Universal Diameter Measurements: 9.2 cm 9.2 x 5.6 cm



2 Piece

1 Piece

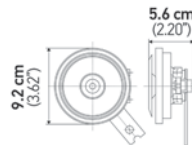
S98 SERIES

DISC HORN | RICH TONE

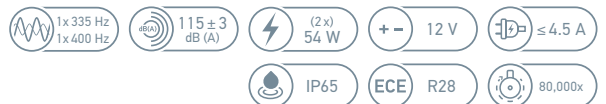

Black housing with red with red diaphragm and galvanized metal bracket.
 Level of acoustic intensity at 2 m distance: 115 dB(A).
 Energy consumption: 54 W
 M8 screw horn bracket.
 Operating Temperature: -40° C a 90° C (-40°F a 194°F)
 With flat connections of 6.3 mm, open, blade type
 Approval: ECE R2



Part Number	Quantity	Description
012588341	2 Pieces	Box (graphic) Horn 12 V, 2 x 54 W, 335 / 400 Hz - Universal Diameter Measurements: 9.8 cm 9.8 x 12.2 cm
012588291	1 Piece	Box (graphic) Low Tone 12 V, 54 W, 400 Hz - Universal Diameter Measurements: 9.8 cm 9.8 x 12.2 cm



2 Pieces

1 Piece

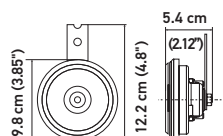

Product image / Dimensions	Features
----------------------------	----------

B36 SERIES
DISC HORN | RICH TONE



Housing and bracket in galvanized metal, black diaphragm
 Level of acoustic intensity at 2 m distance: 116 dB (A).
 Energy consumption: 72 W.
 M8 screw horn bracket.
 Operating Temperature: -40° C a 90° C (-40°F a 194°F)
 Approval: ECE R28



Part Number	Quantity	Description
002768082	1 Piece	Low Tone Horn 12 V, 72 W, 335 Hz - Universal Diameter Measurements: 11.2 cm 5.3 x 12.9 cm
002768551	1 Piece	High Tone Horn 12 V, 72 W, 400 Hz - Universal Diameter Measurements: 11.2 cm 5.3 x 12.9 cm
002768382	1 Piece	Low Tone - 24 V Horn 24 V, 72 W, 335 Hz - Universal Diameter Measurements: 11.2 cm 5.3 x 12.9 cm
002768431	1 Piece	High Tone - 24 V Horn 24 V, 72 W, 400 Hz - Universal Diameter Measurements: 11.2 cm 5.3 x 12.9 cm



1 Piece

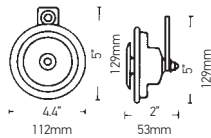

S130 SERIES
DISC HORN | AVANT TONE CHROME



Distinctive look and heavy-duty design
 Level of acoustic intensity at 2 m distance: 118 dB(A).
 Embedded HELLA Logo on the center of the grille
 Black coated housing with a chromed protective grille
 Enhanced low bass sound
 Available for 12 V and 24 V
 Operating Temperature: -40° C a 90° C (-40°F a 194°F)



Part Number	Quantity	Description
004811091	2 Pieces	Box (graphic) Horn 12 V, 2 x 48 W, 280/380 Hz - Universal Diameter Measurements: 13 cm 13 x 8.1 cm
004811071	2 Pieces	Box (graphic) Horn 24 V, 2 x 48 W, 280/380 Hz - Universal Diameter Measurements: 13 cm 13 x 8.1 cm



2 Pieces

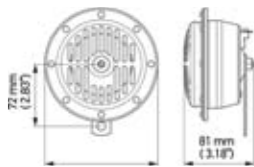

S140 SERIES
DISC HORN | AVANT TONE



Housing and bracket in galvanized metal, black diaphragm
 Level of acoustic intensity at 2 m distance: 118 dB (A).
 Energy consumption: 2 x 48 W.
 M8 screw horn bracket.
 Operating Temperature: -40° C a 90° C (-40°F a 194°F)
 Approval: ECE R28



Part Number	Quantity	Description
004811101	2 Pieces	Horns 12 V, 2 x 48 W, 280 / 380 Hz - Universal Diameter Measurements: 14.4 cm 14.4 x 82.4 cm
004811081	2 Pieces	Horns 12 V, 2 x 48 W, 280 / 380 Hz - Universal Diameter Measurements: 14.4 cm 14.4 x 82.4 cm



2 Pieces

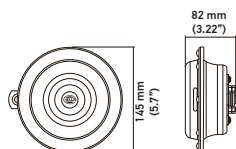

Product image / Dimensions	Features
----------------------------	----------

S108 SERIES

DISC HORN | SHARP TONE



2 Pieces

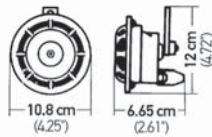

Black housing and bracket, yellow protective grid and blue diaphragm in galvanized metal.
 Level of acoustic intensity at 2 m distance: 115 dB(A).
 Energy consumption: 2 x 42 W.
 M8 screw horn bracket.
 Operating Temperature: -40° C a 90° C (-40°F a 194°F)
 With flat connections of 6.3 mm, open, blade type
 Approval: ECE R28



Part Number	Quantity	Description
003399911	2 Pieces	Horns 12 V, 2 x 42 W, 350 / 415 Hz - Universal Diameter Measurements: 10.8 cm 6.65 x 12.2 cm

B133 SERIES

DISC HORN | SUPER TONE

 2 Pieces
1 Relay

1 Piece

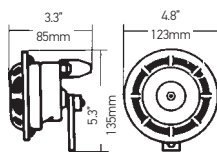

**Extremely concentrated sound radiation and powerful range.
 Particularly suitable for traffic on motorways.**

Black housing, diaphragm and bracket, red protective grille, in galvanized metal.
 Level of acoustic intensity at 2 m distance: 118 dB(A).
 Energy consumption: 2 x 66 W
 M8 screw horn bracket.
 Operating Temperature: -40° C a 90° C (-40°F a 194°F)
 With flat connections of 6.3 mm, open, blade type
 Approval: ECE R28



Part Number	Quantity	Description
003399801	2 Pieces	Box (graphic) Horns 12 V, 2 x 66 W, 300/500 Hz - Universal Diameter Measurements: 12.3 cm 8.5 x 12.5 cm Includes 12 V Relay
358114051	1 Piece	High Tone - Box (yellow) Horn 12 V, 1 x 66 W, 500 Hz - Universal Diameter Measurements: 12.3 cm 8.5 x 12.5 cm

B133 SERIES

24 V DISC HORN | SUPER TONE



2 Pieces

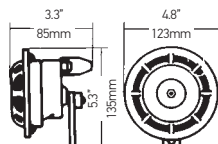

Black housing, protective grille and bracket, in galvanized metal.
 Level of acoustic intensity at 2 m distance: 118 dB(A).
 Energy consumption: 2 x 84 W @ 24 V
 M8 screw horn bracket.
 Operating Temperature: -40° C a 90° C (-40°F a 194°F)
 With flat connections of 6.3 mm, open, blade type. Approval: ECE R28



Part Number	Quantity	Description
003399101	2 Pieces	Horns 24 V, 2 x 84 W, 375/500 Hz - Universal Diameter Measurements: 12.3 mm 8.5 x 12.5 cm
003399061	1 Piece	Low Tone Horns 24 V, 1 x 84 W, 375 Hz - Universal Diameter Measurements: 12.3 cm 8.5 x 12.5 cm
003399071	1 Piece	High Tone Horns 24 V, 1 x 84 W, 500 Hz - Universal Diameter Measurements: 12.3 cm 8.5 x 12.5 cm

Product image / Dimensions

Features

B133 SERIES

24 V DISC HORN | SUPER TONE

Housing and bracket in galvanized metal, black diaphragm
 Level of acoustic intensity at 2 m distance: 115 dB (A).
 Energy consumption: 66 W.
 M8 screw horn bracket.
 Operating Temperature: -40° C a 90° C (-40°F a 194°F)
 With flat connections of 6.3 mm, open, blade type. Approval: ECE R28



002952811 / 002952861

006958901



1 Piece

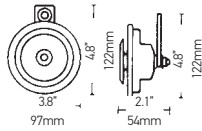

Part Number	Quantity	Description
002952811	1 Piece	High tone Horn 12 V, 66 W, 400 Hz - Universal, silver Diameter Measurements: 9.7 mm 5.4 x 12.2 cm
002952861	1 Piece	Low Tone Horn 12 V, 66 W, 335 Hz - Universal, silver Diameter Measurements: 9.7 mm 5.4 x 12.2 cm
006958901	1 Piece	Low Tone Horn 12 V, 66 W, 335 Hz - Universal, black Diameter Measurements: 9.7 mm 5.4 x 12.2 cm

DL50 SERIES

DISC HORN | HEAVY TONE

Black housing and bracket in galvanized metal.
 Level of acoustic intensity at 2 m distance: 114 dB(A).
 Energy consumption: 72 W
 M8 screw horn bracket.
 Operating Temperature: -40° C a 90° C (-40°F a 194°F)
 With flat connections of 6.3 mm, open, blade type. Approval: ECE R28



1 Piece



2 Pieces

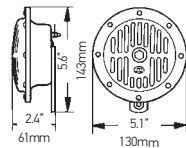

Part Number	Quantity	Description
004811042	1 Piece	Horn Set 12 V, 2 x 72 W, 310 / 380 Hz - Universal Diameter Measurements: 13 cm 6.1 x 14.3 cm
004811001	1 Piece	Low Tone, Horn 12 V, 72 W, 310 Hz - Universal Diameter Measurements: 13 cm 6.1 x 14.3 cm
004811011	1 Piece	High Tone, Horn 12 V, 72 W, 380 Hz - Universal Diameter Measurements: 13 cm 6.1 x 14.3 cm
004811132	1 Piece	Horn Set 24 V, 2 x 84 W, 310 / 380 Hz - Universal Diameter Measurements: 13 cm 6.1 x 14.3 cm
004811021	1 Piece	Low Tone, Horn 24 V, 84 W, 310 Hz - Universal Diameter Measurements: 13 cm 6.1 x 14.3 cm
004811031	1 Piece	High Tone, Horn 24 V, 84 W, 380 Hz - Universal Diameter Measurements: 13 cm 6.1 x 14.3 cm

TE20 SERIES

TRUMPET HORN | BLACK SLEEK

ABS plastic housing and galvanized metal bracket
 Level of acoustic intensity at 2 m distance: 113 dB(A).
 Energy consumption: 2 x 72 W.
 M8 screw horn bracket.
 Operating Temperature: -40° C a 90° C (-40°F a 194°F)
 With flat connections of 6.3 mm, open, blade type. Approval: CCC



2 Pieces



2 Pieces



Part Number	Quantity	Description
011225831	2 Pieces	Box (graphic) Trumpets 12 V, 2 x 72 W, 400 / 500 Hz - Universal Diameter Measurements: 8.6 cm 8.6 x 10.9 cm
012010971	2 Pieces	Plastic blister Horn 12 V, 2 x 72 W, 400 / 500 Hz - Universal Diameter Measurements: 8.6 cm 8.6 x 10.9 cm

Product image / Dimensions	Features
----------------------------	----------

TE24 SERIES

TRUMPET HORN | RED TWIN TONE

1x 400 Hz
1x 500 Hz
 110 ± 3 dB(A)
 (2x) 72 W
 +- 12 V
 ≤ 6.0 A

IP 65
 ECE R28
 100,000x



ABS plastic housing and black bracket in galvanized metal.
 Level of acoustic intensity at 2 m distance: 110 dB(A).
 Energy consumption: 2 x 72 W.
 M8 screw horn bracket.
 Operating Temperature: -40° C a 90° C (-40°F a 194°F)
 With flat connections of 6.3 mm, open, blade type
 Approval: ECE R28
 Includes 12 V Relay

Part Number	Quantity	Description
007424801	2 Pieces	Trumpets 12 V, 2 x 72 W, 400 / 500 Hz - Universal Diameter Measurements: 8.1 cm 8 x 10.9 cm Red Horn
	1 Piece	Includes 12 V Relay

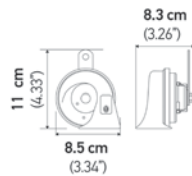
 2 Pieces
1 Relay

TE24 SERIES

TRUMPET HORN | RED TWIN TONE

1x 400 Hz
1x 500 Hz
 110 ± 3 dB(A)
 (2x) 72 W
 +- 12 V
 ≤ 6.0 A

IP 65
 ECE R28
 100,000x



ABS plastic housing and black bracket in galvanized metal.
 Level of acoustic intensity at 2 m distance: 110 dB(A).
 Energy consumption: 2 x 72 W.
 M8 screw horn bracket.
 Operating Temperature: -40° C a 90° C (-40°F a 194°F)
 With flat connections of 6.3 mm, open, blade type
 Approval: ECE R28

Part Number	Quantity	Description
012010801	2 Pieces	Box (graphic) Trumpets 12 V, 2 x 72 W, 400 / 500 Hz - Universal Diameter Measurements: 8.1 cm 8 x 10.9 cm Blue Horn
012010821	2 Pieces	Box (graphic) Trumpets 12 V, 2 x 72 W, 400 / 500 Hz - Universal Diameter Measurements: 8.1 cm 8 x 10.9 cm Yellow Horn
007424001	1 Piece	Low Tone - Box (yellow) Horn 12 V, 1 x 72 W, 400 - Universal Diameter Measurements: 8.1 cm 8 x 10.9 cm Red Horn
007424011	1 Piece	High Tone - Box (yellow) Horn 12 V, 1 x 72 W, 500 - Universal Diameter Measurements: 8.1 cm 8 x 10.9 cm Red Horn



1 Piece



2 Pieces

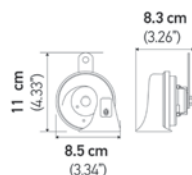



Product image / Dimensions	Features
----------------------------	----------

TE26 SERIES

TRUMPET HORN | QUICK FIT



ABS plastic housing and black bracket in galvanized metal.
 Level of acoustic intensity at 2 m distance: 113 dB(A).
 Energy consumption: 2 x 72 W.
 M8 screw horn bracket.
 Operating Temperature: -40° C a 80° C (-40°F a 176°F)
 With flat connections of 6.3 mm, open, blade type
 Approval: ECE R28, CCC

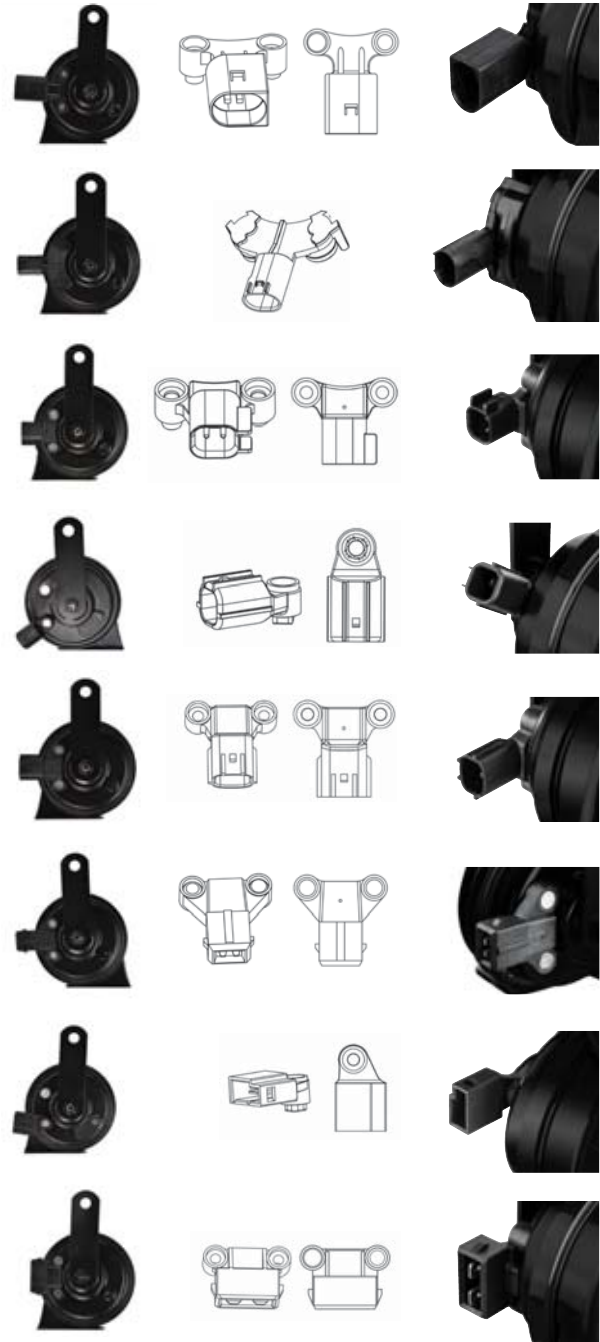

Part Number	Quantity	Description
011225841	2 Pieces.	Horns 12 V, 2 x 72 W, 400 / 500 Hz - AUDI / VW Diameter Measurements: 8.6 cm 8.6 x 10.9 cm With specific connector
012010881	2 Pieces.	Horns 12 V, 2 x 72 W, 400 / 500 Hz - BMW / MINI Diameter Measurements: 8.6 cm 8.6 x 10.9 cm With specific connector
011225921	2 Pieces.	Horns 12 V, 2 x 72 W, 400 / 500 Hz - FORD Diameter Measurements: 8.6 cm 8.6 x 10.9 cm With specific connector
012010911	2 Pieces.	Horns 12 V, 2 x 72 W, 400 / 500 Hz - HONDA Diameter Measurements: 8.6 cm 8.6 x 10.9 cm With specific connector
011225901	2 Pieces.	Horns 12 V, 2 x 72 W, 400 / 500 Hz - HYUNDAI / KIA Diameter Measurements: 8.6 cm 8.6 x 10.9 cm With specific connector
012010891	2 Pieces.	Horns 12 V, 2 x 72 W, 400 / 500 Hz - PEUGEOT Diameter Measurements: 8.6 cm 8.6 x 10.9 cm With specific connector
012010901	2 Pieces.	Horns 12 V, 2 x 72 W, 400 / 500 Hz - TOYOTA Diameter Measurements: 8.6 cm 8.6 x 10.9 cm With specific connector
011225851	2 Pieces.	Horns 12 V, 2 x 72 W, 400 / 500 Hz - AUDI / VOLKSWAGEN Diameter Measurements: 8.6 cm 8.6 x 10.9 cm With specific connector



2 Pieces

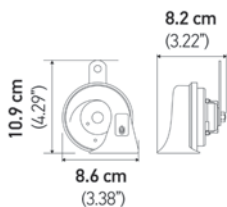

Product image / Dimensions	Features
----------------------------	----------

TE30 SERIES
TRUMPET HORN | CHROME TWIN TONE

Horn chrome or gold version

Special Edition

2 Pieces

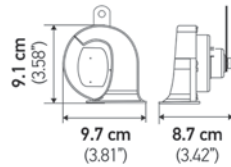

ABS plastic housing and galvanized metal bracket.
 Level of acoustic intensity at 2 m distance: 112 dB(A).
 Energy consumption: 2 x 60 W
 M8 screw horn bracket.
 Operating Temperature: -40° C a 90° C (-40°F a 194°F).
 With flat connections of 6.3 mm, open, blade type.

Part Number	Quantity	Description
007728883	2 Pieces	Trumpets 12 V, 2 x 60 W, 410 / 510 Hz - Universal Diameter Measurements: 8.6 cm 9.1 x 9.7 x 8.7 cm Chrome Horn
007728893	2 Pieces	Trumpets 12 V, 2 x 60 W, 410 / 510 Hz - Universal Diameter Measurements: 8.6 cm 9.1 x 9.7 x 8.7 cm Gold Horn

TE30 SERIES
24 V TRUMPET HORN | HARMONIC

2 Pieces

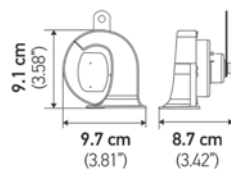

ABS plastic housing and galvanized metal bracket.
 Level of acoustic intensity at 2 m distance: 110 dB(A)
 Energy consumption: 2 x 72 W
 M8 screw horn bracket.
 Operating Temperature: -40° C a 90° C (-40°F a 194°F)
 With flat connections of 6.3 mm, open, blade type

Part Number	Quantity	Description
940800821	2 Pieces	Trumpets 24 V, 2 x 72 W, 410 / 510 Hz - Universal Diameter Measurements: 8.6 cm 9.1 x 9.7 x 8.7 cm Black Horn

TE40 SERIES
ELECTRONIC TRUMPET HORN | FIT & FORGET

2 Pieces

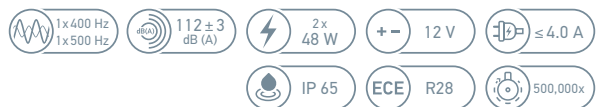
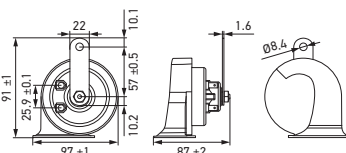

Ultra-Long service life.
 Switching mechanism is replaced by an electronic component.
 Provide 3 years HELLA quality warranty to end consumers.
 With 6.3 mm blade terminal contacts, open.
 Bracket on horn for M8 fixing screw.

Part Number	Quantity	Description
007728981	2 Pieces	Trumpets 12 V, 2 x 48 W, 400 / 500 Hz - Universal Diameter Measurements: 9.7 cm 9.1 x 9.7 x 8.7 cm Black Horn

AIR TRUMPETS

Efficient sound

HELLA compressed air trumpets produce a penetrating and long range sound. Ideal for carriers that need to be heard in traffic.

HELLA trumpets are finished in durable materials, their sound is penetrating, and their design is striking, resistant to inclement weather.



Product image /
Dimensions

Features

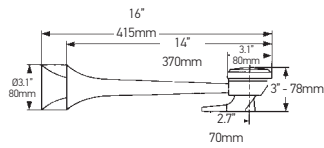
CA34 SERIES
CHROME TWIN TONE AIR HORN | HIGH WAY

For vehicles with a compressed air brake system.
Chromed lid and trumpet, matt black base
Pneumatic operation
Level of acoustic intensity at 2 m distance: 118 dB(A).
Energy consumption: 0 - 20 W.
Suitable for tubular fittings Ø 8 mm.
2 holes for fixing screws M10.
Approval: ECE
Pressure Range: 4 - 8.3 bar

Part Number	Quantity	Description
005411001	1 Piece	Compressed air horn 24 V, 0 -20 W, 300 - 350 Hz - Universal Measurements: 7.8 x 16 x 41.5 cm

1

2

Accessories

The horn can be operated in three different ways:

Part Number	Quantity	Description
715989001	1 Set	Mounting on the roof of the cab. Drive pulling the pull cable coated, 120 cm long. Traction Valve.
715991001	1 Set	Mounting in the engine compartment. Drive by pressing Horn button. With flat connections of 6.3 mm, open. Power absorbed: 20W. Electric valve, 24V.

Product image / Dimensions

Features

CA26 SERIES

ELECTROPNEUMATIC HORN | COMPACT



1 Piece

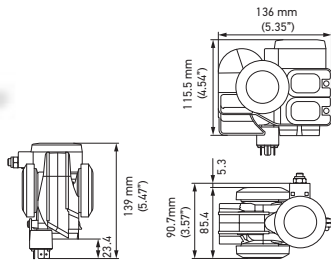

Super compact design with horn and air compressor in one module. The integrated compressor enables immediate sound output. Necessary mounting kits and relay are included. ABS housing. Level of acoustic intensity at 2 m distance: 112 dB(A). Energy consumption: 120 W. Mounting bracket included. Approval: ECE. Operating Temperature: -40° C a 75° C (-40°F a 167°F)

Part Number	Quantity	Description
013410081	1 Piece	1 Electropneumatic horn 12 V, 120 W, 520 / 660 Hz - Universal
013410091	1 Piece	1 Electropneumatic horn 24 V, 120 W, 520 / 660 Hz - Universal

CA10 SERIES

RED TWIN TONE AIR HORN | LOUD



1 Piece
1 Relay

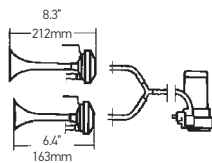

Compressed air horn with ABS plastic body and support in galvanized metal. Level of acoustic intensity at 2 m distance: 118 dB(A). Energy consumption: 240 W. Mounting bracket included. Operating Temperature: -40° C a 90° C (-40°F a 194°F). Approval: ECE

Part Number	Quantity	Description
003001651	1 Set	2 Electric Horns - Pneumatic 12 V, 240 W, 780 / 840 Hz - Universal Length of Trumpets: 16.3 cm 21.2 cm Includes compressor, pressure tubes, bifurcated Piece Fastening and Relay 12 V
003001661	1 Set	2 Electric Trumpets - Pneumatic 24 V, 240 W, 780 / 840 Hz - Universal Length of Trumpets: 16.3 mm 21.2 cm Includes compressor, pressure tubes, bifurcated Piece Fastening and Relay 24 V

CA12 SERIES

RED TRIPLE TONE AIR HORN | LOUD



1 Piece
1 Relay

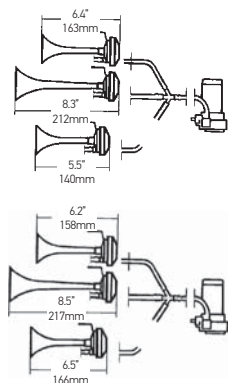

Compressed air horns with ABS plastic body and support in galvanized metal. Level of acoustic intensity at 2 m distance: 118 dB(A). Energy consumption: 240 W. Mounting bracket included. Operating Temperature: -40° C a 90° C (-40°F a 194°F). Approval: ECE

Part Number	Quantity	Description
003001671	1 Set	3 Electric Horns - Pneumatic 12 V, 240 W, 780 / 820 / 880 Hz - Universal Length of Trumpets: 14 cm 16.3 cm 21.2 cm Includes compressor, pressure tubes, bifurcated Piece Fastening and Relay 12 V
003001981	1 Set	3 Electric Trumpets - Pneumatic Melodic Sound 12 V, 240 W, 630 / 795 / 840 Hz - Universal Length of Trumpets: 15.8 cm 16.6 cm 21.7 cm Includes compressor, pressure tubes, bifurcated Piece Fastening and Relay 12 V

Product image / Dimensions	Features
----------------------------	----------

CA30 SERIES
CHROME SINGLE TONE AIR HORN | SUPER LOUD

370 Hz
 ≥ 120 dB (A)
 312 W
 12/24 V
 IP 54
 ECE R28
 50,000x

Pneumatic operation
 Level of acoustic intensity at 2 m distance: 115 dB(A).
 Energy consumption: 312 W.
 Robust housing. With flat connections of 6.3 mm, open, blade type.
 2 holes for M10 fixing screws.
 Includes compressor, pressure tubes, fastening and Relay 12 V
 Pressure Range: 0.98 bar

Part Number	Quantity	Description
013410001	1 Set	Air Horn using compressed air - Single tone 12 V, 312 W - Universal
013410021	1 Set	Air Horn using compressed air - Single tone 24 V, 312 W - Universal

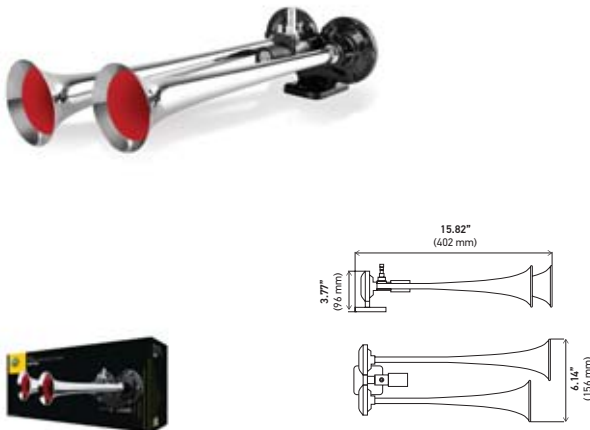
CA30 SERIES
CHROME DUAL TONE AIR HORN | SUPER LOUD

≥ 125 dB (A)
 41 W / 77 W
 12/24 V

For vehicles with compressed air braking system.
 Level of acoustic intensity at 2 m distance: 125 dB(A).
 Robust housing.
 With flat connections of 6.3 mm, open, blade type
 Pressure Range: 6 - 8 bar (87 - 116 PSI)

Part Number	Quantity	Description
013410051	1 Piece.	Dual tone compressed air horn - Box 12 V, 41 W - Universal Measurements: 40.2 x 9.6 x 15.6 cm
013410061	1 Piece.	Dual tone compressed air horn - Box 24 V, 77 W - Universal Measurements: 40.2 x 9.6 x 15.6 cm
715991031	1 Set	Replacement solenoid for air trumpet - 12 V
715991041	1 Set	Replacement solenoid for air trumpet - 24 V

CA20 SERIES
SINGLE TONE AIR HORN | SUPER LOUD

400 Hz
 ≥ 118 dB (A)
 120 W
 12-24 V
 IP 54
 ECE R28
 50,000x

For vehicles with a compressed air brake system.
 Pneumatic operation
 Level of acoustic intensity at 2 m distance: 115 dB(A).
 Energy consumption: 120 W.
 Robust Housing
 Suitable for tubular fittings Ø 8 mm. 2 holes for M10 fixing screws.
 Pressure Range: 5.88 bar

Part Number	Quantity	Description
013410011	1 Piece	Compressed air horn - Single tone 12 - 24 V, 120 W - Universal Measurements: 11.6 x 14.4 x 20.3 cm



BACKUP ALARMS

Safety above all



In some countries, regulations require the installation of a reverse alarm when motor vehicles have obstructed eyesight to the rear. The vehicle must have an audible reverse alarm above the surrounding noise level. Unless, the vehicle is backed up when an observer indicates that it is safe to do so.

All bidirectional machines, such as rollers, compactors, front loaders, bulldozers and similar equipment, must be equipped with a reverse alarm, which will be differentiated from the surrounding noise level and which will be operated as necessary when the machine is in motion. The reverse alarm has to be maintained in operating conditions. Many of the regulations require a sound level greater than 90 dB.



Product image / Dimensions	Features
----------------------------	----------

BM10 SERIES

BACK-UP ALARM | WIDE VOLTAGE

110 ± 3 dB (A)
 12 W
 12-48 V
 ≤ 0.6 A
 IP 67

R10
 300,000x



1 Piece



1 Piece

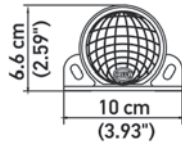

Black plastic housing.
 With integrated bracket for universal mounting.
 The level of sound intensity is generated by the electronics of solid bodies.
 Level of acoustic intensity at 2 m distance: 110 dB (A).
 Multivoltage: 9 V - 48 V
 Rated Continuous Current: 0.1 - 0.6 A
 Operating temperature: -40 °C to +85 °C.
 Protection class: IP67 (Resistant to water immersions)
 Approval: ECE R10 / 107 dB

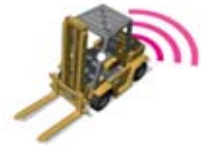

Part Number	Quantity	Description
009148142	1 Piece	Backup Alarm - Plastic blister Multivolt: 9 - 48 V - Universal Protection Class: IP67K Measurements: 10.1 x 3.9 x 6.5 cm
009148141	1 Piece	Backup Alarm - Box Multivolt: 9 - 48 V - Universal Protection Class: IP67K Measurements: 10.1 x 3.9 x 6.5 cm
009148161	1 Piece	Backup Alarm - Box - with grounding strap Multivolt: 9 - 48 V - Universal Protection Class: IP67K Measurements: 10.1 x 3.9 x 6.5 cm
009148221	1 Piece	Backup Alarm - Box - with grounding strap, SAE J994 Type C, 102 dB (A) Multivolt: 9 - 48 V - Universal Protection Class: IP67K Measurements: 10.1 x 3.9 x 6.5 cm

Ask your sales representative about product availability in your region

BM30 SERIES

BACK-UP ALARM | HEAVY DUTY

112 ± 3 dB (A)
 12 W
 12-48 V
 ≤ 0.6 A
 IP 67

R10
 500,000x

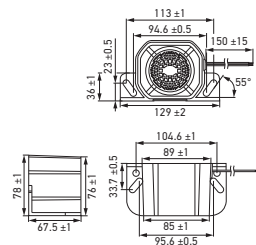

Heavy duty design for demanding applications.
 Insulated electronics with epoxy to protect against dust and vibrations.
 Great fit for excavators and other construction equipment.
 With 150 mm wiring harness.
 Integral bracket includes popular OEM mounting pattern

Part Number	Quantity	Description
996139301	1 Piece	Backup Alarm BX30 - Box Multivolt: 12-48 V - Universal

BX10 SERIES

BACK-UP ALARM

90 ± 3 dB (A)
 5.5 W
 12-24 V



1 Piece

Black plastic housing.
 With integrated bracket for universal mounting.
 Level of acoustic intensity at 2 m distance: 90 dB (A).
 Multivoltage: 12 V - 24 V
 Rated Power Consumption of 5.5 Watts
 Operating temperature: -40 °C to +85 °C.

Part Number	Quantity	Description
009148501	1 Piece	Backup Alarm BX10 - Box Multivolt: 12-24 V - Universal

Product image / Dimensions	Features
----------------------------	----------

BX10 SERIES

BACK-UP ALARM

1200 Hz
 112 ± 3 dB (A)
 12-36 V



Black steel housing.
 With integrated bracket for universal mounting.
 The level of sound intensity is generated by the solid body electronics.
 Approved against electromagnetic tolerance and according to SAE.
 With protection against reverse polarity and voltage points.
 Operating temperature: -40 ° C to +85 ° C.
 60 signals per minute.
 Protection class: IP5K9K, CE, SAE J994, E11.

Part Number	Quantity	Description
996139001	1 Piece	Reverse Alarm With automatic adaptation to the environment with variable acoustic level. The solid body electronics is automatically set to 5 dB (A) above the ambient acoustic level. With connection cable of 16 cm long Voltage: 12V - 24V. Current consumption: 0.59A - 0.71A. Acoustic level: 87-112 dB (A) (1.2 m). Frequency: 1200 Hz ± 20%.
996139101	1 Piece	Reverse Alarm. With connection cable 16 cm long Voltage: 12V - 36V. Current consumption: 0.4A. Acoustic level: 107 dB (A) (1.2 m). Frequency: 1300 Hz ± 20%.
996139111	1 Piece	Reverse Alarm. With connection cable 16 cm long Voltage: 12V - 36V. Current consumption: 0.4A. Acoustic level: 112 dB (A) (1.2 m). Frequency: 1250 Hz ± 20%.



1 Piece

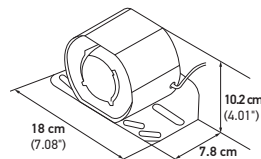

BM20 SERIES

BACK-UP ALARM | AMP PLUG

12 W
 12-24 V
 IP 67
 ECE R10
 300,000x



Black plastic housing.
 With integrated bracket for universal mounting.
 The level of sound intensity is generated by the electronic of solid bodies.
 Approved against electromagnetic tolerance and according to SAE.
 With protection against reverse polarity and voltage points.
 Operating temperature: -40 ° C to +85 ° C.
 Frequency: 60 signals per minute; 1250 Hz ± 20% .

Part Number	Quantity	Description
009148001	1 Piece	Reverse Alarm. Voltage: 12V - 24V. Current consumption: 0.1A - 0.2A. Acoustic level: 90 dB (A) (1.2 m), with integrated AMP plug.
009148011	1 Piece	Reverse Alarm. Voltage: 12V - 24V. Current consumption: 0.3A - 0.4A. Acoustic level: 97 dB (A) (1.2 m), with integrated AMP plug.
009148021	1 Piece	Reverse Alarm. Voltage: 12V - 24V. Current consumption: 0.6A - 0.7A. Acoustic level: 107 dB (A) (1.2 m), with integrated AMP plug.



1 Piece

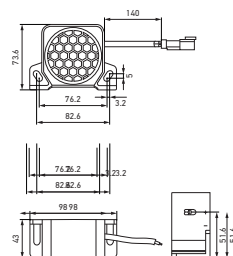

RELEASE THE BEAST!

ENJOY THE URBAN JUNGLE
THE HELLA HORNS RANGE



THE
WORKSHOP'S
FRIEND



THE ULTIMATE IN THE ART OF RELAYS



CATALOG: Download the latest version of the Relays catalog











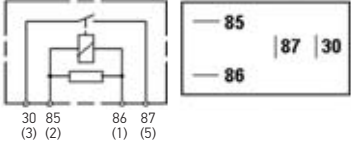

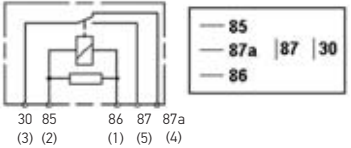

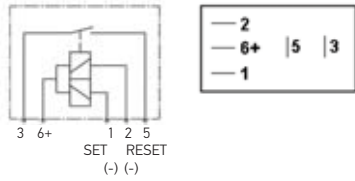

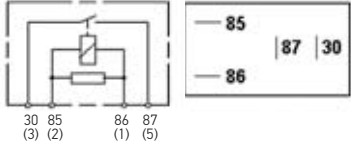

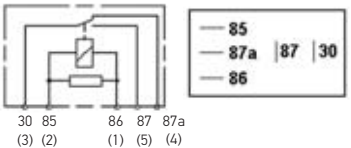

UPDATED!

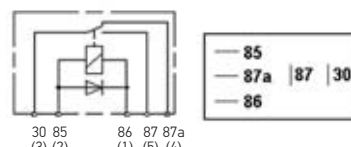

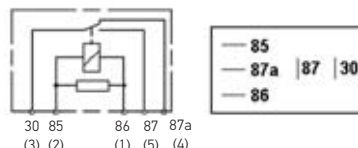

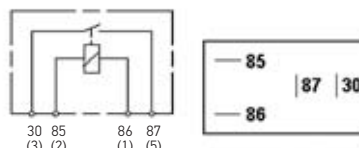

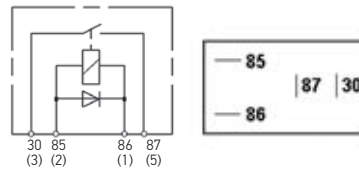

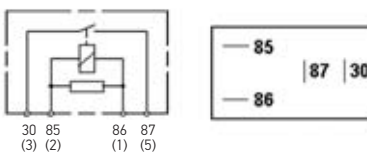
MICROSITE: Consult vehicle specific application in our website for detailed information:

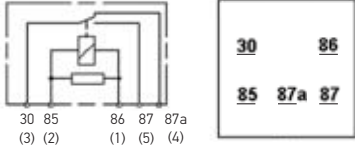

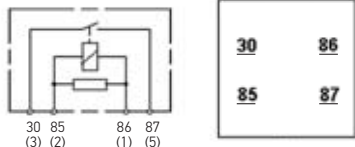

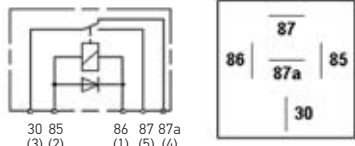

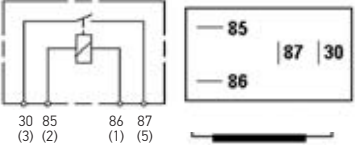

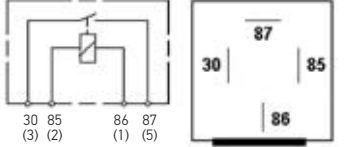
<https://hella.mypartfinder.com/>

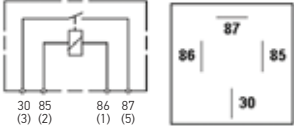

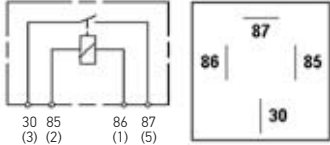

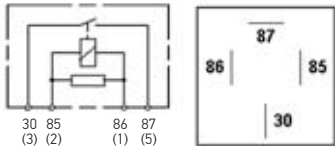

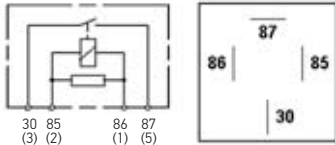

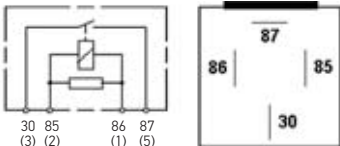

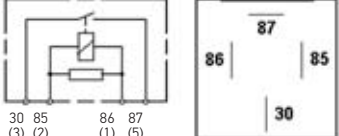
Product image / Dimensions	Features	Part Number	Technical Specifications						
<p>Micro Relay ISO</p> 	<ul style="list-style-type: none"> • 12 V • SPST / Form A • 35 Amp • Resistor Coil Suppression 	<p>933766801</p> <p>Technical Data</p>	<p>Minimum Order Quantity: 1</p> <table border="1"> <tr> <td>Rated Voltage</td> <td>12 V</td> </tr> <tr> <td>Rated Current</td> <td>35A at 85°C</td> </tr> <tr> <td>Contact Form</td> <td>1 Form A / SPST N/O</td> </tr> </table>	Rated Voltage	12 V	Rated Current	35A at 85°C	Contact Form	1 Form A / SPST N/O
Rated Voltage	12 V								
Rated Current	35A at 85°C								
Contact Form	1 Form A / SPST N/O								
<p>Micro Relay ISO</p> 	<ul style="list-style-type: none"> • 12 V • SPDT / Form C • 35 Amp • Resistor Coil Suppression 	<p>965453801</p> <p>Technical Data</p>	<p>Minimum Order Quantity: 1</p> <table border="1"> <tr> <td>Rated Voltage</td> <td>12 V</td> </tr> <tr> <td>Rated Current</td> <td>N/O 35A N/C 20A at 85°C</td> </tr> <tr> <td>Contact Form</td> <td>1 Form C / SPDT</td> </tr> </table>	Rated Voltage	12 V	Rated Current	N/O 35A N/C 20A at 85°C	Contact Form	1 Form C / SPDT
Rated Voltage	12 V								
Rated Current	N/O 35A N/C 20A at 85°C								
Contact Form	1 Form C / SPDT								
<p>Micro Relay ISO</p> 	<ul style="list-style-type: none"> • 12 V • SPST / Form A • 30 Amp • Bistable / Magnetic Latching 	<p>933364027</p> <p>Technical Data</p>	<p>Minimum Order Quantity: 1</p> <table border="1"> <tr> <td>Rated Voltage</td> <td>12 V</td> </tr> <tr> <td>Rated Current</td> <td>30A at 85°C</td> </tr> <tr> <td>Contact Form</td> <td>1 Form A / SPST N/O</td> </tr> </table>	Rated Voltage	12 V	Rated Current	30A at 85°C	Contact Form	1 Form A / SPST N/O
Rated Voltage	12 V								
Rated Current	30A at 85°C								
Contact Form	1 Form A / SPST N/O								
<p>Micro Relay ISO</p> <p>NEW!</p> 	<ul style="list-style-type: none"> • 24 V • SPST / Form A • Resistor Coil Suppression • 40 Amp • Combo 6.3 & 2.8 mm Terminals 	<p>933714501</p> <p>Technical Data</p>	<p>Minimum Order Quantity: 1</p> <table border="1"> <tr> <td>Voltaje Nominal</td> <td>24 V</td> </tr> <tr> <td>Rated Current</td> <td>40A at 85°C</td> </tr> <tr> <td>Contact Form</td> <td>1 Form A / SPST N/O</td> </tr> </table>	Voltaje Nominal	24 V	Rated Current	40A at 85°C	Contact Form	1 Form A / SPST N/O
Voltaje Nominal	24 V								
Rated Current	40A at 85°C								
Contact Form	1 Form A / SPST N/O								
<p>Micro Relay ISO</p> <p>NEW!</p> 	<ul style="list-style-type: none"> • 24 V • SPDT / Form C • Resistor Coil Suppression • 40 Amp • Combo 6.3 & 2.8 mm Terminals 	<p>933713501</p> <p>Technical Data</p>	<p>Minimum Order Quantity: 1</p> <table border="1"> <tr> <td>Voltaje Nominal</td> <td>24 V</td> </tr> <tr> <td>Rated Current</td> <td>20A / 40A at 85°C</td> </tr> <tr> <td>Contact Form</td> <td>1 Form C / SPDT</td> </tr> </table>	Voltaje Nominal	24 V	Rated Current	20A / 40A at 85°C	Contact Form	1 Form C / SPDT
Voltaje Nominal	24 V								
Rated Current	20A / 40A at 85°C								
Contact Form	1 Form C / SPDT								

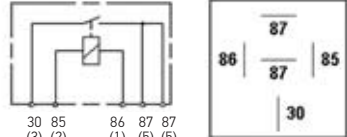
Product image / Dimensions	Features	Part Number	Technical Specifications						
<p>Micro Relay ISO</p> <p>NEW!</p> 	<ul style="list-style-type: none"> • 24 V • SPDT / Form C • Diode Coil Suppression • 20 Amp • Micro ISO Footprint 	<p>933714611</p> <p>Technical Data</p> <table border="1"> <tr> <td>Voltage Nominal</td> <td>24 V</td> </tr> <tr> <td>Rated Current</td> <td>10A / 20A at 85°C</td> </tr> <tr> <td>Contact Form</td> <td>1 Form C / SPDT</td> </tr> </table>	Voltage Nominal	24 V	Rated Current	10A / 20A at 85°C	Contact Form	1 Form C / SPDT	<p>Minimum Order Quantity: 1</p>
Voltage Nominal	24 V								
Rated Current	10A / 20A at 85°C								
Contact Form	1 Form C / SPDT								
<p>Micro Relay ISO</p> <p>NEW!</p> 	<ul style="list-style-type: none"> • 24 V • SPDT / Form C • Resistor Coil Suppression • 20 Amp • Micro ISO Footprint 	<p>933714621</p> <p>Technical Data</p> <table border="1"> <tr> <td>Voltage Nominal</td> <td>24 V</td> </tr> <tr> <td>Rated Current</td> <td>10A / 20A at 85°C</td> </tr> <tr> <td>Contact Form</td> <td>1 Form C / SPDT</td> </tr> </table>	Voltage Nominal	24 V	Rated Current	10A / 20A at 85°C	Contact Form	1 Form C / SPDT	<p>Minimum Order Quantity: 1</p>
Voltage Nominal	24 V								
Rated Current	10A / 20A at 85°C								
Contact Form	1 Form C / SPDT								
<p>Micro Relay ISO</p> <p>NEW!</p> 	<ul style="list-style-type: none"> • 24 V • SPST / Form A • 20 Amp • Micro ISO Footprint 	<p>933714631</p> <p>Technical Data</p> <table border="1"> <tr> <td>Voltage Nominal</td> <td>24 V</td> </tr> <tr> <td>Rated Current</td> <td>20A at 85°C</td> </tr> <tr> <td>Contact Form</td> <td>1 Form A / SPST N/O</td> </tr> </table>	Voltage Nominal	24 V	Rated Current	20A at 85°C	Contact Form	1 Form A / SPST N/O	<p>Minimum Order Quantity: 1</p>
Voltage Nominal	24 V								
Rated Current	20A at 85°C								
Contact Form	1 Form A / SPST N/O								
<p>Micro Relay ISO</p> <p>NEW!</p> 	<ul style="list-style-type: none"> • 24 V • SPST / Form A • Diode Coil Suppression • 20 Amp • Micro ISO Footprint 	<p>933714641</p> <p>Technical Data</p> <table border="1"> <tr> <td>Voltage Nominal</td> <td>24 V</td> </tr> <tr> <td>Rated Current</td> <td>20A at 85°C</td> </tr> <tr> <td>Contact Form</td> <td>1 Form A / SPST N/O</td> </tr> </table>	Voltage Nominal	24 V	Rated Current	20A at 85°C	Contact Form	1 Form A / SPST N/O	<p>Minimum Order Quantity: 1</p>
Voltage Nominal	24 V								
Rated Current	20A at 85°C								
Contact Form	1 Form A / SPST N/O								
<p>Mini Relay ISO</p> <p>NEW!</p> 	<ul style="list-style-type: none"> • 24 V • SPST / Form A • Resistor Coil Suppression • 20 Amp • Micro ISO Footprint 	<p>933714651</p> <p>Technical Data</p> <table border="1"> <tr> <td>Voltage Nominal</td> <td>24 V</td> </tr> <tr> <td>Rated Current</td> <td>20A at 85°C</td> </tr> <tr> <td>Contact Form</td> <td>1 Form A / SPST N/O</td> </tr> </table>	Voltage Nominal	24 V	Rated Current	20A at 85°C	Contact Form	1 Form A / SPST N/O	<p>Minimum Order Quantity: 1</p>
Voltage Nominal	24 V								
Rated Current	20A at 85°C								
Contact Form	1 Form A / SPST N/O								

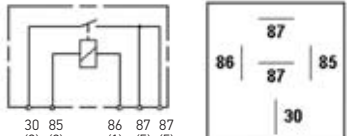
Product image / Dimensions	Features	Part Number	Technical Specifications						
<p>Micro Relay ISO</p> <p>NEW!</p> 	<ul style="list-style-type: none"> • 24 V • SPDT / Form C • Resistor Coil Suppression • 20 Amp • 2.8mm Terminals 	<p>933714661</p> <p>Technical Data</p> <table border="1"> <tr> <td>Rated Voltage</td> <td>24 V</td> </tr> <tr> <td>Rated Current</td> <td>10A / 20A at 85°C</td> </tr> <tr> <td>Contact Form</td> <td>1 Form C / SPDT</td> </tr> </table>	Rated Voltage	24 V	Rated Current	10A / 20A at 85°C	Contact Form	1 Form C / SPDT	<p>Minimum Order Quantity: 1</p>
Rated Voltage	24 V								
Rated Current	10A / 20A at 85°C								
Contact Form	1 Form C / SPDT								
<p>Micro Relay ISO</p> <p>NEW!</p> 	<ul style="list-style-type: none"> • 24 V • SPST / Form A • Resistor Coil Suppression • 20 Amp • 2.8mm Terminals 	<p>933714671</p> <p>Technical Data</p> <table border="1"> <tr> <td>Rated Voltage</td> <td>24 V</td> </tr> <tr> <td>Rated Current</td> <td>20A at 85°C</td> </tr> <tr> <td>Contact Form</td> <td>1 Form A / SPST N/O</td> </tr> </table>	Rated Voltage	24 V	Rated Current	20A at 85°C	Contact Form	1 Form A / SPST N/O	<p>Minimum Order Quantity: 1</p>
Rated Voltage	24 V								
Rated Current	20A at 85°C								
Contact Form	1 Form A / SPST N/O								
<p>Mini Relay ISO</p> <p>NEW!</p> 	<ul style="list-style-type: none"> • 12 V • SPDT / Form C • Diode Coil Suppression • 40 Amp • Mini ISO Footprint 	<p>933332371</p> <p>Technical Data</p> <table border="1"> <tr> <td>Rated Voltage</td> <td>12 V</td> </tr> <tr> <td>Rated Current</td> <td>30A / 40A at 85°C</td> </tr> <tr> <td>Contact Form</td> <td>1 Form C / SPDT</td> </tr> </table>	Rated Voltage	12 V	Rated Current	30A / 40A at 85°C	Contact Form	1 Form C / SPDT	<p>Minimum Order Quantity: 1</p>
Rated Voltage	12 V								
Rated Current	30A / 40A at 85°C								
Contact Form	1 Form C / SPDT								
<p>Mini Relay ISO</p> 	<ul style="list-style-type: none"> • 12 V • SPST / Form A • Mounting Bracket • 30 Amp • Alternate Footprint 	<p>965400071</p> <p>965400077</p> <p>Technical Data</p> <table border="1"> <tr> <td>Voltaje Nominal</td> <td>12 V</td> </tr> <tr> <td>Rated Current</td> <td>30A at 85°C</td> </tr> <tr> <td>Contact Form</td> <td>1 Form A / SPST N/O</td> </tr> </table>	Voltaje Nominal	12 V	Rated Current	30A at 85°C	Contact Form	1 Form A / SPST N/O	<p>Minimum Order Quantity: 1</p> <p>Pack - Minimum Order Quantity: 40</p>
Voltaje Nominal	12 V								
Rated Current	30A at 85°C								
Contact Form	1 Form A / SPST N/O								
<p>Mini Relay ISO</p> 	<ul style="list-style-type: none"> • 24 V • SPST / Form A • Mounting Bracket • 30 Amp • Alternate Footprint 	<p>965400101</p> <p>Technical Data</p> <table border="1"> <tr> <td>Voltaje Nominal</td> <td>24 V</td> </tr> <tr> <td>Rated Current</td> <td>30A at 85°C</td> </tr> <tr> <td>Contact Form</td> <td>1 Form A / SPST N/O</td> </tr> </table>	Voltaje Nominal	24 V	Rated Current	30A at 85°C	Contact Form	1 Form A / SPST N/O	<p>Minimum Order Quantity: 1</p>
Voltaje Nominal	24 V								
Rated Current	30A at 85°C								
Contact Form	1 Form A / SPST N/O								

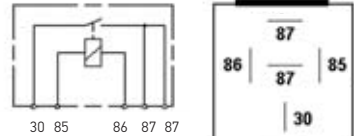
Product image / Dimensions	Features	Part Number	Technical Specifications						
<p>Mini Relay ISO</p> 	<ul style="list-style-type: none"> • 12 V • SPST / Form A • 40 Amp • Dust Cover 	<p>933332451</p> <p>933332457</p> <p>Technical Data</p>	<p>Minimum Order Quantity: 1</p> <p>Pack - Minimum Order Quantity: 40</p> <table border="1"> <tr> <td>Voltaje Nominal</td> <td>12 V</td> </tr> <tr> <td>Rated Current</td> <td>40A at 85°C</td> </tr> <tr> <td>Contact Form</td> <td>1 Form A / SPST N/O</td> </tr> </table>	Voltaje Nominal	12 V	Rated Current	40A at 85°C	Contact Form	1 Form A / SPST N/O
Voltaje Nominal	12 V								
Rated Current	40A at 85°C								
Contact Form	1 Form A / SPST N/O								
<p>Mini Relay ISO</p> 	<ul style="list-style-type: none"> • 24 V • SPST / Form A • 20 Amp • Dust Covers 	<p>933332461</p> <p>Technical Data</p>	<p>Minimum Order Quantity: 1</p> <table border="1"> <tr> <td>Voltaje Nominal</td> <td>24 V</td> </tr> <tr> <td>Rated Current</td> <td>20A at 85°C</td> </tr> <tr> <td>Contact Form</td> <td>1 Form A / SPST N/O</td> </tr> </table>	Voltaje Nominal	24 V	Rated Current	20A at 85°C	Contact Form	1 Form A / SPST N/O
Voltaje Nominal	24 V								
Rated Current	20A at 85°C								
Contact Form	1 Form A / SPST N/O								
<p>Mini Relay ISO</p> 	<ul style="list-style-type: none"> • 12 V • SPST / Form A • Dust Cover • 40 Amp • Resistor Coil Suppression 	<p>933332541</p> <p>Technical Data</p>	<p>Minimum Order Quantity: 1</p> <table border="1"> <tr> <td>Voltaje Nominal</td> <td>12 V</td> </tr> <tr> <td>Rated Current</td> <td>40A at 85°C</td> </tr> <tr> <td>Contact Form</td> <td>1 Form A / SPST N/O</td> </tr> </table>	Voltaje Nominal	12 V	Rated Current	40A at 85°C	Contact Form	1 Form A / SPST N/O
Voltaje Nominal	12 V								
Rated Current	40A at 85°C								
Contact Form	1 Form A / SPST N/O								
<p>Mini Relay ISO</p> 	<ul style="list-style-type: none"> • 24 V • SPST / Form A • Dust Covers • 20 Amp • Resistor Coil Suppression 	<p>007957001</p> <p>007957007</p> <p>Technical Data</p>	<p>Minimum Order Quantity: 1</p> <p>Pack - Minimum Order Quantity: 200</p> <table border="1"> <tr> <td>Voltaje Nominal</td> <td>24 V</td> </tr> <tr> <td>Rated Current</td> <td>20A at 85°C</td> </tr> <tr> <td>Contact Form</td> <td>1 Form A / SPST N/O</td> </tr> </table>	Voltaje Nominal	24 V	Rated Current	20A at 85°C	Contact Form	1 Form A / SPST N/O
Voltaje Nominal	24 V								
Rated Current	20A at 85°C								
Contact Form	1 Form A / SPST N/O								
<p>Mini Relay ISO</p> 	<ul style="list-style-type: none"> • 12 V • SPST / Form A • Mounting Bracket • 40 Amp • Resistor Coil Suppression 	<p>007791021</p> <p>007791027</p> <p>Technical Data</p>	<p>Minimum Order Quantity: 1</p> <p>Pack - Minimum Order Quantity: 200</p> <table border="1"> <tr> <td>Voltaje Nominal</td> <td>12 V</td> </tr> <tr> <td>Rated Current</td> <td>40A at 85°C</td> </tr> <tr> <td>Contact Form</td> <td>1 Form A / SPST N/O</td> </tr> </table>	Voltaje Nominal	12 V	Rated Current	40A at 85°C	Contact Form	1 Form A / SPST N/O
Voltaje Nominal	12 V								
Rated Current	40A at 85°C								
Contact Form	1 Form A / SPST N/O								

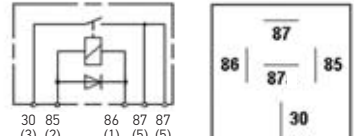
Product image / Dimensions	Features	Part Number	Technical Specifications
Mini Relay ISO 	<ul style="list-style-type: none"> • 24 V • SPST / Form A • Mounting Bracket • 20 Amp • Resistor Coil Suppression 	007957011 007957017	Minimum Order Quantity: 1 Pack - Minimum Order Quantity: 200
Mini Relay ISO 	<ul style="list-style-type: none"> • 12 V • SPST / Form A • Dust Cover • 40 Amp • Dual Output (2x Terminal 87) 	933791161 933791167	Minimum Order Quantity: 1 Pack - Minimum Order Quantity: 40
Mini Relay ISO 	<ul style="list-style-type: none"> • 24 V • SPST / Form A • Dust Cover • 20 Amp • Dual Output (2x Terminal 87) 	933791141	Minimum Order Quantity: 1
Mini Relay ISO 	<ul style="list-style-type: none"> • 12 V • SPST / Form A • Mounting Bracket • 40 Amp • Dual Output (2x Terminal 87) 	933791121 933791127	Minimum Order Quantity: 1 Pack - Minimum Order Quantity: 40
Mini Relay ISO 	<ul style="list-style-type: none"> • 12 V • SPST / Form A • Mounting Bracket • 40 Amp • Dual Output (2x Terminal 87) • Diode Coil Suppression 	933791151	Minimum Order Quantity: 1

Technical Data

Voltaje Nominal	24 V
Rated Current	20A at 85°C
Contact Form	1 Form A / SPST N/O

Technical Data

Voltaje Nominal	12 V
Rated Current	40A at 85°C
Contact Form	1 Form A / SPST N/O (2 x Terminal 87)

Technical Data

Voltaje Nominal	24 V
Rated Current	20A at 85°C
Contact Form	1 Form A / SPST N/O (2x Terminal 87)

Technical Data

Voltaje Nominal	12 V
Rated Current	40A at 85°C
Contact Form	1 Form A / SPST N/O (2 x Terminal 87)

Technical Data

Voltaje Nominal	12 V
Rated Current	40A at 85°C
Contact Form	1 Form A / SPST N/O (2x Terminal 87)

Product image / Dimensions	Features	Part Number	Technical Specifications
----------------------------	----------	-------------	--------------------------

Mini Relay ISO



- 24 V
- SPST / Form A
- Mounting Bracket
- 20 Amp
- Dual output (2 x Terminal 87)

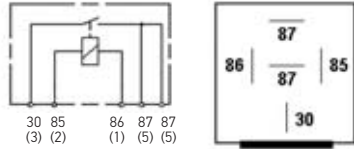

933791131	Minimum Order Quantity: 1
------------------	---------------------------

Technical Data

Voltaje Nominal	24 V
Rated Current	20A at 85°C
Contact Form	1 Form A / SPST N/O (2 x Terminal 87)

Mini Relay ISO



- 12 V
- SPDT / Form C
- 40 Amp
- Dust cover

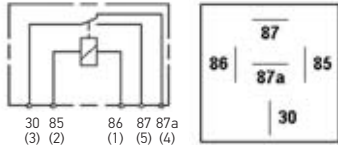

933332401	Minimum Order Quantity: 1
------------------	---------------------------

933332407	Pack - Minimum Order Quantity: 40
------------------	-----------------------------------

Technical Data

Voltaje Nominal	12 V
Rated Current	N/O 40A N/C 20A at 85°C
Contact Form	1 Form C / SPDT

Mini Relay ISO



- 24 V
- SPDT / Form C
- 20 Amp
- Dust cover

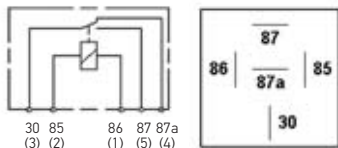

933332421	Minimum Order Quantity: 1
------------------	---------------------------

933332427	Minimum Order Quantity: 40
------------------	----------------------------

Technical Data

Voltaje Nominal	24 V
Rated Current	N/O 20A N/C 10A at 85°C
Contact Form	1 Form C / SPDT

Mini Relay ISO



- 12 V
- SPDT / Form C
- 40 Amp
- Mounting Bracket

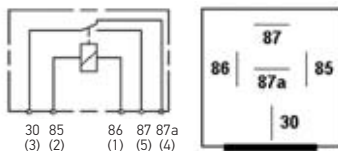

933332361	Minimum Order Quantity: 1
------------------	---------------------------

Technical Data

Voltaje Nominal	12 V
Rated Current	N/O 40A N/C 20A at 85°C
Contact Form	1 Form C / SPDT

Mini Relay ISO



- 24 V
- SPDT / Form C
- 20 Amp
- Mounting Bracket

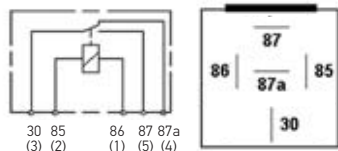









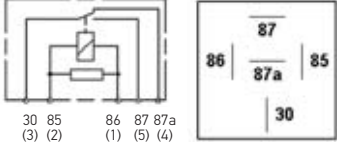

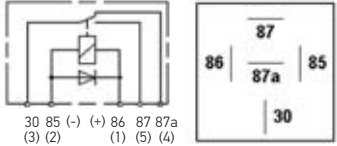

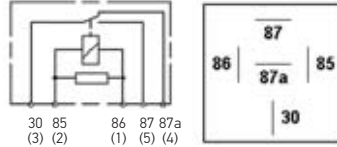

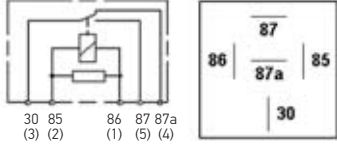

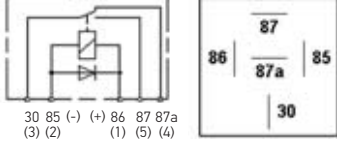

933332411	Minimum Order Quantity: 1
------------------	---------------------------

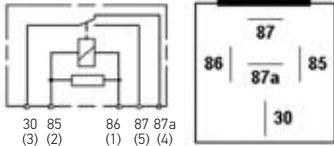

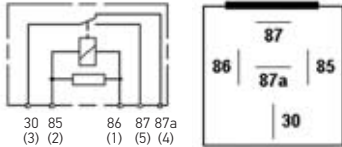

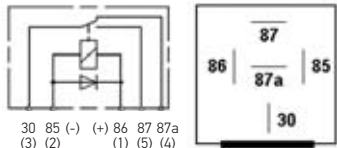

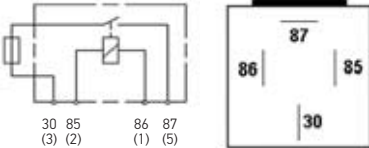

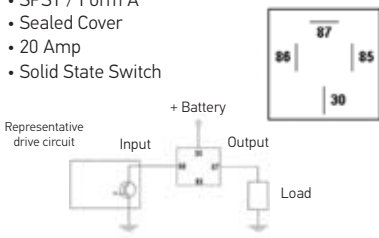
933332417	Pack - Minimum Order Quantity: 40
------------------	-----------------------------------

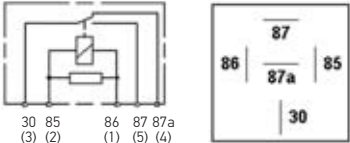

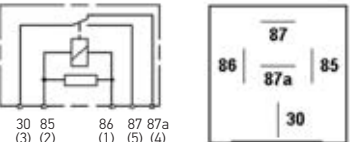

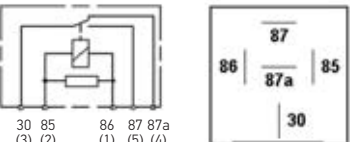

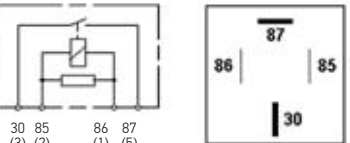

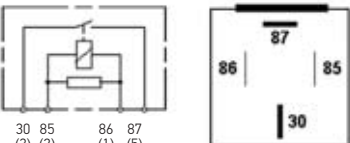
Technical Data

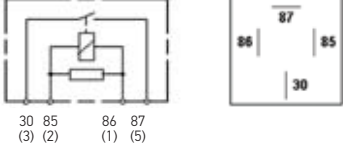
Voltaje Nominal	24 V
Rated Current	N/O 20A N/C 10A at 85°C
Contact Form	1 Form C / SPDT

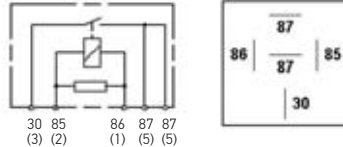
Product image / Dimensions	Features	Part Number	Technical Specifications
<p>Mini Relay ISO</p> 	<ul style="list-style-type: none"> • 12 V • SPDT / Form C • Dust cover • 40 Amp • Resistor Coil Suppression 	93332641	Minimum Order Quantity: 1
		Technical Data	
		Voltaje Nominal	12 V
		Rated Current	N/O 40A N/C 20A at 85°C
		Contact Form	1 Form C / SPDT
<p>Mini Relay ISO</p> 	<ul style="list-style-type: none"> • 12 V • SPDT / Form C • Dust cover • 40 Amp • Diode Coil Suppression • Dust Cover 	00779401	Minimum Order Quantity: 1
		00779407	Pack - Minimum Order Quantity: 200
		Technical Data	
		Voltaje Nominal	12 V
		Rated Current	N/O 40A N/C 20A at 85°C
		Contact Form	1 Form C / SPDT
<p>Mini Relay ISO</p> 	<ul style="list-style-type: none"> • 12 V • SPDT / Form C • Sealed cover • 40 Amp • Resistor Coil Suppression 	93168091	Minimum Order Quantity: 1
		93168017	Pack - Minimum Order Quantity: 360
		Technical Data	
		Voltaje Nominal	12 V
		Rated Current	N/O 40A N/C 20A at 85°C
		Contact Form	1 Form C / SPDT
<p>Mini Relay ISO</p> 	<ul style="list-style-type: none"> • 24 V • SPDT / Form C • Dust cover • 20 Amp • Resistor Coil Suppression 	93332611	Minimum Order Quantity: 1
		Technical Data	
		Voltaje Nominal	24 V
		Rated Current	N/O 20A N/C 10A at 85°C
		Contact Form	1 Form C / SPDT
<p>Mini Relay ISO</p> 	<ul style="list-style-type: none"> • 24 V • SPDT / Form C • Dust cover • 20 Amp • Diode Coil Suppression 	93332441	Minimum Order Quantity: 1
		93332447	Minimum Order Quantity: 40
		Technical Data	
		Voltaje Nominal	24 V
		Rated Current	N/O 20A N/C 10A at 85°C
		Contact Form	1 Form C / SPDT

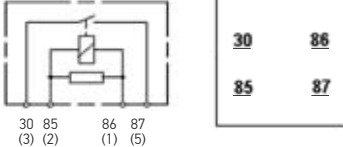
Product image / Dimensions	Features	Part Number	Technical Specifications						
<p>Mini Relay ISO</p> 	<ul style="list-style-type: none"> • 12 V • SPDT / Form C • Mounting Bracket • 40 Amp • Resistor Coil Suppression 	<p>933332661</p> <p>Technical Data</p>	<p>Minimum Order Quantity: 1</p> <table border="1"> <tr> <td>Voltaje Nominal</td> <td>12 V</td> </tr> <tr> <td>Rated Current</td> <td>N/O 40A N/C 20A at 85°C</td> </tr> <tr> <td>Contact Form</td> <td>1 Form C / SPDT</td> </tr> </table>	Voltaje Nominal	12 V	Rated Current	N/O 40A N/C 20A at 85°C	Contact Form	1 Form C / SPDT
Voltaje Nominal	12 V								
Rated Current	N/O 40A N/C 20A at 85°C								
Contact Form	1 Form C / SPDT								
<p>Mini Relay ISO</p> 	<ul style="list-style-type: none"> • 24 V • SPDT / Form C • Mounting Bracket • 20 Amp • Resistor Coil Suppression 	<p>933332701</p> <p>Technical Data</p>	<p>Minimum Order Quantity: 1</p> <table border="1"> <tr> <td>Voltaje Nominal</td> <td>24 V</td> </tr> <tr> <td>Rated Current</td> <td>N/O 20A N/C 10A at 85°C</td> </tr> <tr> <td>Contact Form</td> <td>1 Form C / SPDT</td> </tr> </table>	Voltaje Nominal	24 V	Rated Current	N/O 20A N/C 10A at 85°C	Contact Form	1 Form C / SPDT
Voltaje Nominal	24 V								
Rated Current	N/O 20A N/C 10A at 85°C								
Contact Form	1 Form C / SPDT								
<p>Mini Relay ISO</p> 	<ul style="list-style-type: none"> • 24 V • SPDT / Form C • Mounting Bracket • 20 Amp • Diode Coil Suppression 	<p>933332681</p> <p>Technical Data</p>	<p>Minimum Order Quantity: 1</p> <table border="1"> <tr> <td>Voltaje Nominal</td> <td>24 V</td> </tr> <tr> <td>Rated Current</td> <td>N/O 20A N/C 10A at 85°C</td> </tr> <tr> <td>Contact Form</td> <td>1 Form C / SPDT</td> </tr> </table>	Voltaje Nominal	24 V	Rated Current	N/O 20A N/C 10A at 85°C	Contact Form	1 Form C / SPDT
Voltaje Nominal	24 V								
Rated Current	N/O 20A N/C 10A at 85°C								
Contact Form	1 Form C / SPDT								
<p>Mini Relay ISO with built-in 25A fuse</p> 	<ul style="list-style-type: none"> • 12 V • SPST / Form A • Mounting Bracket • 30 Amp • With Built-in 25Amp Fuse 	<p>933332801</p> <p>Technical Data</p>	<p>Minimum Order Quantity: 1</p> <table border="1"> <tr> <td>Voltaje Nominal</td> <td>12 V</td> </tr> <tr> <td>Rated Current</td> <td>30A at 23°C</td> </tr> <tr> <td>Contact Form</td> <td>1 Form A / SPST N/O</td> </tr> </table>	Voltaje Nominal	12 V	Rated Current	30A at 23°C	Contact Form	1 Form A / SPST N/O
Voltaje Nominal	12 V								
Rated Current	30A at 23°C								
Contact Form	1 Form A / SPST N/O								
<p>Solid State Mini Relay ISO</p> 	<ul style="list-style-type: none"> • 12 V • SPST / Form A • Sealed Cover • 20 Amp • Solid State Switch 	<p>931774031</p> <p>931774037</p> <p>Technical Data</p>	<p>Minimum Order Quantity: 1</p> <p>Pack - Minimum Order Quantity: 189</p> <table border="1"> <tr> <td>Voltaje Nominal</td> <td>12 V</td> </tr> <tr> <td>Rated Current</td> <td>20A at 85°C</td> </tr> <tr> <td>Contact Form</td> <td>1 Form A / SPST N/O</td> </tr> </table>	Voltaje Nominal	12 V	Rated Current	20A at 85°C	Contact Form	1 Form A / SPST N/O
Voltaje Nominal	12 V								
Rated Current	20A at 85°C								
Contact Form	1 Form A / SPST N/O								

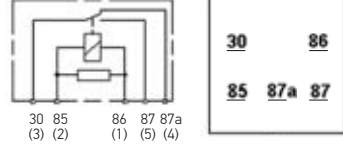
Product image / Dimensions	Features	Part Number	Technical Specifications						
<p>Mini Relay ISO</p> 	<ul style="list-style-type: none"> • 12 V • SPDT / Form C • 40 Amp • Resistor Coil Suppression • Weatherproof Cover 	<p>007794931</p> <p>007794327</p> <p>Technical Data</p> <table border="1"> <tr><td>Voltaje Nominal</td><td>12 V</td></tr> <tr><td>Rated Current</td><td>N/O 40A N/C 20A at 85°C</td></tr> <tr><td>Contact Form</td><td>1 Form C / SPDT</td></tr> </table> <p>Relay universal mounting bracket universal</p> <p>H84975001</p> <p>960975001</p>	Voltaje Nominal	12 V	Rated Current	N/O 40A N/C 20A at 85°C	Contact Form	1 Form C / SPDT	<p>Minimum Order Quantity: 1</p> <p>Pack - Minimum Order Quantity: 150</p>
Voltaje Nominal	12 V								
Rated Current	N/O 40A N/C 20A at 85°C								
Contact Form	1 Form C / SPDT								
<p>Mini Relay ISO</p> 	<ul style="list-style-type: none"> • 12 V • SPDT / Form C • Mounting Bracket • 40 Amp • Resistor Coil Suppression • Weatherproof Cover 	<p>007794911 (007794301)</p> <p>007794307</p> <p>Technical Data</p> <table border="1"> <tr><td>Voltaje Nominal</td><td>12 V</td></tr> <tr><td>Rated Current</td><td>N/O 40A N/C 20A at 85°C</td></tr> <tr><td>Contact Form</td><td>1 Form C / SPDT</td></tr> </table>	Voltaje Nominal	12 V	Rated Current	N/O 40A N/C 20A at 85°C	Contact Form	1 Form C / SPDT	<p>Minimum Order Quantity: 1</p> <p>Pack - Minimum Order Quantity: 150</p>
Voltaje Nominal	12 V								
Rated Current	N/O 40A N/C 20A at 85°C								
Contact Form	1 Form C / SPDT								
<p>Mini Relay ISO</p> 	<ul style="list-style-type: none"> • 24 V • SPDT / Form C • Mounting Bracket • 20 Amp • Resistor Coil Suppression • Weatherproof Cover 	<p>933332201</p> <p>933332207</p> <p>Technical Data</p> <table border="1"> <tr><td>Voltaje Nominal</td><td>24 V</td></tr> <tr><td>Rated Current</td><td>N/O 20A N/C 10A at 85°C</td></tr> <tr><td>Contact Form</td><td>1 Form C / SPDT</td></tr> </table>	Voltaje Nominal	24 V	Rated Current	N/O 20A N/C 10A at 85°C	Contact Form	1 Form C / SPDT	<p>Minimum Order Quantity: 1</p> <p>Pack - Minimum Order Quantity: 80</p>
Voltaje Nominal	24 V								
Rated Current	N/O 20A N/C 10A at 85°C								
Contact Form	1 Form C / SPDT								
<p>Mini ISO Power Relay</p> 	<ul style="list-style-type: none"> • 12 V • SPST / Form A • Dust cover • 50 Amp • Resistor Coil Suppression 	<p>933332531</p> <p>Technical Data</p> <table border="1"> <tr><td>Voltaje Nominal</td><td>12 V</td></tr> <tr><td>Rated Current</td><td>50A at 85°C</td></tr> <tr><td>Contact Form</td><td>1 Form A / SPST N/O</td></tr> </table>	Voltaje Nominal	12 V	Rated Current	50A at 85°C	Contact Form	1 Form A / SPST N/O	<p>Minimum Order Quantity: 1</p>
Voltaje Nominal	12 V								
Rated Current	50A at 85°C								
Contact Form	1 Form A / SPST N/O								
<p>Mini ISO Power Relay</p> 	<ul style="list-style-type: none"> • 12 V • SPST / Form A • Mounting Bracket • 50 Amp • Resistor Coil Suppression 	<p>933332521</p> <p>Technical Data</p> <table border="1"> <tr><td>Voltaje Nominal</td><td>12 V</td></tr> <tr><td>Rated Current</td><td>50A at 85°C</td></tr> <tr><td>Contact Form</td><td>1 Form A / SPST N/O</td></tr> </table>	Voltaje Nominal	12 V	Rated Current	50A at 85°C	Contact Form	1 Form A / SPST N/O	<p>Minimum Order Quantity: 1</p>
Voltaje Nominal	12 V								
Rated Current	50A at 85°C								
Contact Form	1 Form A / SPST N/O								

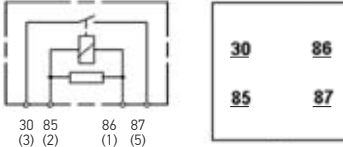
Product image / Dimensions	Features	Part Number	Technical Specifications
<p>Mini ISO Power relay</p> <p>NEW!</p> 	<ul style="list-style-type: none"> • 24 V • SPST / Form A • Power Design • 50 Amp • Mini ISO Footprint 	<p>965400131</p> <p>Technical Data</p>	<p>Minimum Order Quantity: 1</p> <p>Voltaje Nominal: 24 V</p> <p>Rated Current: 50A at 85°C</p> <p>Contact Form: 1 Form A / SPST N/O</p>
<p>Mini ISO Power relay</p> <p>NEW!</p> 	<ul style="list-style-type: none"> • 24 V • SPST / Form A • Dual Normally Open Contacts • 20 Amp • Mini ISO Footprint 	<p>965400141</p> <p>Technical Data</p>	<p>Minimum Order Quantity: 1</p> <p>Voltaje Nominal: 24 V</p> <p>Rated Current: 20A at 85°C</p> <p>Contact Form: 1 Form A / SPST N/O</p>
<p>Micro Relay 280</p> 	<ul style="list-style-type: none"> • 12 V • SPST / Form A • 30 Amp • Resistor Coil Suppression • Dust Cover 	<p>933332571</p> <p>Technical Data</p>	<p>Minimum Order Quantity: 1</p> <p>Voltaje Nominal: 12 V</p> <p>Rated Current: 30A at 125°C</p> <p>Contact Form: 1 Form A / SPST N/O</p>
<p>Micro Relay 280</p> 	<ul style="list-style-type: none"> • 12 V • SPDT / Form C • 30 Amp • Resistor Coil Suppression • Dust Cover 	<p>933332581</p> <p>Technical Data</p>	<p>Minimum Order Quantity: 1</p> <p>Voltaje Nominal: 12 V</p> <p>Rated Current: N/O 30A N/C 20A at 125°C</p> <p>Contact Form: 1 Form C / SPDT</p>
<p>Micro Relay 280</p> 	<ul style="list-style-type: none"> • 12 V • SPST / Form A • 35 Amp • Resistor Coil Suppression • Dust Cover 	<p>933332591</p> <p>Technical Data</p>	<p>Minimum Order Quantity: 1</p> <p>Voltaje Nominal: 12 V</p> <p>Rated Current: 35A at 125°C</p> <p>Contact Form: 1 Form A / SPST N/O</p>

Product image / Dimensions	Features	Part Number	Technical Specifications
----------------------------	----------	-------------	--------------------------

Micro Relay 280

- 12 V
- SPDT / Form C
- 35 Amp
- Resistor Coil Suppression
- Dust Cover

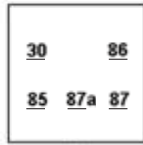
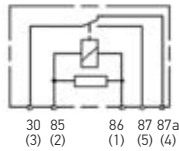

93332601	Minimum Order Quantity: 1
-----------------	---------------------------

Technical Data

Voltaje Nominal	12 V
Rated Current	N/O 35A N/C 20A at 125°C
Contact Form	1 Form C / SPDT

Mini Relay 280

- 12 V
- SPDT / Form C
- Mounting Bracket
- 35 Amp
- Weatherproof Cover
- Resistor Coil Suppression

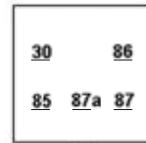
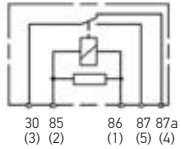
With mounting bracket

931410082 (H41410081)	Minimum Order Quantity: 1
------------------------------	---------------------------

931410087	Pack - Minimum Order Quantity: 80
------------------	-----------------------------------

Without mounting bracket

931410901 (H41410051)	Minimum Order Quantity: 1
------------------------------	---------------------------

931410057	Pack - Minimum Order Quantity: 80
------------------	-----------------------------------

Technical Data

Voltaje Nominal	12 V
Rated Current	N/O 35A N/C 20A at 85°C
Contact Form	1 Form C / SPDT

Relay universal mounting bracket universal

358112031	Quantity: 10 pieces
------------------	---------------------

931489901	Quantity: 100 pieces
------------------	----------------------

Mini Relay ISO Heavy Duty

- 12 V
- SPST / Form A
- 60 Amp
- Mounting Bracket

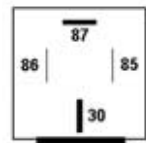
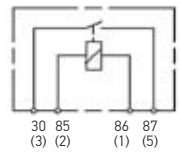

003437081	Minimum Order Quantity: 1
------------------	---------------------------

003437087	Pack - Minimum Order Quantity: 120
------------------	------------------------------------

Technical Data

Voltaje Nominal	12 V
Rated Current	60A at 85°C
Contact Form	1 Form A / SPST N/O

Mini Relay ISO Heavy Duty

- 24 V
- SPST / Form A
- 60 Amp
- Mounting Bracket

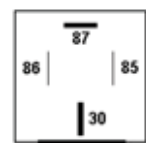
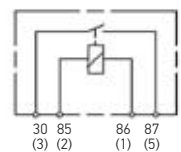

003437092 (H41437091)	Minimum Order Quantity: 1
------------------------------	---------------------------

003437097	Pack - Minimum Order Quantity: 120
------------------	------------------------------------

Technical Data

Voltaje Nominal	24 V
Rated Current	60A at 85°C
Contact Form	1 Form A / SPST N/O

Product image / Dimensions	Features	Part Number	Technical Specifications
----------------------------	----------	-------------	--------------------------

Flasher
2 Terminals

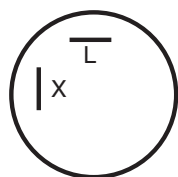

Common Pin Designations

Terminal	Description
49/X	Flashing input (+)
49a/L	Flasher output (+) to lamps or indicator switch
30b	Flasher input (+) from hazard switch
31	Ground (-)
C/C1/CP/P	Vehicle pilot lamp output (+)
C2	1st trailer pilot lamp output (+)
C3	2nd trailer pilot lamp output (+)

Part No.	Description
961553151	2 Pin Flasher Unit - 12 V (Single)
961553157	2 Pin Flasher Unit - 12 V (Bulk 50 Pieces)

High capacity flasher with 6 bulb maximum.
 Suitable for hazard warning applications.
 Max Load: 12 lamps / 25 Amps (Hazard)
 Bracket: H84677001

Flasher
3 Terminals

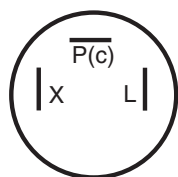

Part No.	Description
961553161	3 Pin Flasher Unit - 12 V (Single)
961553167	3 Pin Flasher Unit - 12 V (Bulk 50 Pieces)

High capacity flasher with 6 bulb maximum.
 Suitable for hazard warning applications.
 Max Load: 12 lamps / 25 Amps (Hazard)
 Bracket: H84677001

961553171	3 Pin Flasher Unit - 24 V (Single)
------------------	------------------------------------

High capacity flasher with 5 bulb maximum.
 Suitable for hazard warning applications.
 Max Load: 10 lamps SAE # 1683 (Hazard)
 Bracket: H84677001

Flasher
3 Terminals

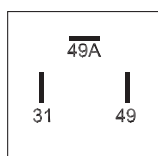

931675911 (H42675031)	3 Pin Flasher Unit - 12 V (Individual)
931675037	3 Pin Flasher Unit - 12 V (Bulk 210 pieces)

High capacity flasher with 8 bulb maximum
 Suitable for hazard warning applications
 Max. Load: 16 Bulbs (Hazard)

Product image / Dimensions	Features	Part Number	Technical Specifications
----------------------------	----------	-------------	--------------------------

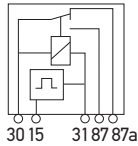
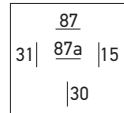
Ajustable Control Time Delay Unit

996152131

Adjustable Control Time Delay Unit - Delay on Release - 12 V

996152141

Adjustable Control Time Delay Unit - Delay on Release - 24 V

996152151

Adjustable Control Time Delay Unit - Delay on Operate - 12 V

996152161

Adjustable Control Time Delay Unit - Delay on Operate - 24 V

Designed for a wide range of applications requiring a time delayed switch on or off.

Time Delay Range: 0 to 900 seconds

S1	S2	T(s)
Off	Off	100...900
On	On	14...110
On	Off	2.5...14
Off	On	0...2.5

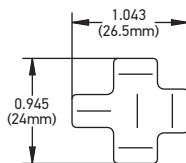
Relay Socket - Mini ISO

5 terminals, printed circuit board

358112171 (H84989031)

Quantity: 1 piece

358112111 (H84989037)

Quantity: 50 pieces

358112321 (U84989037)

Quantity: 2500 pieces

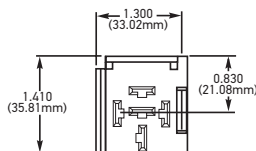
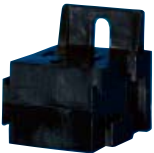
Relay Socket - Mini ISO

Bracket mount, connector block

358112141 (H84989011)

Quantity: 1 piece

358112131 (H84989017)

Quantity: 50 pieces

358112301 (U84989017)

Quantity: 1000 pieces

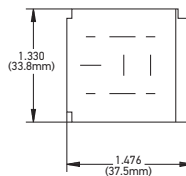
Relay Socket - Mini ISO

5 or 9 terminals, bracket mount, connector block

003526001

Quantity: 5 pieces

003526002

Quantity: 50 pieces

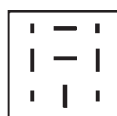
Relay Socket - 9 pins

SAE relay socket, 9 pins

Suitable for 2 flat plugs of 6.3 mm, 2 of 9.5 mm and 4 of 2.8 mm.

183161002

Quantity: 5 pieces

Product image / Dimensions	Features	Part Number	Technical Specifications
----------------------------	----------	-------------	--------------------------

Relay Socket - Micro ISO

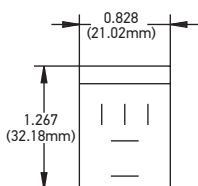

5 or 9 terminals, bracket mount

358112161 (H84702001)	Quantity: 1 piece
358112091 (H84702007)	Quantity: 50 pieces
358112241 (U84702007)	Quantity: 2250 pieces

Relay socket - Mini ISO

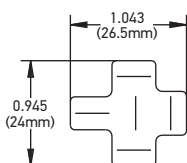

Wire harness connector

358112181 (H84989021)	Quantity: 1 piece
358112121 (H84989027)	Quantity: 50 pieces
358112311 (U84989027)	Quantity: 1000 pieces

Relay socket - Mini ISO

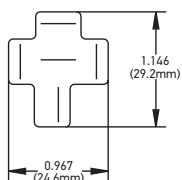

High current (50A), wire harness connector

358112191 (H84703001)	Quantity: 1 piece
358112151 (H84703007)	Quantity: 50 pieces
358112251 (U84703007)	Quantity: 700 pieces

Relay Socket - Mini ISO



Weatherproof relay connector kit

358112101 (H84709011)	Quantity: 1 piece
------------------------------	-------------------

Relay Socket - Mini ISO

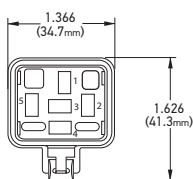

Weatherproof relay connector with 12" leads

358114921 (H84709001)	Quantity: 1 pieces
------------------------------	--------------------

Relay Socket - Mini 280

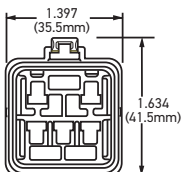

Weatherproof relay connector with 12" leads

358114931 (H84708001)	Quantity: 1 pieces
------------------------------	--------------------

Product image / Dimensions	Features	Part Number	Technical Specifications
----------------------------	----------	-------------	--------------------------

Female Terminals

Female Terminals with Catch

Part No.	AWG wire	Blade size	Package Quantity
172616902 (H84991151)	10 - 12	.375" (9.5mm)	50
172615007	10 - 12	.375" (9.5mm)	2,000
172615902 (H84991141)	6 - 10	.375" (9.5mm)	50
172616007	6 - 10	.375" (9.5mm)	1,800
701235033	14 - 16	.250" (6.3mm)	100
701235034	14 - 16	.250" (6.3mm)	1,500
733815003	18	.188" (4.8mm)	100
744817003	14 - 20	.110" (2.8mm)	100

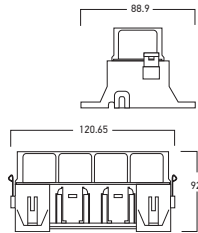
Relay Box - Mini ISO

4-Gang Mini ISO Relay Box (Single)

- Splashproof relay boxed
- Snap-fit clear plastic cover
- O-Ring sealed, holds four plug-in type relays
- Removable mounting feet
- Multiple boxes can be snapped together

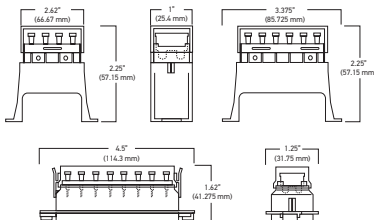
358112221 (H84988001)	Relay Box Mini ISO, 4-gang
358112211 (H84988011)	Relay Box Mini ISO, 7-gang

Fuse Box

Bottom tap connections



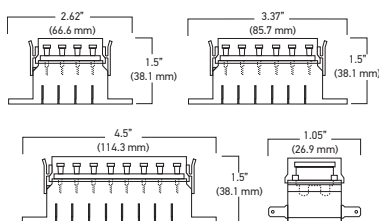



- Splashproof fuse boxed
- Snap-fit clear plastic cover
- O-Ring sealed
- Max load: 20a per circuit
- Fuses not included

358115881 (H84960061)	Fuse boxed - 4 terminals
358115901 (H84960081)	Fuse boxed - 6 terminals
358115801 (H84960101)	Fuse boxed - 8 terminals

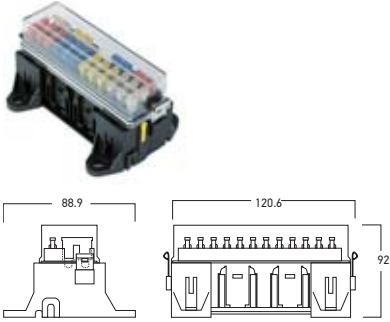
Fuse Box

Side connections

- Splashproof Fuse Box
- Snap-Fit Clear Plastic Cover
- O-ring Sealed
- Max Load: 20A per circuit
- Fuses not included

358115891 (H84960071)	Fuse boxed - 4 terminals, lateral connection
358115781 (H84960091)	Fuse boxed - 6 terminals, lateral connection
358115791 (H84960111)	Fuse boxed - 8 terminals, lateral connection

Product image / Dimensions	Features	Part Number	Technical Specifications					
<p>Fuse boxed</p> 	<p>16 Gang fuse boxed - Bottom tab connections</p> <p>Splashproof Fuse Box Snap-Fit Clear Plastic Cover O-ring Sealed Removable Mounting Feet Boxes Can Be Snapped Together for 32,48 Fuses etc. Max Load: 20A per circuit Fuses not included</p>	<table border="1"> <tr> <td>358115871 (H84960051)</td> <td colspan="2">Fuse Box - 16 terminals, lateral connection</td> </tr> </table>	358115871 (H84960051)	Fuse Box - 16 terminals, lateral connection				
358115871 (H84960051)	Fuse Box - 16 terminals, lateral connection							
<p>Fuse holder MAXI</p>  <p>Fuse not included</p>	<p>Splash proof For MAXI fuses 8 AWG wire 32 cm in length</p>	<table border="1"> <tr> <td>358129911</td> <td>MAXI Fuse holder</td> <td>Quantity: 1 piece</td> </tr> <tr> <td>358129902</td> <td>MAXI Fuse holder</td> <td>Quantity: 5 pieces</td> </tr> </table>	358129911	MAXI Fuse holder	Quantity: 1 piece	358129902	MAXI Fuse holder	Quantity: 5 pieces
358129911	MAXI Fuse holder	Quantity: 1 piece						
358129902	MAXI Fuse holder	Quantity: 5 pieces						
<p>Fuse holder STANDARD</p> 	<p>Splash proof For STANDARD fuses 12 AWG wire 32 cm in length</p>	<table border="1"> <tr> <td>358129931</td> <td>STANDARD Fuse holder</td> <td>Quantity: 1 piece</td> </tr> <tr> <td>358129921</td> <td>STANDARD Fuse holder</td> <td>Quantity: 10 pieces</td> </tr> </table>	358129931	STANDARD Fuse holder	Quantity: 1 piece	358129921	STANDARD Fuse holder	Quantity: 10 pieces
358129931	STANDARD Fuse holder	Quantity: 1 piece						
358129921	STANDARD Fuse holder	Quantity: 10 pieces						
<p>MINI Fuse assortment</p> 	<p>Assortment of fast acting fuses. It contains: 20 pieces of each of the following fuses: 5A, 7.5A, 10A, 15A, 20A, 25A, 30A</p> <p>Technical Data</p> <p>Voltage Rating: 58 VCD or less Interrupting Rating: 1000A @ 58 VCD Operating Temperature Range: -40° C a + 125° C Complies: SAE J2077 / JASO D612 / ISO 8820-3 / ROHS</p>	<table border="1"> <tr> <td>358129961</td> <td>MINI Fuse assortment</td> <td>Quantity: 140 pieces</td> </tr> </table>	358129961	MINI Fuse assortment	Quantity: 140 pieces			
358129961	MINI Fuse assortment	Quantity: 140 pieces						
<p>STANDARD Fuse assortment</p> 	<p>Assortment of fast acting fuses. It contains: 10 pieces of each of the following fuses: 5A, 7.5A, 25A, 30A 20 pieces of each of the following fuses: 10A, 15A, 20A</p> <p>Technical Data</p> <p>Voltage Rating: 58 VCD or less Interrupting Rating: 1000A @ 58 VCD Operating Temperature Range: -40° C a + 125° C Complies: SAE J1284 / JASOD612 / ISO 8820-3 / ROHS</p>	<table border="1"> <tr> <td>358129991</td> <td>STANDARD fuse assortment</td> <td>Quantity: 100 pieces</td> </tr> </table>	358129991	STANDARD fuse assortment	Quantity: 100 pieces			
358129991	STANDARD fuse assortment	Quantity: 100 pieces						
<p>MAXI Fuse assortment</p> 	<p>Assortment of slow-blow fuses. It contains: 5 pieces of each of the following fuses: 70A, 80A 10 pieces of each of the following fuses: 20A, 30A, 40A, 50A, 60A</p> <p>Technical Data</p> <p>Voltage Rating: 58 VCD or less Interrupting Rating: 1000A @ 58 VCD Operating Temperature Range: -40° C a + 125° C Complies: SAE J1888 / JASO D612 / ISO 8820-3 / ROHS</p>	<table border="1"> <tr> <td>358129971</td> <td>MAXI fuse assortment</td> <td>Quantity: 60 pieces</td> </tr> </table>	358129971	MAXI fuse assortment	Quantity: 60 pieces			
358129971	MAXI fuse assortment	Quantity: 60 pieces						

Product image / Dimensions	Features	Part Number	Technical Specifications
----------------------------	----------	-------------	--------------------------

**MINI LP fuses
(low profile)**

Fast Acting

Voltage Rating: 58 VCD or less
 Interrupting Rating: 1000A @ 58 VCD
 Operating Temperature Range: -40° C a + 125° C
 Complies: JASO D612 / ISO 8820-9 / ROHS

358129003	MINI LP fuse, boxed, 2A: gray	Quantity: 200 pieces
358129013	MINI LP fuse, boxed, 3A: violet	Quantity: 200 pieces
358129023	MINI LP fuse, boxed, 4A: pink	Quantity: 200 pieces
358129033	MINI LP fuse, boxed, 5A: beige	Quantity: 200 pieces
358129043	MINI LP fuse, boxed, 7.5A: brown	Quantity: 200 pieces
358129053	MINI LP fuse, boxed, 10A: red	Quantity: 200 pieces
358129063	MINI LP fuse, boxed, 15A: blue	Quantity: 200 pieces
358129073	MINI LP fuse, boxed, 20A: yellow	Quantity: 200 pieces
358129083	MINI LP fuse, boxed, 25A: white	Quantity: 200 pieces
358129093	MINI LP fuse, boxed, 30A: green	Quantity: 200 pieces

MINI fuses

Fast Acting

Technical data:

Voltage Rating: 58 VCD or less
 Interrupting Rating: 1000A @ 58 VCD
 Operating Temperature Range: -40° C a + 125° C
 Complies: SAE J2077 / JASO D612 / ISO 8820-3 / ROHS

358129103	MINI fuse, boxed, 2A: gray	Quantity: 200 pieces
358129113	MINI fuse, boxed, 3A: violet	Quantity: 200 pieces
358129123	MINI fuse, boxed, 4A: pink	Quantity: 200 pieces
358129133	MINI fuse, boxed, 5A: beige	Quantity: 200 pieces
358129143	MINI fuse, boxed, 7.5A: brown	Quantity: 200 pieces
358129153	MINI fuse, boxed, 10A: red	Quantity: 200 pieces
358129163	MINI fuse, boxed, 15A: blue	Quantity: 200 pieces
358129173	MINI fuse, boxed, 20A: yellow	Quantity: 200 pieces
358129183	MINI fuse, boxed, 25A: white	Quantity: 200 pieces
358129193	MINI fuse, boxed, 30A: green	Quantity: 200 pieces
358129203	MINI fuse, boxed, 35A: dark green	Quantity: 200 pieces

STANDARD fuses

Fast Acting

Technical data:

Voltage Rating: 58 VCD or less
 Interrupting Rating: 1000A @ 58 VCD
 Operating Temperature Range: -40° C a + 125° C
 Complies: SAE J1284 / JASOD612 / ISO 8820-3 / ROHS

358129213	STANDARD fuse, boxed, 1A: black	Quantity: 100 pieces
358129223	STANDARD fuse, boxed, 2A: gray	Quantity: 100 pieces
358129233	STANDARD fuse, boxed, 3A: violet	Quantity: 100 pieces
358129243	STANDARD fuse, boxed, 4A: pink	Quantity: 100 pieces
358129253	STANDARD fuse, boxed, 5A: beige	Quantity: 100 pieces
358129263	STANDARD fuse, boxed, 7.5A: brown	Quantity: 100 pieces
358129273	STANDARD fuse, boxed, 10A: red	Quantity: 100 pieces
358129283	STANDARD fuse, boxed, 15A: blue	Quantity: 100 pieces
358129293	STANDARD fuse, boxed, 20A: yellow	Quantity: 100 pieces
358129303	STANDARD fuse, boxed, 25A: white	Quantity: 100 pieces
358129313	STANDARD fuse, boxed, 30A: green	Quantity: 100 pieces
358129323	STANDARD fuse, boxed, 35A: dark green	Quantity: 100 pieces
358129333	STANDARD fuse, boxed, 40A: orange	Quantity: 100 pieces





MAXI fuses

Slow-blow

Technical data:

Voltage Rating: 58 VCD or less
 Interrupting Rating: 1000A @ 58 VCD
 Operating Temperature Range: -40° C a + 125° C
 Complies: SAE J1888 / JASO D612 / ISO 8820-3 / ROHS

358129343	MAXI fuse, boxed, 20A: yellow	Quantity: 20 pieces
358129353	MAXI fuse, boxed, 30A: green	Quantity: 20 pieces
358129363	MAXI fuse, boxed, 40A: orange	Quantity: 20 pieces
358129373	MAXI fuse, boxed, 50A: red	Quantity: 20 pieces
358129383	MAXI fuse, boxed, 60A: blue	Quantity: 20 pieces
358129393	MAXI fuse, boxed, 70A: brown	Quantity: 20 pieces
358129403	MAXI fuse, boxed, 80A: white	Quantity: 20 pieces

Product image / Dimensions	Features	Part Number	Technical Specifications
MINI LP FUSES Low profile 		358129002	MINI LP fuse, boxed, 2A: gray Quantity: 10 pieces
		358129012	MINI LP fuse, boxed, 3A: violet Quantity: 10 pieces
		358129022	MINI LP fuse, boxed, 4A: pink Quantity: 10 pieces
		358129032	MINI LP fuse, boxed, 5A: beige Quantity: 10 pieces
		358129042	MINI LP fuse, boxed, 7.5A: brown Quantity: 10 pieces
		358129052	MINI LP fuse, boxed, 10A: red Quantity: 10 pieces
		358129062	MINI LP fuse, boxed, 15A: blue Quantity: 10 pieces
		358129072	MINI LP fuse, boxed, 20A: yellow Quantity: 10 pieces
		358129082	MINI LP fuse, boxed, 25A: white Quantity: 10 pieces
		358129092	MINI LP fuse, boxed, 30A: green Quantity: 10 pieces
	358129941	Assortment of fuses, includes: 1 piece of each fuse: 5A, 7.5A, 25A, 30A 2 pieces of each fuse: 10A, 15A, 20A Quantity: 10 pieces	
MINI FUSES 		358129102	MINI fuse, boxed, 2A: gray Quantity: 10 pieces
		358129112	MINI fuse, boxed, 3A: violet Quantity: 10 pieces
		358129122	MINI fuse, boxed, 4A: pink Quantity: 10 pieces
		358129132	MINI fuse, boxed, 5A: beige Quantity: 10 pieces
		358129142	MINI fuse, boxed, 7.5A: brown Quantity: 10 pieces
		358129152	MINI fuse, boxed, 10A: red Quantity: 10 pieces
		358129162	MINI fuse, boxed, 15A: blue Quantity: 10 pieces
		358129172	MINI fuse, boxed, 20A: yellow Quantity: 10 pieces
		358129182	MINI fuse, boxed, 25A: white Quantity: 10 pieces
		358129192	MINI fuse, boxed, 30A: green Quantity: 10 pieces
	358129202	MINI fuse, boxed, 35A: dark green Quantity: 10 pieces	
	358129951	Assortment of fuses, includes: 1 piece of each fuse: 5A, 7.5A, 25A, 30A 2 pieces of each fuse: 10A, 15A, 20A Quantity: 10 pieces	
STANDARD FUSES 		358129212	STANDARD fuse, boxed, 1A: black Quantity: 10 pieces
		358129222	STANDARD fuse, boxed, 2A: gray Quantity: 10 pieces
		358129232	STANDARD fuse, boxed, 3A: violet Quantity: 10 pieces
		358129242	STANDARD fuse, boxed, 4A: pink Quantity: 10 pieces
		358129252	STANDARD fuse, boxed, 5A: beige Quantity: 10 pieces
		358129262	STANDARD fuse, boxed, 7.5A: brown Quantity: 10 pieces
		358129272	STANDARD fuse, boxed, 10A: red Quantity: 10 pieces
		358129282	STANDARD fuse, boxed, 15A: blue Quantity: 10 pieces
		358129292	STANDARD fuse, boxed, 20A: yellow Quantity: 10 pieces
		358129302	STANDARD fuse, boxed, 25A: white Quantity: 10 pieces
	358129312	STANDARD fuse, boxed, 30A: green Quantity: 10 pieces	
	358129322	STANDARD fuse, boxed, 35A: dark green Quantity: 10 pieces	
	358129332	STANDARD fuse, boxed, 40A: orange Quantity: 10 pieces	
	358129981	Assortment of fuses, includes: 1 piece of each fuse: 5A, 7.5A, 25A, 30A 2 pieces of each fuse: 10A, 15A, 20A Quantity: 10 pieces	
MAXI FUSES 		358129341	MAXI fuse, boxed 20A: yellow Quantity: 1 piece
		358129351	MAXI fuse, boxed 30A: green Quantity: 1 piece
		358129361	MAXI fuse, boxed 40A: orange Quantity: 1 piece
		358129371	MAXI fuse, boxed 50A: red Quantity: 1 piece
		358129381	MAXI fuse, boxed 60A: blue Quantity: 1 piece
		358129391	MAXI fuse, boxed 70A: brown Quantity: 1 piece
	358129401	MAXI fuse, boxed 80A: white Quantity: 1 piece	

Product image / Dimensions	Features	Part Number	Technical Specifications
----------------------------	----------	-------------	--------------------------

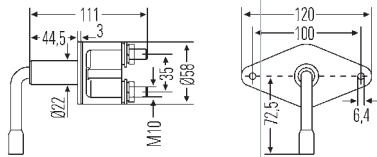
Battery main switch

Part Number	001559001
Description	Battery main switch
Rated current	100 A
Capacity at 24 V.	max 2500 A/10 seconds
Connection	M10
Mounting type	Screw
DIN / ISO standard	40050
Number of connectors	2 (with one screw for each terminal, includes 1 nut per screw)
Control Type	Knob twist control
Combination switch function	Closing

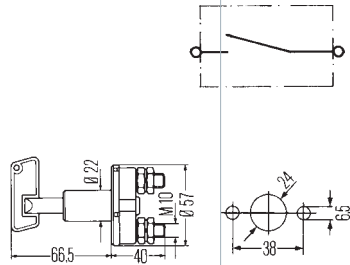

Part Number	002843002
Description	Battery main switch
Rated current	50 A
Capacity at 24 V.	max 1000 A/10 seconds
Connection	M10
Mounting type	Screw
DIN / ISO standard	40050-IPX4 front; IPX2 back
Number of connectors	2 (with one screw for each terminal, includes 1 nut per screw)
Control Type	Knob twist control
Combination switch function	Closing

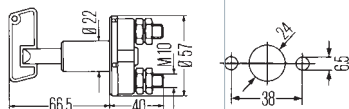

Part Number	002843017
Description	Battery main switch
Rated current	100 A
Capacity at 24 V.	max 1000 A/10 seconds
Connection	M10
Mounting type	Screw
DIN / ISO standard	40050-IPX4 front; IPX2 back
Number of connectors	2 (with one screw for each terminal, includes 1 nut per screw)
Control Type	Knob twist control
Combination switch function	Closing

EXPERTISE IN ELECTRONICS FOR ORIGINAL EQUIPMENT

Wherever products have to be controlled, measured, regulated or monitored, HELLA components have been tested a million times, under extreme conditions. We work based on the needs of customers and produce the highest quality electronic components for agricultural vehicles, construction machinery, trucks, trailers, city buses, municipal vehicles and vehicles with special bodies, emergency vehicles, campers, motorcycles and cars sports.

We offer a wide range of electronic components in the three fields: in energy management, powertrain and other engine components, which must meet the most demanding operating demands in commercial and passenger vehicles.

HELLA electronic components for all vehicles, operate 24 hours under extremely difficult conditions, ensuring optimal and reliable performance.

The full range of HELLA Electronics



HELLA SENSORS: Up to 30% of the value of a new equipped car is due to its electrical system and, even more, to its electronic systems. That is not a matter of fashion, but the result of consumer demand to increase safety, convenience, information and entertainment while driving. However, any component installed in a car may one day fail. 52% of all failures are already caused by defective software or defective electronics.

HELLA sensors perform complex operations with components such as: speed sensors, flow meters, detonation sensors, manifold pressure / pressure sensors, coolant / oil / air temperature sensors, oxygen sensors (lambda), oil level sensors / coolant, throttle position and throttle valve position - among other components, ensuring optimal operation, at all times.

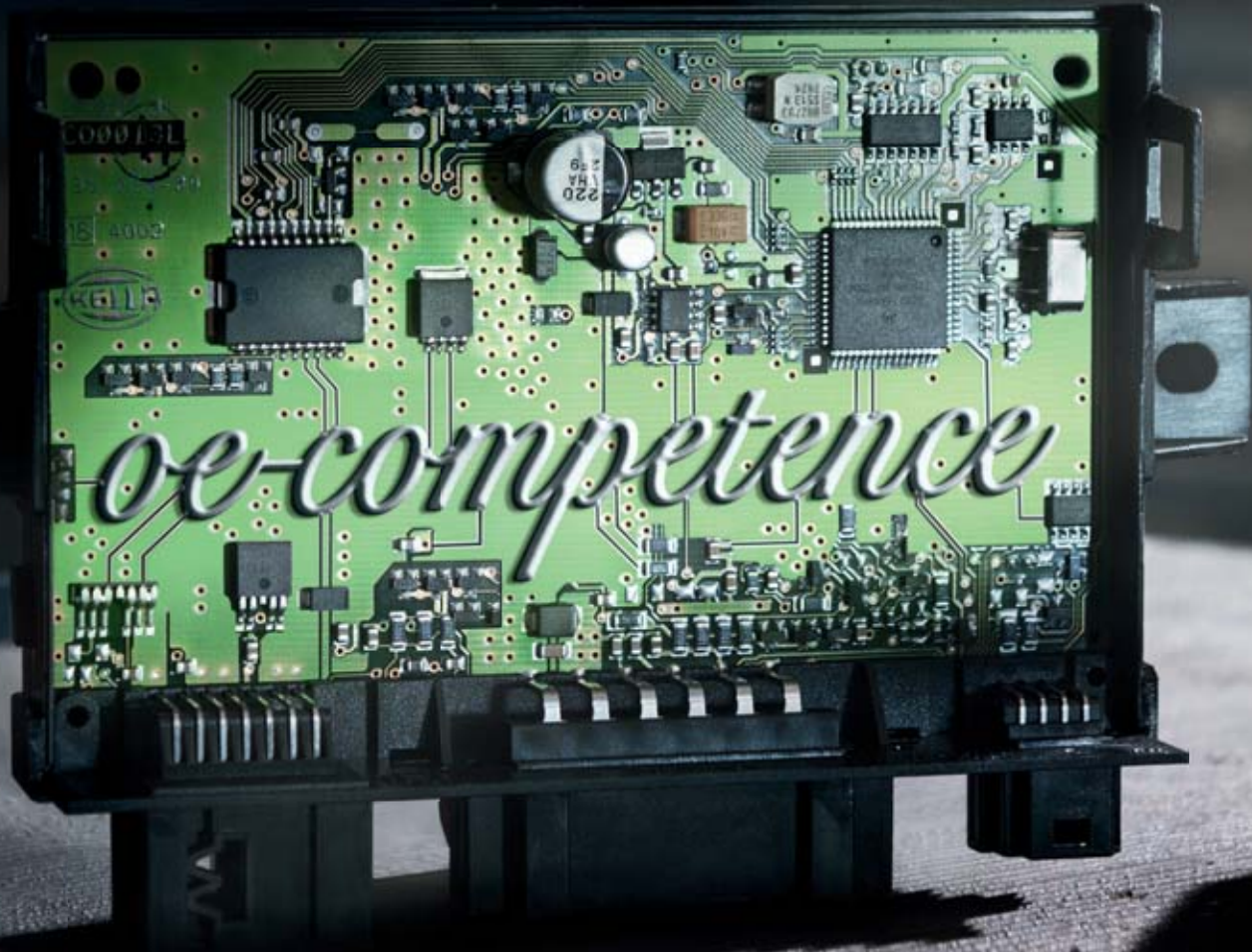

UPDATED!

HELLA ELECTRONICS VEHICLE SPECIFIC APPLICATIONS

For Hella Electronic vehicle specific applications products, consult our website for detailed information:

<https://hella.mypartfinder.com/>

Indispensable tool for today's online web search.



ELECTRONICS AND BRAKE SYSTEMS

HELLA brings original equipment expertise.

Independent workshops can take advantage of HELLA's extensive experience in original equipment and a comprehensive range of electronics and brake system solutions.

EFFICIENCY

 Air Mass Sensor	 High-pressure Fuel Pump	 MAP Sensor	 EGR Valve	 Turbo Charger Actuator	 Circulating Pump	
 Intelligent Battery Sensor (IBS)	 Temperature Sensor	 Speed Sensor	 Exhaust Gas Pressure Sensor	 Additional Water Cooling Pump	 Preglow Relay	
 Fuel Pump	 High Temperature Sensor	 Reverse Light Switch				
 Oxygen Sensor	 Accelerator Pedal					
 Fuel Pump Relay	 Voltage Reducer					
 Electronic Throttle Valve Unit	 Knock Sensor	 Oil Level Sensor				
 Oil Pressure Switch	 Temperature Switch	 Glow Plug	 Throttle Position Sensor	 Control Valve, Camshaft Phasing	 Alternator	
 Ignition Module	 Ignition Coil	 Spark Plug	 Coolant Thermostat	 Idle Speed Control	 Starter	 NOx Sensor

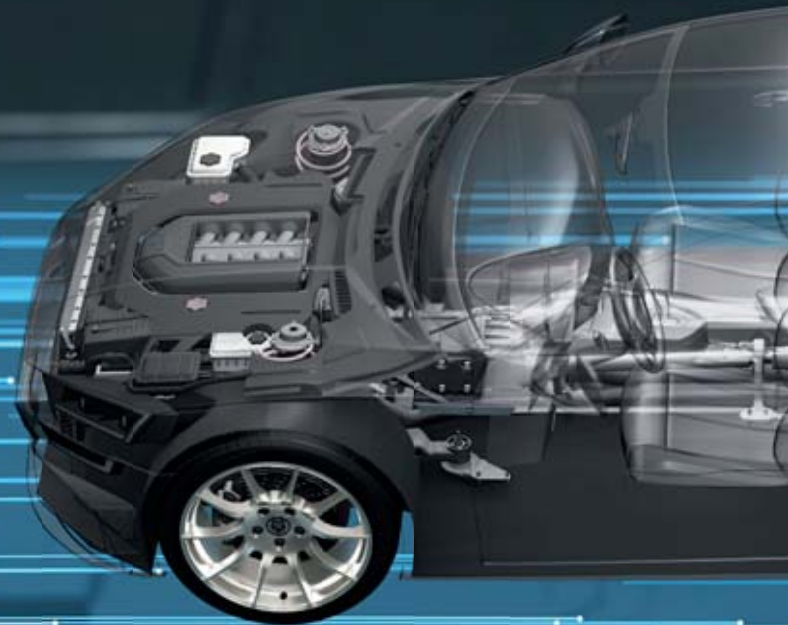

BRAKES



Brake Rotors



Brake Pads
Low-Met, Ceramic,
Semi-Metallic



Calipers



Brake Fluid



Wear Sensor and
Accessories

SAFETY



Blind Spot Assistant



Rain-Light Sensor



Steering Angle
Sensor



Radar
CAPA Tier 1 Verification



Wheel Speed Sensor



Central Locking



Stoplight / Clutch Pedal
Switch



Wiper Control Unit



Vacuum Pump



Horn



Washer Pump



Flasher Unit

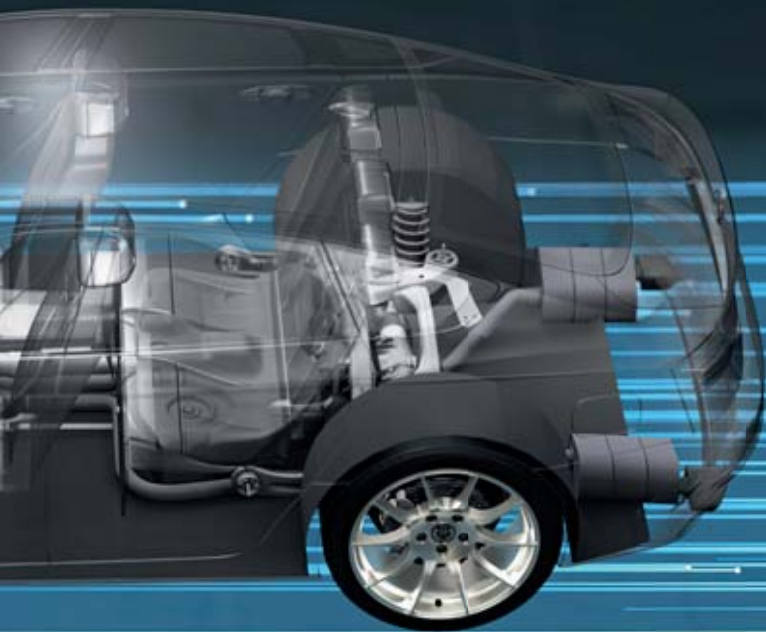

COMFORT



Hydraulic Steering
Pump



Trailer Tow Module

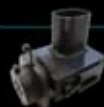

Air Quality Sensor



Park Distance Control



Mini Relay



More information you
can find here

www.helix.com/ve



EMISSIONS

Extremely reliable due to its
robust design



PEDAL SENSORS

The pedal sensors transmit the driver's intention to the engine management system. With the principle of wear-free measurement of HELLA CIPOS® sensors and their low mechanical wear, they are ideal for driver's cabins in agricultural vehicles and construction machinery. They are available as suspended or floor mounted versions.

- Accurate position measurement with HELLA technology CIPOS® ($\pm 2\%$ accuracy) or a potentiometer
- Extensive application experience thanks to the production experience acquired since 1996
- Mechanical design variations according to the customer specifications

VACUUM PUMPS

Until recently, most brake superchargers used the vacuum generated by the air intake section of the internal combustion engine. However, with the introduction of new engine technologies (for example, hybrid vehicles, size reduction) or under specific operating conditions (for example, during the cold start / warm-up phase, driving at extreme altitudes or when using the system of air conditioning), the vacuum produced by the engine is no longer enough. Electric vacuum pumps are used to ensure reliable operation of the brake booster

HELLA's electronic product range includes four different types of vacuum pumps for each application. Our portfolio ranges from compact pumps to high performance pumps, depending on the required evacuation power

LEVEL SENSORS

The sensor architecture of the PULS (Packed Ultrasonic Level Sensor) oil level sensor consists of one single multi-chip module that integrates the ultrasonic sensor, the temperature sensor and an ASIC (Application Specific Integrated Circuit). The compactness of our sensors increases their impact and vibration resistance compared with sensors that are fitted with numerous electronic components. The ultrasonic sensor integrated in the multi-chip module transmits a signal that is reflected by the bounding surface between the motor oil and the air.

The signal's running time is measured and the filling level is calculated depending on the speed of sound in the medium. The attenuation cup attached above the multi-chip module serves to calm the medium (particularly) in the dynamic measuring range. The damping cap has openings at the base and at the tip, which allow permanent oil flow



INTELLIGENT BATTERY SENSORS

The intelligent battery sensor (IBS) from HELLA is the key element of vehicle energy management. The IBS reliably and accurately measures the battery parameters: voltage, current and temperature. Information about the battery's state of charge (SOC), state of battery health (SOH) and state of function (SOF) is calculated algorithmically from the measurements. The IBS is designed for use in starter, gel and AGM batteries to monitor in-vehicle starter or consumer batteries. The IBS can be directly integrated into the vehicle's electrical system with the standardised LIN protocol.

- Accurate measurement of voltage, current and temperature battery parameters
- Determining the battery condition parameters State of Charge (SOC), State of Battery Health (SOH) and State of Function (SOF)
- Simple electrical and mechanical integration

Energy Management



RAIN/LIGHT SENSORS

The full range of functions of the rain-light sensor (five functions: rain sensor, light sensor, solar sensor, humidity measurement, and head-up display) can only be used for passenger vehicle applications. This sensor can only be used to a limited extent in vehicles with special windshields (thick, slanted, transmission).

The optics of the second sensor are specially designed for vehicles with steep windshields and combines the rain and light recognition functions (environment and tunnel recognition).

- Fourth generation of the long-established rain sensors by HELLA
- Five functions in one product: rain, light solar and humidity measurement and adjustment of the light intensity of the head-up display
- Optimised design – extremely compact package space

Components

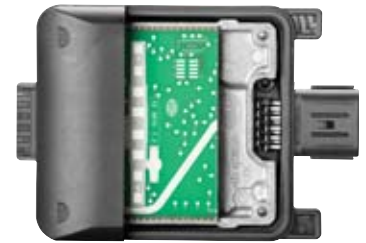

RADAR - HELLA OE PRODUCT

- First 24 GHz radar for rear end applications on the market
- Up to five functions possible:
- Blind spot monitoring, lane change assistant, rear pre-crash system, rear cross traffic alert and vehicle exit assistant
- HELLA - the first supplier of radar sensor systems on the independent aftermarket

Components

FUEL PUMPS AND FUEL FEED UNITS

- High Quality Standards
- Large number of applications
- Designed for easy mounting
- Each unit is delivered with gaskets, according to the Original Equipment requirements* (as applicable)

OTHER FEATURES AND FUNCTIONS:

- The Fuel Pump is an integral part of the Fuel Delivery System
- Delivers fuel from the tank to the engine
- They are usually electrically powered
- More power with less current draw than previous generation pumps



<https://hella.mypartfinder.com/>

WHY HELLA FUEL PUMPS?

- Original Equipment Quality
- Tight seal on coupling caps
- Double sieve with finer mesh filter
- Better quality internal parts
- Armor with Plastic-Metal and robust
- Large and good weight magnets
- Reinforced and nickel-plated casing
- Hermetic seal on coupling covers
- Relief and Check Valve
- Country of origin: China







PAGID

BRAKE SYSTEMS



BRAKEGUIDE

EASILY FIND SUITABLE PRODUCTS



<https://hella.mypartfinder.com/>

RELIANCE. TRUST. PERFORMANCE.

- **RELIANCE** = OE Expertise
- **TRUST** = strong brand names that customers trust
- **PERFORMANCE** = comprehensive, solution-oriented services



HELLA PAGID BRAKE SYSTEMS

HELLA PAGID BRAKE SYSTEMS is a joint venture between TMD Friction and Hella that combines decades of original equipment experience and more than 60 years of brake expertise in one company. Our products are manufactured by TMD Friction's Pagid division and distributed worldwide through Hella's global aftermarket organization. This joint venture links the strengths of two industry leaders in original equipment, aftermarket, and service, combining skills that compliment each other exceptionally well.

From small urban vehicles to high-performance sports cars, HELLA PAGID BRAKE SYSTEMS offers a perfect mix of safety, durability, and excellent braking convenience for any class of vehicle. This is evidenced by original equipment contracts with major automobile manufacturers worldwide. We offer a fully comprehensive range of brake products and services with excellent solutions and the quality of a strong brand. OE expertise combined with experienced and skilled aftermarket and service capabilities.

Our portfolio consists of over 14,000 products, including Brake Pads, Brake Discs, Brake Hydraulics, Clutch Hydraulics, Fluids & Chemicals, and accessories. These products meet the highest standards for OE quality and safety. Products are developed in close collaboration with leading automobile manufacturers. Before being released for sale, a new product completes up to 300,000 test kilometers and is intensively tested for braking, wear, and comfort behavior. This development know-how and in-house production facilities, including some in Germany, bring the quality of a major original equipment supplier to the aftermarket.

Products for passenger cars and light commercial vehicles



BRAKE PADS



HELLA PAGID brake pads are designed to precisely reflect the respective requirements of the various vehicle types, brake systems, engine outputs, driving loads, and braking characteristics.

- Developed based on OE knowledge
- Friction material mix of over 100 compounds
- Pad design and shims identical to OEM
- OE stopping capability
- Better Brake Laws compliant
- Consistent brake feel in all operating conditions
- 98% European coverage
- 3 Types of Materials offered:

Low-Met – High performance material for European driving conditions. Friction Value of μ : 0.35-0.5

Organic / Ceramic – High comfort material for typical driving conditions in North America and Asia.

Friction Value of μ : 0.30-0.40

Semi-Met – Long life material for US driving conditions and vehicles requiring greater stopping power.

Friction Value of μ : <0.40

BRAKE ROTORS



HELLA PAGID offers a full range of High Carbon (GG15 & GG20) brake rotors that are 100% fully coated with premium zinc rust protection coating. Rotors are manufactured according to European OE specifications (AM1 & AM2) and come in a 1-piece (Integral) or 2-piece (Composite) construction.

- Increased heat conductivity through increased carbon content
- Less fading and quiet braking
- Reduced braking noise
- Higher driving comfort with reduced machining tolerances
- Better handling, driving comfort and less load on suspension parts through reduction of unsprung masses
- Increased fuel efficiency through weight reduction by up to 20 %

VIDEO



<https://youtu.be/tfE8LZhA6jY>



WEAR SENSORS BRAKE CALIPERS



HELLA PAGID'S WEAR SENSOR

HELLA PAGID's Wear Sensor range is produced 100% in Europe. Each wear sensor is meticulously produced with injection molding processes to withstand the harshest conditions.

- Injection Molded for durability and quality
- Excellent thermal insulation
- Highly resistant to heat
- 100% made in Europe
- Manufacture for OE
- 130+ wear sensors
- 90% European coverage

HELLA PAGID BRAKE CALIPERS

Current program covers the top applications in the European Independent Aftermarket and European nameplates in the US. All products undergo extensive testing to ensure compliance with OE standards.

- 100 % End-of-Line inspections
- 100 % Pressure Test (High- & Low-pressure leak testing)
- 100 % Handbrake function testing
- Premium surface treatment for cast iron calipers
- Salt spray tests of every batch (calipers, pistons and guide pins)
- Audited processes
- Endurance/Lifetime Run



COMMERCIAL VEHICLES RANGE



The HELLA PAGID commercial vehicles range has been designed to leverage OE Brake competence with unique market experience to provide the best possible brake combination for your customers light commercial vehicles. Starting with increased stopping power from European produced pads and finishing off with High Carbon rotors to dissipate heat to allow optimum braking and increased longevity.

- European stopping power for light commercial applications due to high weight and an LCV's top-speed of ~105-110 miles on the German "Autobahn"
- High Carbon Rotors Designed to absorb and dissipate heat more effectively then iron rotors
- European Wear Sensor Program
- Heavy Duty Police and Taxi Pads
- OE quality

**Download Light Commercial
vehicles brochure**



DIGITAL SERVICES

This section is devoted to helping customers and visitors navigate to the correct sites according to the individual needs of original equipment, distributors, dealers and professional repair shops.

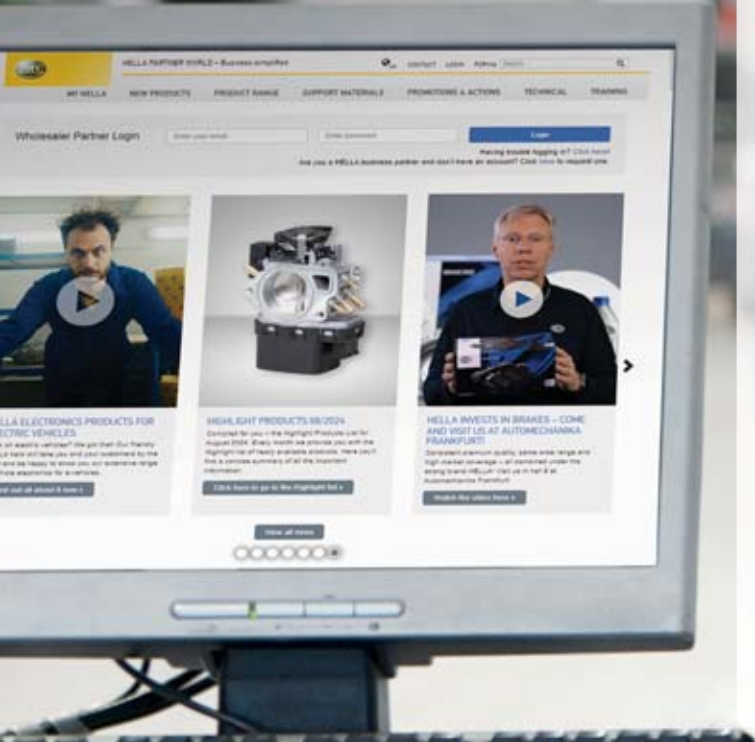



HELLA PARTNER WORLD
 Real-time product availability
 Online Ordering Open Order Reporting (See Status by PO, Ship Date, Back Order Lead Times, and more!)
 Customer Specific Pricing (Jobber / WD / Net)
 Order Tracking information (LTL, UPS and FedEx)
 Digital Product Images with Application Data and OE X-references
 Access invoices and credit memos
 HPW Monthly Newsletter with exclusive Promotions



HELLA TECH WORLD
 Online platform for workshops
 Vehicle-specific repair Information
 Technical information
 Technical videos
 Responsive design



HELLA PART FINDER
 All vehicle specific parts at a glance



www.hellausa.com
 Company information, online catalogs (PDFs)



www.myhellalights.com
 Auxiliary Lights, signal lighting, bulbs, horns, wiper blades, light bars and accessories

SOCIAL MEDIA

- Facebook www.facebook.com/hella.usa
- Facebook www.facebook.com/hellamarine
- YouTube www.youtube.com/myhellalights
- Instagram www.instagram.com/hella.usa
- LinkedIn www.linkedin.com/company/hella

APPS AND ONLINE TOOLS FOR SMARTPHONES AND TABLETS

www.hella.com/apps



Horns



Auxiliary Lighting
ELIVER



Electronics
ELIGRO



BrakeGuide



NightDrive
(Game)

APPLICATION DATA					
MAPPING OF INFORMATION	OPTICAT	EPICOR	WHI	DCI	SDC
HELLA Product Line	Code	Code	Code	Code	Code - Under HELLA, Inc.
Automotive Bulbs	HELLA ALL	HES	HLA	Only bulbs and wiper blades	HELLA
Vehicle Specific Lighting	HELLA ALL	HES	HLA		HELLA
Fuel Pumps	HELLA ALL	HEV	HLA		HELLA
Windshield Wipers	HELLA ALL	HEM	HLA	Only bulbs and wiper blades	HELLA
Electrics and Electronics	HELLA ALL	HEP	HLA		HELLA
Optilux	HELLA OPTILUX	OPL	HLA	Optilux Lighting	Optilux
HELLA Pagid Brakes	HELLA PAGID BRAKE SYSTEM	HEA	HPD		HELLA Pagid
HELLA Pagid Silver	HELLA PAGID SILVER	HED	HPN		HELLA Pagid
Pierburg by HELLA	HELLA PIERBURG	PGP	PIG		Pierburg

GET FREE TECHNICAL TRAINING

HELLA TECH WORLD

Prepare your automobile garage for the future. At HELLA TECH WORLD you will find all our technical expert knowledge in the fields of lighting, electrical, electronic, thermal management, brake systems and vehicle diagnostics. And best of all this content is available 24/7 for you and your customers for FREE!

Register today and start to acquire the knowledge that will give you a real advantage and competitive edge for greater success!

Visit:

www.hella.com/techworld



**REGISTER TODAY
FOR FREE!**



Scan this QR code from your Smartphone or Tablet to enter.



www.hella.com/techworld

Multiple tools available:



Know-how Tool



Technical Information

Here is a summary of the most important basic terms in lighting technology and the respective units of measure for the evaluation of the properties of bulbs and lights.

Luminous flux Φ

Unit: Lumen [lm]

Luminous flux F is the term used to describe the complete light output radiated from a light source

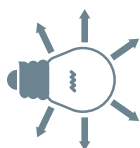

Luminous intensity I

Unit: Candela [cd]

Part of the luminous flux which radiates in a certain direction.



Illuminance E

Unit: Lux [lx]

Illuminance E specifies the ratio of the impinging luminous flux to the illuminated surface. Illuminance is 1 lx when a luminous flux of 1 lm impinges an area of 1 m².

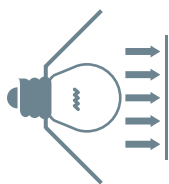

Luminance L

Unit: Candela per square metre [cd/m²]

Luminance L is the impression of brightness the eye has from a luminous or illuminated surface.



Light output η

Unit: Lumen per Watt [lm/W]

Light output η specifies the rate of efficiency with which the consumed electrical power is transformed into light.

Light sources

Light sources are radiators of temperatures which produce light through heat energy. This means the more strongly a light source is heated up, the higher its luminous intensity will be. The low efficiency (8 % light radiation) only allows a relatively low light output in comparison with gas discharge lamps (28 % light radiation). Recently, LEDs have started to be used as light source in front headlights

Colour temperature K

Unit: Kelvin [K]

Kelvin is the unit for colour temperature. The higher the temperature of a light source, the greater the blue share in the colour spectrum and the smaller the red share. A bulb with warm white light has a colour temperature of approx. 2,700 K. In contrast, a gas discharge lamp (D2S) with a colour temperature of 4,250 K produces cold white light which is, however, nearer to the colour of daylight (approx. 5,600 K).

Influence factors on a light source:

Despite the regeneration inside the lamp, the tungsten filament is gradually consumed, which limits its useful life. The durability and luminous efficiency depend strongly, between other factors, of the supply voltage present. The following empirical rule applies: if the supply voltage of a lamp is increased by 5%, the luminous flux increases by 20%, but at the same time the useful life is shortened by half.

Lumen lm:

It is the unit of the International Measurement System to measure the luminous flux, a measure of the light output emitted by the source. The luminous flux differs from the radiant flux in that the first it contemplates the variable sensitivity of the human eye to the different wavelengths of light and the latter involves all the electromagnetic radiation emitted by the light source according to the laws of Wien and Stefan-Boltzmann regardless of whether such radiation is visible or not.

$$1\text{lm} = 1\text{cd} \cdot \text{sr} + 1\text{lx} \cdot \text{m}^2$$

Candela cd:

It is the unit of the International System of Measures to measure light intensity. It is defined as: The light intensity is a given direction, from a source that emits a monochromatic radiation of 540 x 10¹² hertz frequency and of which the intensity radiated in that direction is 1/683 W watts per stereo radian.

Bulbs markings

Vehicle bulbs have to be standardised in compliance with ECE-R37 or R99. This makes bulb replacement possible while at the same time avoiding mix-ups with other bulbs. The following lettering can be found on bulbs:

- Name of the manufacturer
- 6 or 6 V, 12 or 12 V, 24 or 24 V stands for the nominal voltage in compliance with ECE regulation 37.
- H1, H4, H7, P21 W stands for the international category description of ECE-standardised bulbs e.g. 55 W.
- E1 indicates which country the light source has been tested and approved in. "1" stands for Germany.
- "DOT" means that it is also approved for use on the American market.
- "U" stands for UV-reduced bulbs, according to ECE. The bulbs are used in headlights with plastic cover lenses, for example..
- The approval mark granted by the appropriate authorities e.g. E1 (Federal Department of Motor Vehicles in Flensburg) is inscribed on the bulb and is either 37 R (E1) + a five-digit number or only (E1) + a three-digit number (sometimes alphanumeric codes, see illustration).
- Most bulbs have a coded manufacturer's mark. This makes traceability to the manufacturer possible.
- Since not all bulbs have enough room for the markings, the legislator prescribes only the following obligatory information: manufacturer, capacity, test mark and approval mark.

Tips for dealing with light sources

- Xenon headlights require high voltage for ignition, which is why the ballast voltage supply plug should always be removed before any work is carried out on the headlights.
- When replacing bulbs, never touch the new glass bulb since fingerprints will be burnt on and make the bulb opaque.
- If a xenon bulb breaks in a closed room (repair shop) the room should be ventilated to prevent a health hazard due to toxic gases. D3 and D4 xenon lamps do not contain mercury and are therefore more environmentally compatible.
- Standard filament and halogen bulbs do not contain any materials which are problematical from an environmental point of view and can be disposed of with normal household waste.
- In D3 and D4 xenon lamps, the mercury was replaced with non-toxic zinc iodide. These bulbs can be disposed of with normal household waste.

Type approval numbers on the headlight

National and international design and operating regulations apply for the manufacture and testing of vehicle lighting equipment. Special approval marks exist for headlights and can be found on the cover lens or on the housing.

One example

The following can be found on a cover lens HC/R 25 E1 02 A 44457:

- Code HC/R means: H for Halogen-, C for low beam and R for high beam.
- The slash between C and R means that low beam and highbeam cannot be switched on simultaneously (H4 main headlights).
- The subsequent reference number provides information about the luminous intensity of the spotlight.
- The code E1 means that the headlight has been approved in Germany.
- 02 A indicates that there is a clearance light (parking light)
- (A) in the headlight, the regulations for which have been revised twice (02) since publication.
- The five-digit number at the end is the type approval number which is assigned individually for every headlight design approval.

Help in deciphering the combinations of numbers and letters on headlights

ECE regulation 1

- A Clearance light
- B Fog light
- C Low beam
- R High beam
- CR High and low beam
- C/R High or low beam

ECE regulation 8, 20 (H4 only)

- HC Halogen low beam
- HC Halogen high and low beam
- HC/R Halogen high or low beam

ECE regulation 98

- DC Xenon low beam
 - DR Xenon high beam
 - DC/R Xenon high or low beam
- Simultaneous operation is prohibited.

ECE regulation 123

- X Advanced Frontlighting System

WHAT IP PROTECTION CATEGORIES ARE THERE?

Protection category IP 5K4K

Dust may only penetrate to such an extent that function and safety are not impaired. Water that is sprayed from every direction at increased pressure against the housing may not have any damaging effect: water pressure approx. 4 bar.

Protection category IP 5K9K

Dust may only penetrate to such an extent that function and safety are not impaired. Water that is directed from highpressure / steam-jet equipment onto the housing must not have any damaging effect: water pressure approx. 100 bar.

Protection category IP 6K4K

Dust must not penetrate. Water that is sprayed from every direction at increased pressure against the housing must not have any damaging effect: water pressure approx. 4 bar.

Protection class IP 67

Dust must not penetrate. No water may penetrate, even if the device is submersed for some time.

Degree of protection IP 6K9K

Dust must not penetrate. Water that is directed from highpressure / steam-jet equipment onto the housing must not have any damaging effect: water pressure approx. 100 bar

HELLA Automotive Sales, Inc.

201 Kelly Drive
Peachtree City, GA, 30269
Tel.: +1 (877) 224-3552
Fax: +1 (770) 631-7574
www.hellausa.com
www.myhellalights.com

HELLAMEX, S.A. de C.V.

Carretera México Querétaro Km 30,
Bodega 2B y Barranca Honda,
San Martín Obispo, Cuautitlán Izcalli,
Edo. de México. C.P. 54763
Tel. Ventas: +52 (55) 5321-1390
Servicio Técnico: 01 800 221-0471
hellamex@hella.com
www.hellamex.com

HELLA do Brasil Automotive Ltda.

Rua Bom Pastor, 2224 - 15º andar
São Paulo, SP
04203-002 Brasil
Telefone: +55 (11) 2627-7800
info.brasil@hella.com
www.hella-brasil.com

© HELLA GmbH & Co. KGaA. Lippstadt
999142492 10.2024
Printed in USA